

Programmable Multi-Axis Controller

Startup Guide for EtherCAT Coupler Unit / Digital I/O Unit (IDEv4)

CK5M-CPU1□1

CK3M-CPU1□1

CK3E-□□□□

Startup
Guide

NOTE

1. All rights reserved. No part of this publication may be reproduced, stored in a retrieval system, or transmitted, in any form, or by any means, mechanical, electronic, photocopying, recording, or otherwise, without the prior written permission of OMRON.
2. No patent liability is assumed with respect to the use of the information contained herein.
Moreover, because OMRON is constantly striving to improve its high-quality products, the information contained in this manual is subject to change without notice.
3. Every precaution has been taken in the preparation of this manual. Nevertheless, OMRON assumes no responsibility for errors or omissions.
Neither is any liability assumed for damages resulting from the use of the information contained in this publication.

Trademarks

- Sysmac and SYSMAC are trademarks or registered trademarks of OMRON Corporation in Japan and other countries for OMRON factory automation products.
- Microsoft, Windows, Excel, Visual Basic, and Microsoft Edge are either registered trademarks or trademarks of Microsoft Corporation in the United States and other countries.
- EtherCAT® is registered trademark and patented technology, licensed by Beckhoff Automation GmbH, Germany.

Other company names and product names in this document are the trademarks or registered trademarks of their respective companies.

Copyrights

- Microsoft product screen shots used with permission from Microsoft.
- This product incorporates certain third party software. The license and copyright information associated with this software is available at http://www.fa.omron.co.jp/nj_info_e/.

Contents

- 1. Related Manuals 4**
- 2. Terms and Definitions 5**
- 3. Precautions 6**
- 4. Overview 7**
- 5. Applicable Devices and Device Configuration 8**
 - 5.1. Applicable Devices 8
 - 5.2. Device Configuration 9
- 6. EtherCAT Connection Procedure 10**
 - 6.1. Workflow 10
 - 6.2. Preparation for the Controller Setup 11
 - 6.3. Installation of ESI Files 16
 - 6.4. EtherCAT Communications Setup 17
 - 6.5. Controller Settings 27
- 7. Appendix Saving and Loading a Project 32**
 - 7.1. Saving a Project 32
 - 7.2. Loading and Downloading a Project 34
- 8. Appendix Troubleshooting 37**
 - 8.1. Factors Causing EtherCAT Communications To Be Unavailable, and Corrective Actions
..... 37
 - 8.2. How to Check for Errors 38
- 9. Appendix ECAT[i] Structure Elements 41**
- 10. Revision History 42**

1. Related Manuals

To ensure system safety, always read and follow the information provided in all *Safety Precautions* and *Precautions for Safe Use* in the manuals for the devices that are used in the system.

The following shows the manuals for OMRON Corporation (hereafter referred to as OMRON) and Delta Tau Data Systems, Inc (DT).

Manufacturer	Manual No.	Model	Manual name
OMRON	I610-E1	Model CK3E-1□□10	CK3E-series Programmable Multi-Axis Controller Hardware User's Manual
OMRON	O036-E1	Model CK3M-CPU1□□1 Model CK5M-CPU1□□1	CK3M-series Programmable Multi-Axis Controller Hardware User's Manual
OMRON	W519-E1	Model NX-ECC203	EtherCAT® Coupler Unit User's Manual
OMRON	W521-E1	Model NX-ID□□□□ Model NX-IA□□□□ Model NX-OC□□□□ Model NX-OD□□□□ Model NX-MD□□□□	Digital I/O Unit User's Manual
DT	O014-E	-	Power PMAC User's Manual
DT	O015-E	-	Power PMAC Software Reference Manual
DT	O016-E	-	Power PMAC IDE Users Manual

2. Terms and Definitions

Term	Explanation and Definition
Slave	Slaves are devices connected to EtherCAT. There are various types of slaves such as servo drivers handling position data and I/O terminals handling the bit signals.
Object	Represents information such as in-slave data and parameters.
PDO communications (Communications using Process Data Objects)	One type of EtherCAT communications in which process data objects (PDOs) are used to exchange information cyclically and in realtime. This is also called "process data communications".
PDO Mapping	The association of objects used for PDO communications.
PDO Entry	PDO entries are the pointers to individual objects used for PDO mapping.
ESI file (EtherCAT Slave Information file)	An ESI file contains information unique to the EtherCAT slaves in XML format. You can load ESI files into the Power PMAC IDE, to easily allocate slave process data and make other settings.
ENI file (EtherCAT Network Information file)	An ENI file contains the network configuration information related to EtherCAT slaves.
Power PMAC IDE	This computer software is used to configure the Controller, create user programs, and monitor the programs. PMAC is an acronym for Programmable Multi-Axis Controller.

3. Precautions

- (1) Understand the specifications of devices that are used in the system. Allow some margin for ratings and performance. Provide safety measures, such as for installing a safety circuit, in order to ensure safety and minimize the risk of abnormal occurrences.
- (2) To ensure system safety, always read and follow the information provided in all *Safety Precautions* and *Precautions for Safe Use* in the manuals for each device that is used in the system.
- (3) The user is encouraged to confirm the standards and regulations that the system must conform to.
- (4) It is prohibited to copy, reproduce, or distribute a part or the whole of this document without the permission of OMRON Corporation.
- (5) The information contained in this document is current as of September 2022. It is subject to change without prior notice for improvement purposes.

The following notations are used in this document.

 WARNING	Indicates a potentially hazardous situation which, if not avoided, may result in minor or moderate injury, or may result in serious injury or death. Additionally, there may be severe property damage.
---	---

 Caution	Indicates a potentially hazardous situation which, if not avoided, may result in minor or moderate injury, or property damage.
--	--



Precautions for Correct Use

Precautions on what to do and what not to do to ensure correct operation and performance.



Additional Information

Additional information to read as required.

This information is provided to increase understanding or make operations easier.

Symbols



The filled circle symbol indicates operations that you must carry out. The specific operation is shown in the circle and explained in text. This example indicates a “general precaution” for something that you must carry out.

4. Overview

This document describes the procedures used to connect the OMRON High EtherCAT Coupler Unit model NX-ECC203 (hereafter referred to as the Slave) using OMRON Programmable Multi-Axis Controller model CK3E-□□□□/ CK3M-CPU1□1/CK5M-CPU1□1 (hereafter referred to as the Controller) and EtherCAT, as well as for checking the connection.

Refer to *Section 6. EtherCAT Connection Procedure* to learn about the setting methods and key points to perform PDO communications via EtherCAT.

5. Applicable Devices and Device Configuration

5.1. Applicable Devices

The applicable devices are as follows:

Manufacturer	Name	Model
OMRON	Programmable Multi-Axis Controller	Model CK3E-□□□□
OMRON	Programmable Multi-Axis Controller	Model CK3M-CPU1□1 Model CK5M- CPU1□1
OMRON	EtherCAT Coupler Unit	Model NX-ECC203
OMRON	Digital I/O Units	Model NX-ID□□□□ Model NX-IA□□□□ Model NX-OC□□□□ Model NX-OD□□□□ Model NX-MD□□□□



Precautions for Correct Use

Use model NX-ECC203 Version 1.5 or later for the EtherCAT Coupler Unit.
Models NX-ECC201 and NX-ECC202 cannot be used.



Precautions for Correct Use

In this document, the devices with models and versions listed in *Section 5.2* are used as examples of applicable devices to describe the procedures to connect the devices and check their connections.

You cannot use devices with versions lower than the versions listed in *Section 5.2*.

To use the devices mentioned above with models not listed in *Section 5.2* or versions higher than those listed in *Section 5.2*, check the differences in the specifications by referring to the manuals before operating the devices.



Additional Information

This document describes the procedures to establish the network connections. It does not provide information on operations, installations, wiring methods, device functionalities, or device operations, which are not related to the connection procedures. For more information, refer to the manuals or contact your OMRON representative.

5.2. Device Configuration

The hardware components to reproduce the connection procedures in this document are as follows:

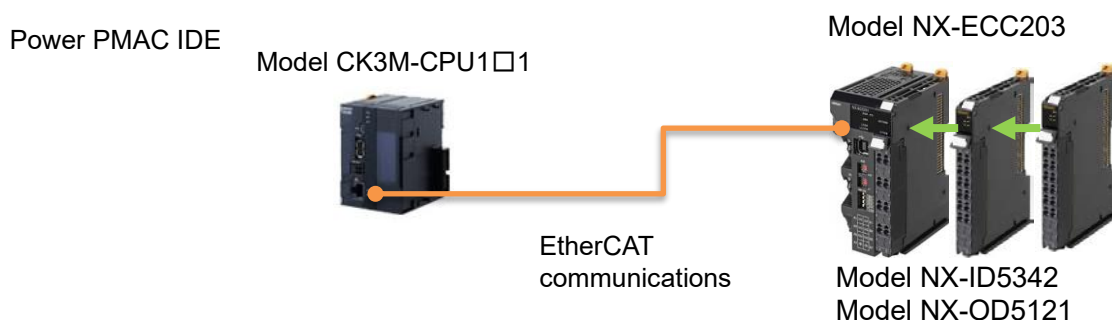

Manufacturer	Name	Model	Version
OMRON	Programmable Multi-Axis Controller	Model CK3M-CPU1□1	Ver.2.7
OMRON	EtherCAT Coupler Unit	Model NX-ECC203	Ver.1.5
OMRON	Digital Input Unit	Model NX-ID5342	Ver.1.0
OMRON	Digital Output Unit	Model NX-OD5121	Ver.1.0
OMRON	Ethernet cable (with industrial Ethernet connector)	Model XS5W-T421-□M□-K	
DT	Power PMAC IDE	-	Ver.4.6

Precautions for Correct Use

Prepare the ESI file described in this section in advance. Contact your OMRON representative for information on how to procure the ESI file.

Precautions for Correct Use

Do not share the connection line of EtherCAT communications with other Ethernet networks.
Do not use devices for Ethernet such as a switching hub.
Use the Ethernet cable (double shielding with aluminum tape and braiding) of Category 5 or higher, and use the shielded connector of Category 5 or higher.
Connect the cable shield to the connector hood at both ends of the cable.

Additional Information

This document describes model CK3M-CPU1□1 as an example. The same procedures can apply to model CK3E-□□□□/ CK5M-CPU1□1.

6. EtherCAT Connection Procedure

This section describes the procedure for connecting the Controller with the Slave via EtherCAT. The description assumes that the Controller is set to factory default.

6.1. Workflow

Take the following steps to operate the PDO communications via EtherCAT after connecting the Controller with the Slave via EtherCAT.

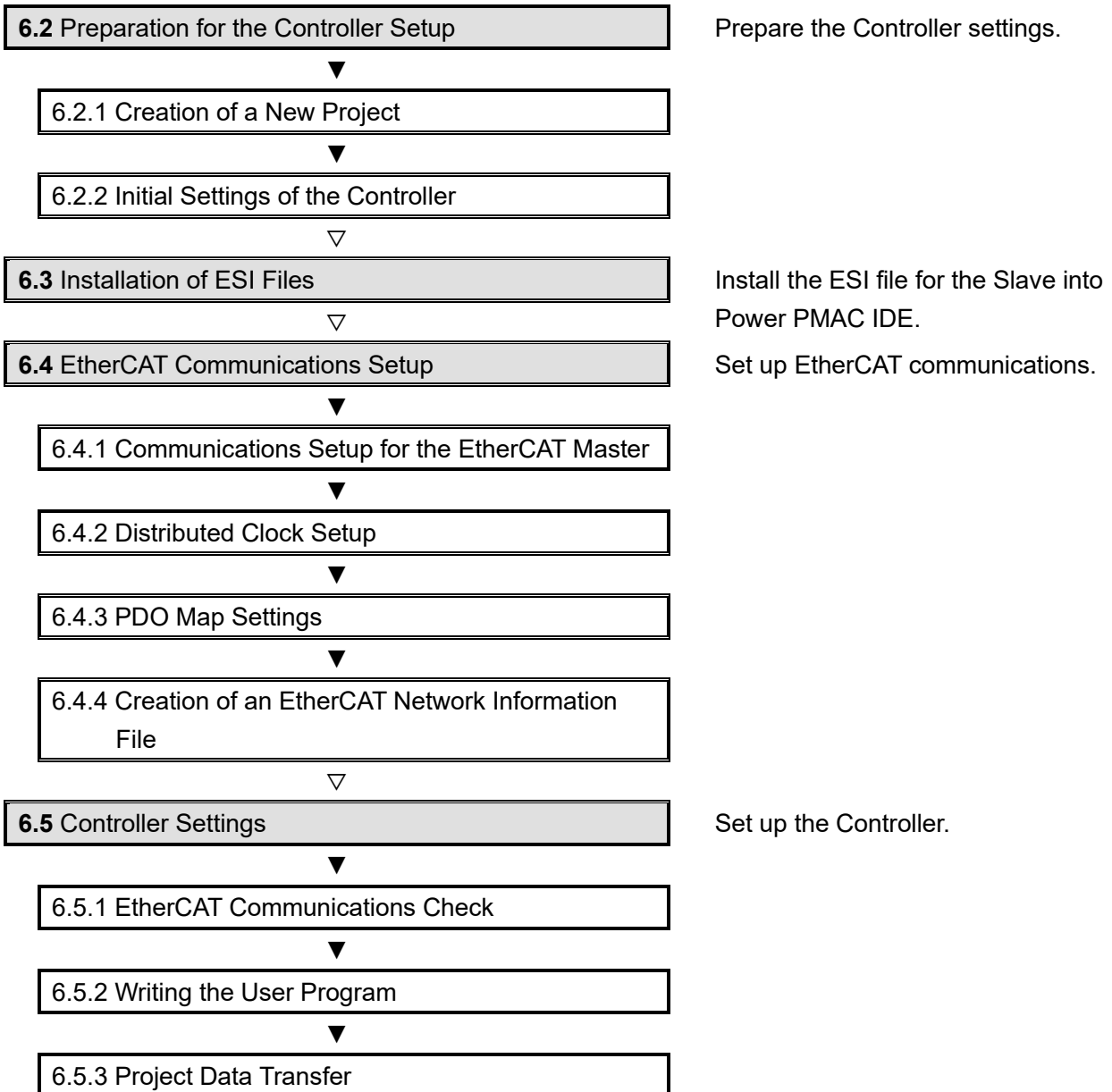

6.2. Preparation for the Controller Setup

Prepare the Controller settings.

Install Power PMAC IDE and Acontis EC-Engineer on the computer in advance.

6.2.1. Creation of a New Project

1 Turn on the power to the Controller.

2 Start Power PMAC IDE.

* If the dialog for confirming access rights appears upon start-up, select starting of Power PMAC IDE.



3 The Communication screen appears. Specify the IP address of the destination Controller and click **Connect**.

* The IP address of the Controller is set to "192.168.0.200" by default.
* If necessary, change the Windows IP address to "192.168.0.X".

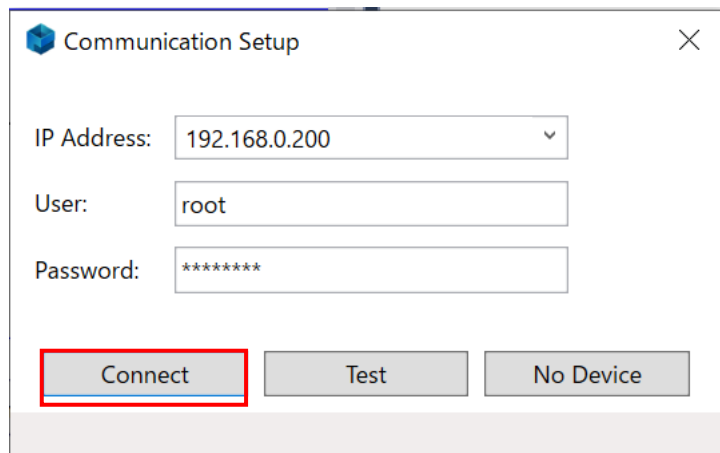

4 Power PMAC IDE starts, and is online to the Controller.

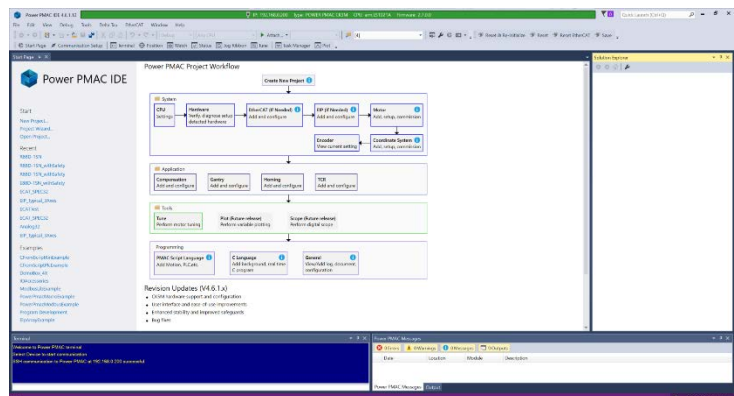

- 5** From the **File** menu, select **New** then **Project**.

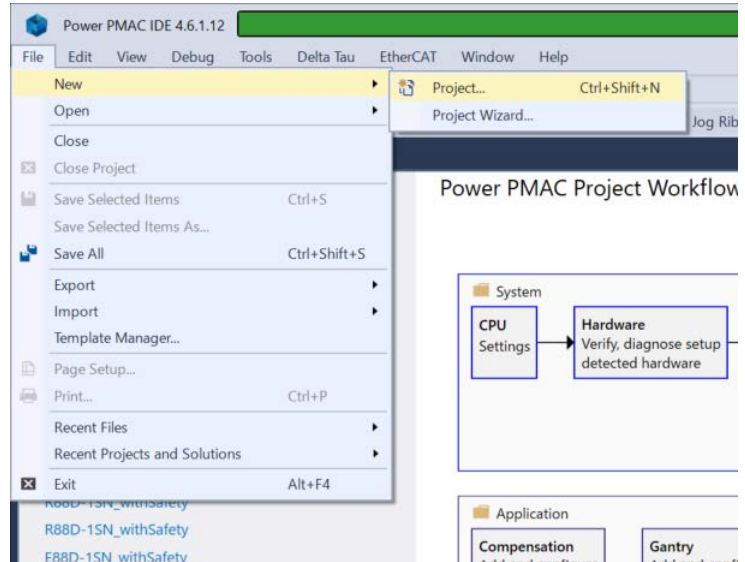

- 6** Enter a project name and location, and select **OK**.

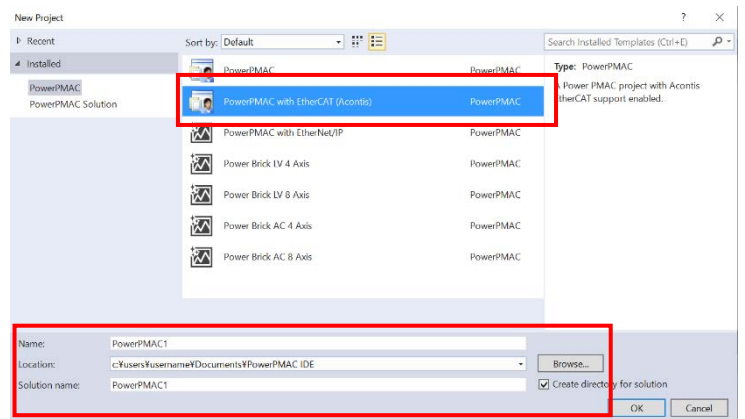

6.2.2. Initial Settings of the Controller

Configure the initial settings for the Controller.



Precautions for Correct Use

Configuring the initial settings clears all data in the Controller memory. Back up necessary data in advance.

- 1 In the Terminal tab page, type the \$\$\$** command to reset the Controller to factory default.

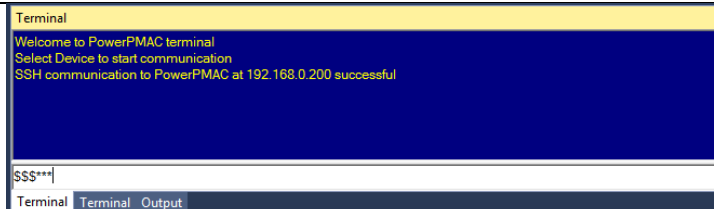

- 2 Select **System – CPU – System** in the Solution Explorer.

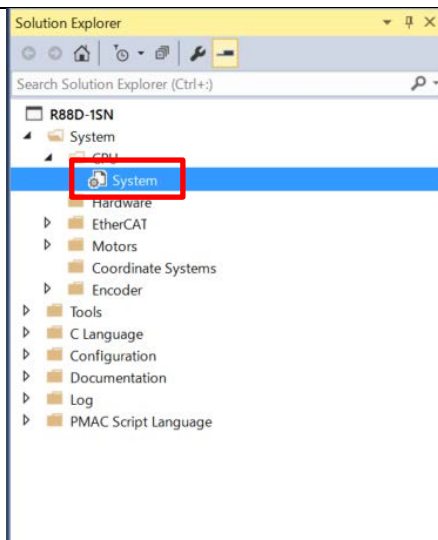

- 3 Select **Clock Settings**.

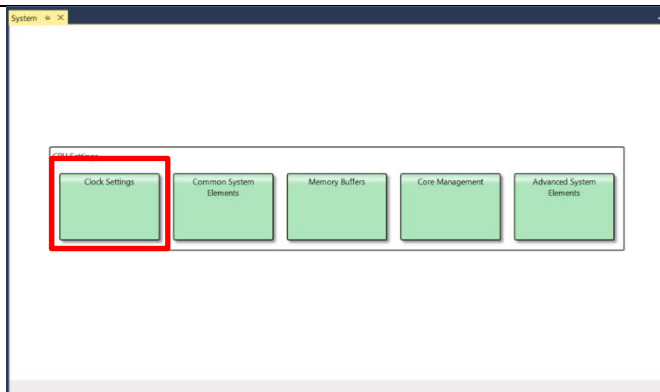

4 Specify Servo Frequency.

Select the **Servo Frequency** setting from 4 kHz, 2 kHz, or 1 kHz.

* Servo Frequency is set to 1 kHz for the example in this document.

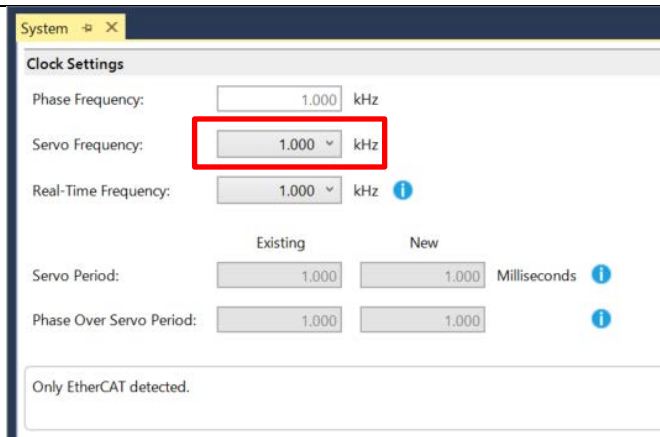

5 Click the **Accept** button.

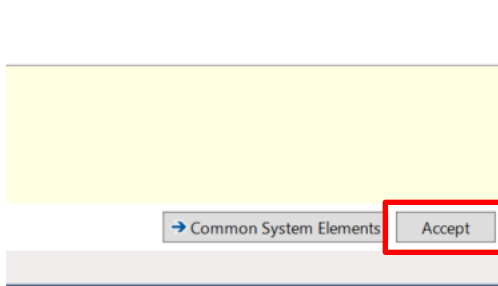

6 If you have changed the servo frequency setting, type the **SAVE** command in the Terminal tab page of Power PMAC IDE. When complete, the “Save Complete” message appears in the Terminal tab page.

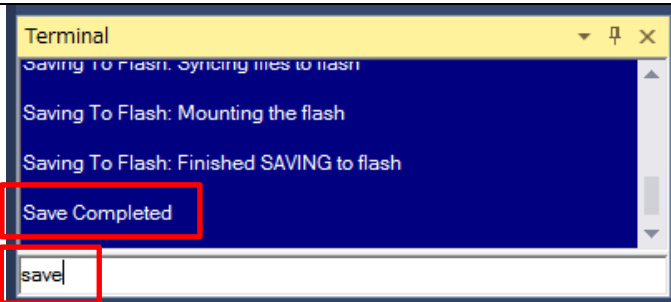

7 Click **Delta Tau – Communication Setup** on the toolbar to display the Communication Setup dialog box.

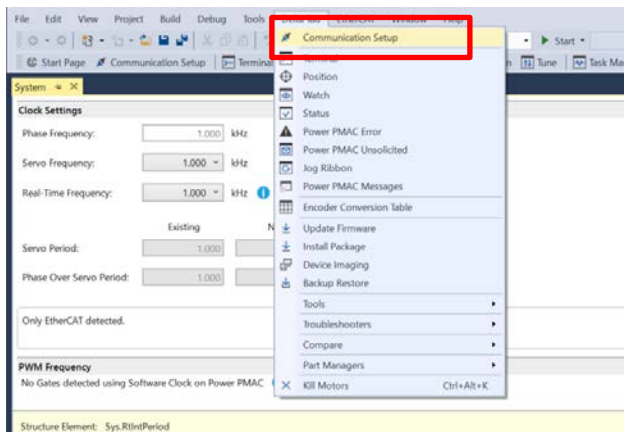

8 In the Device Properties dialog box, click the **No Device** button.

This operation sets the Controller to the offline state.

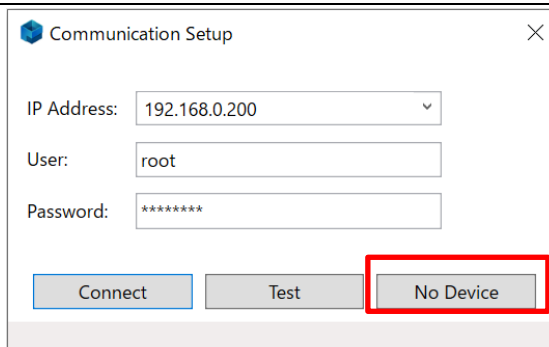

9 The Controller restarts.

The servo frequency that has been set is reflected.

10 Wait until the startup process of the Controller is complete. Then click **Delta Tau** –

Communication Setup on the toolbar to display the Device Properties dialog box.

In the Communication Setup dialog box, click the **Connect** button.

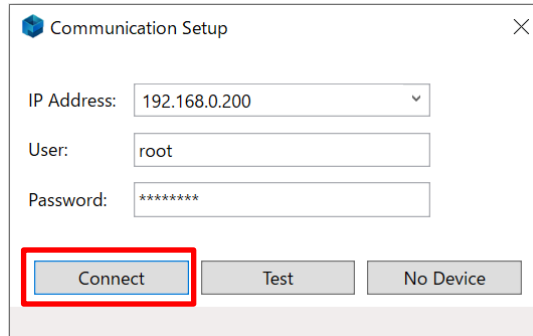

Communication Setup

IP Address: 192.168.0.200

User: root

Password: *****

Connect Test No Device

This operation sets the Controller to the online state.

6.3. Installation of ESI Files

Install the ESI file for the Slave into Power PMAC IDE.



Precautions for Correct Use

Prepare the ESI file described in this section in advance. Contact your OMRON representative for information on how to procure the ESI file.

- 1 From the **EtherCAT** menu of Power PMAC IDE, select **ESI Manager**.

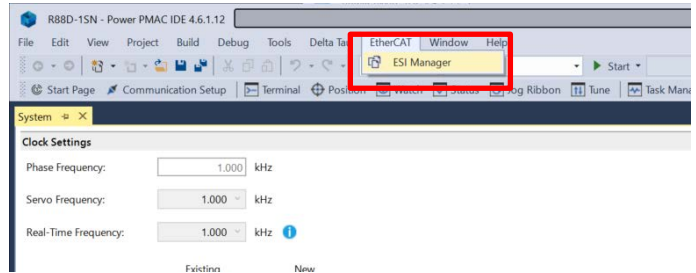

- 2 Confirm that *Omron NX_Coupler.xml* is registered in the ESI file list of ESI Manager.

If it is not yet registered, click **Add File** and register *Omron NX_Coupler.xml*.

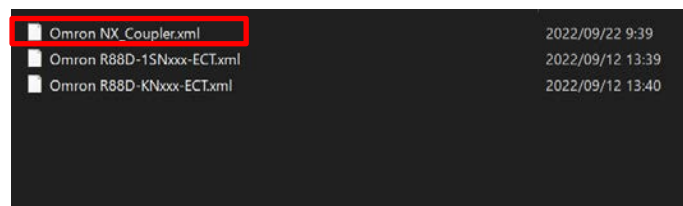
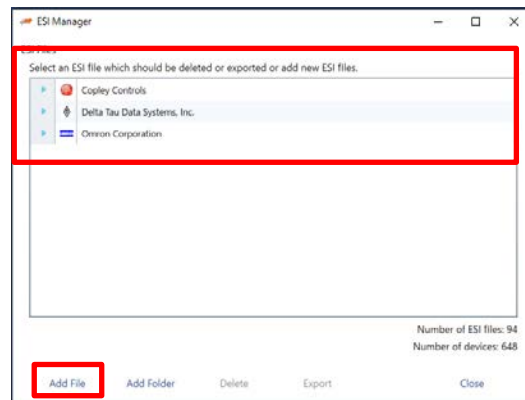

- 3 Click **Close** to close the ESI Manager.

6.4. EtherCAT Communications Setup

Set up EtherCAT communications.



Precautions for Correct Use

Before taking the following steps, make sure that the devices are connected via an Ethernet cable. If they are not connected, turn OFF the power to the devices, and connect the Ethernet cable.

6.4.1. Communications Setup for the EtherCAT Master

- 1 Connect the Controller with slave devices using an Ethernet cable.

* Refer to the manuals for slave devices to configure them.

- 2 Select System – EtherCAT in the Solution Explorer and right-click on EtherCAT, then select Add EtherCAT Master(Acontis).

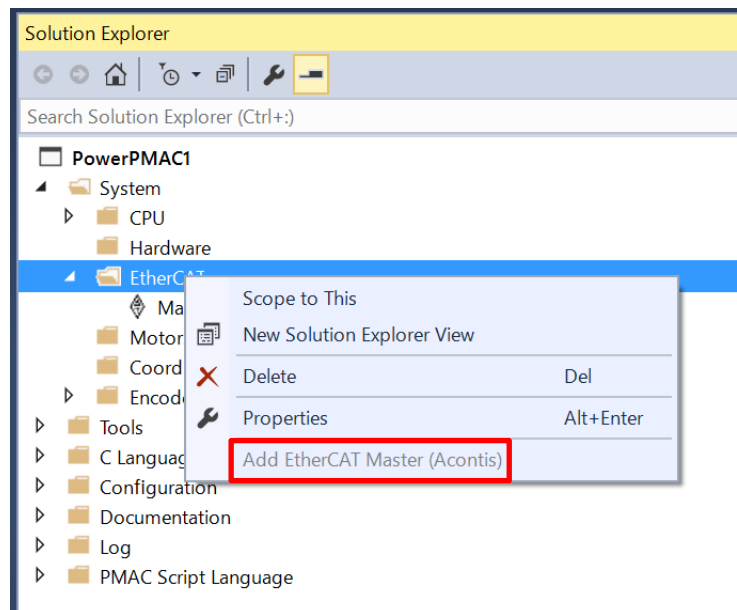

3 Master0 (Deactivated) is added to Solution Explorer.

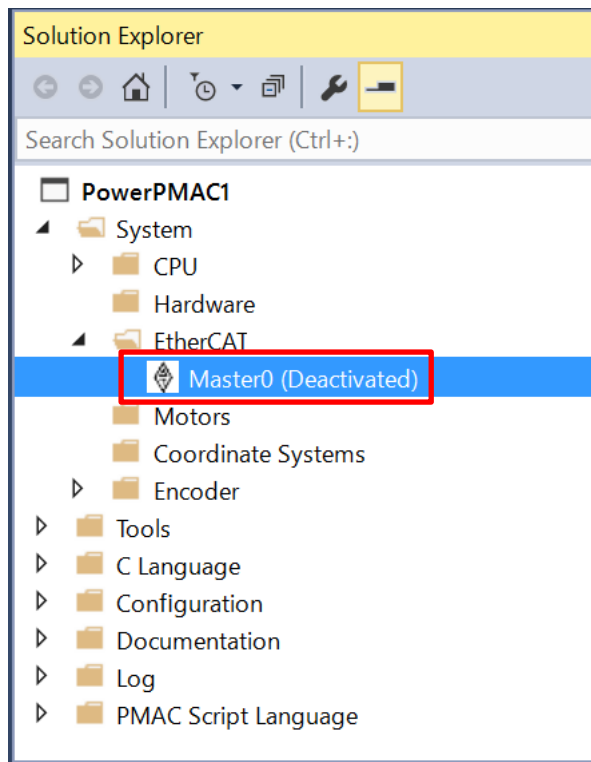

4 In the Master tab page, specify a communication period for **Cycle Time [us]**.

* You must specify the communication period in accordance with the servo frequency of the Controller. 1000 us is set in this document.

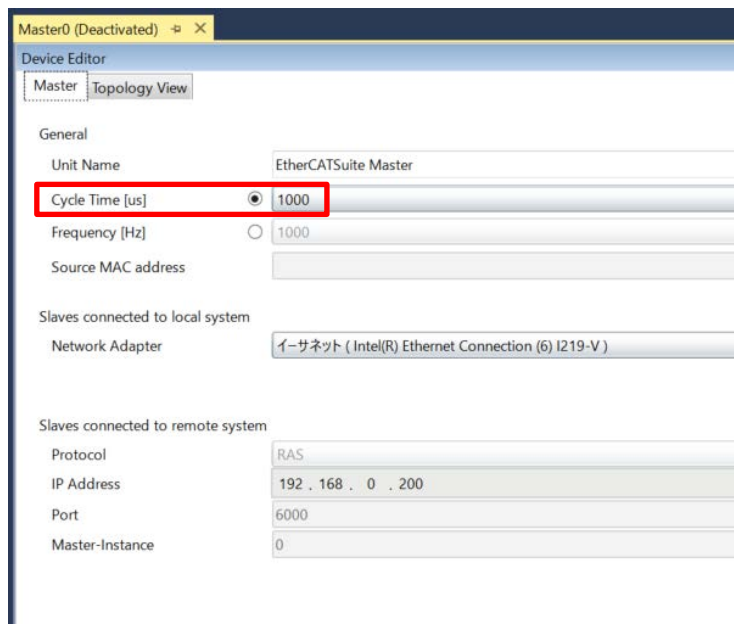

Correspondence between the servo frequencies of the Controller and communication periods is as follows:

- 4 kHz : 250 us
- 2 kHz : 500 us
- 1 kHz : 1000 us

- 5** Select **System – EtherCAT** in the Solution Explorer and right-click on **Master0 (Deactivated)**, then select **Scan EtherCAT Network**.

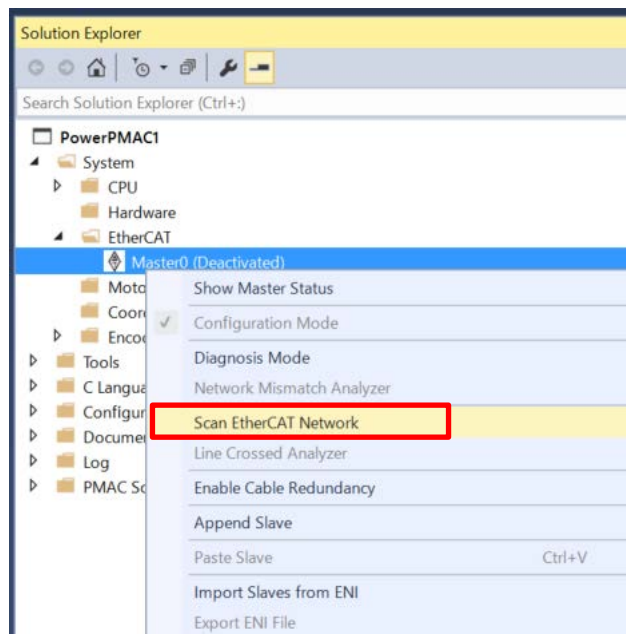

- 6** Make sure that the slave is displayed in the Solution Explorer.

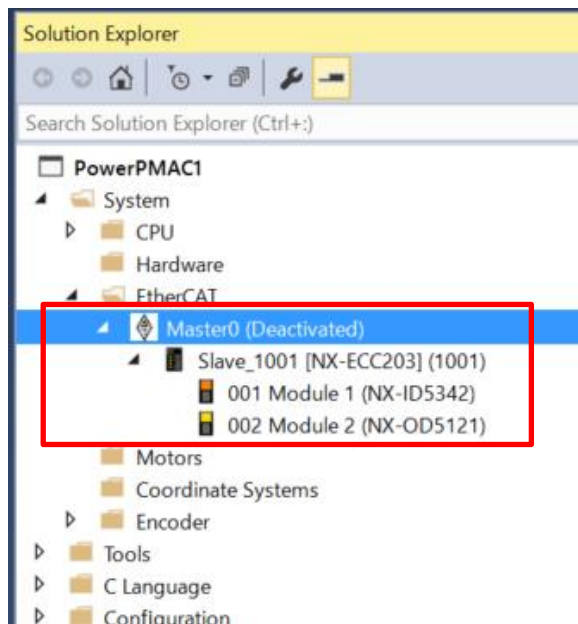

6.4.2. Distributed Clock Setup

1 Setting Distributed Clocks (DC) for Master

In the Master0 (Deactivated) tab page, select **Distributed Clocks** tab.

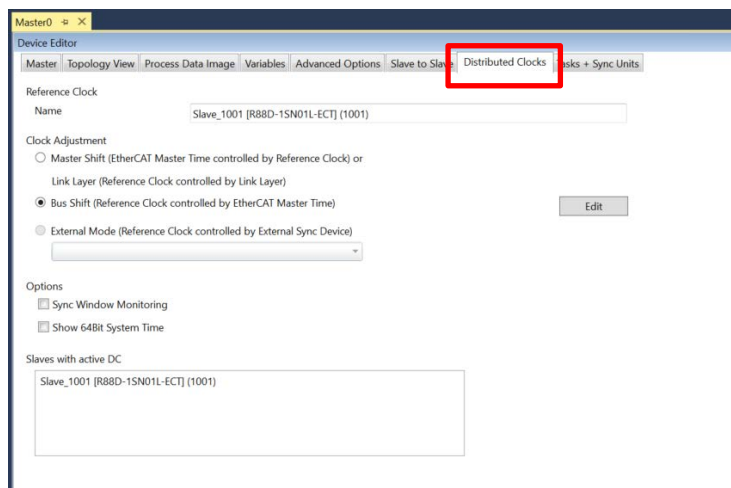
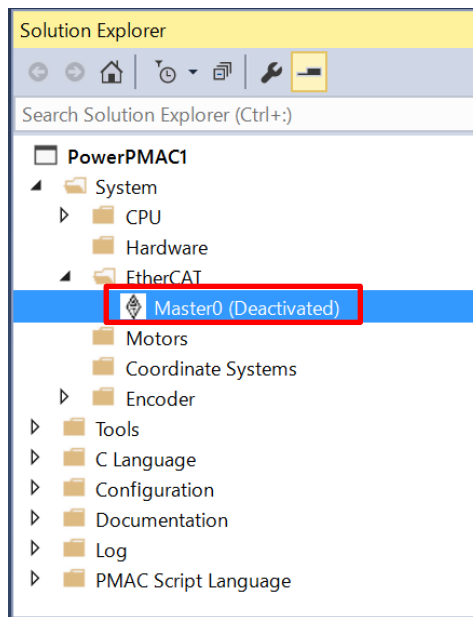

2 Select Master Shift (EtherCAT Master Time controlled by Reference Clock).

Master Time controlled by Reference Clock).

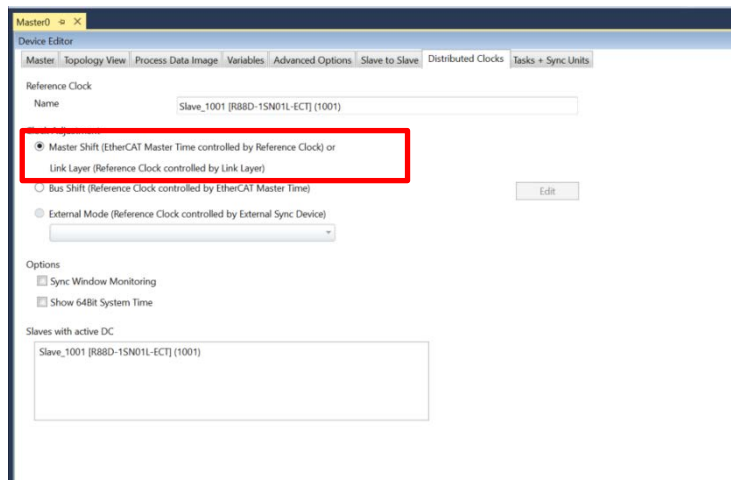

■ When using in DC mode

3 Setting Distributed Clock (DC) for the Slave

In the Project Explorer, select the target slave to display the Distributed Clock tab page.

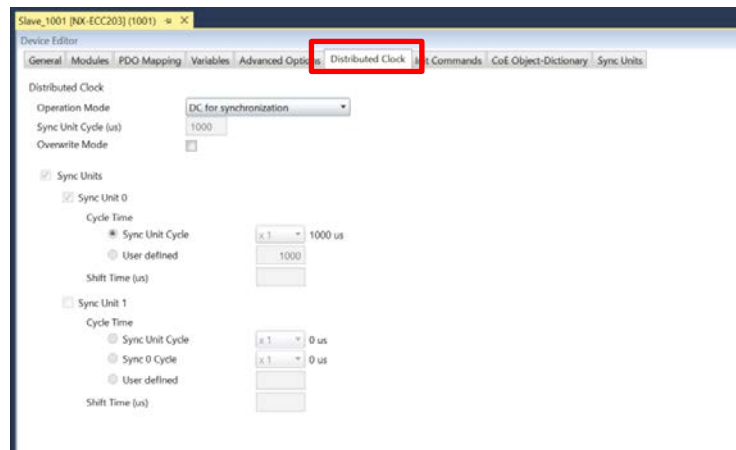
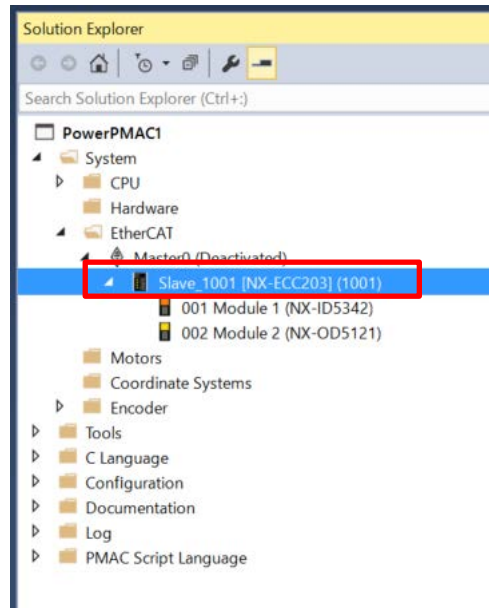

4 Select the **Overwrite Mode** check box and specify **Shift Time**.

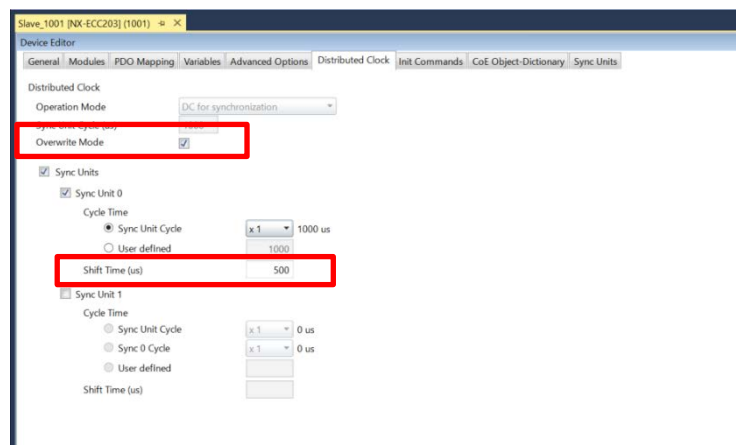

Correspondence between the servo frequencies of the Controller and **Shift Time** values is as follows:

4 kHz : 125 us

2 kHz : 250 us

1 kHz : 500 us

■ When using in Free-Run mode

3 Setting Distributed Clock (DC) for the Slave

In the Solution Explorer, select the target slave to display the Distributed Clock tab page.

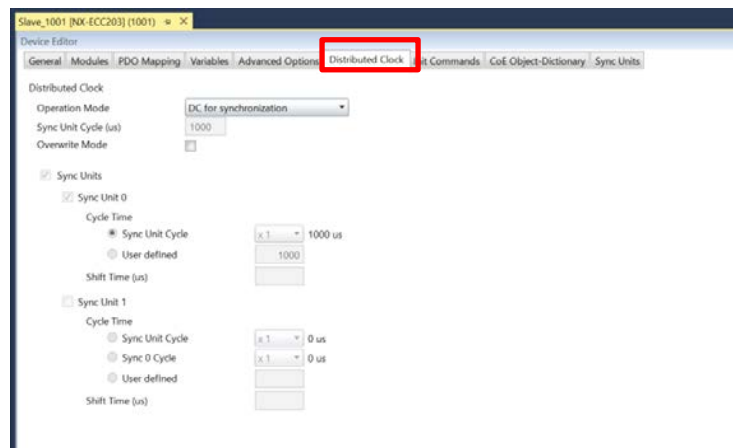
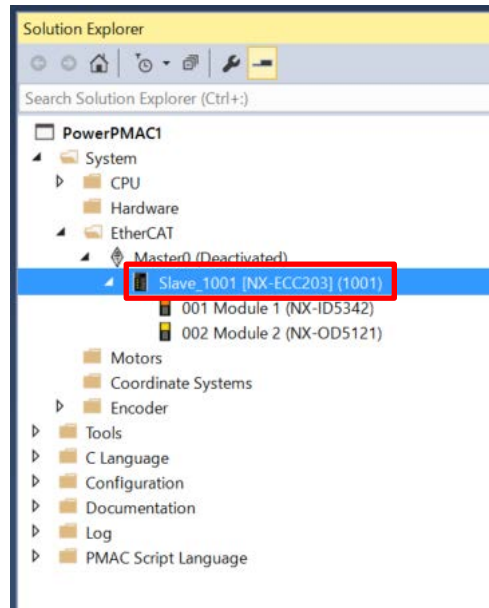

4 Select *FreeRun* from the drop down list for **Operation Mode**.

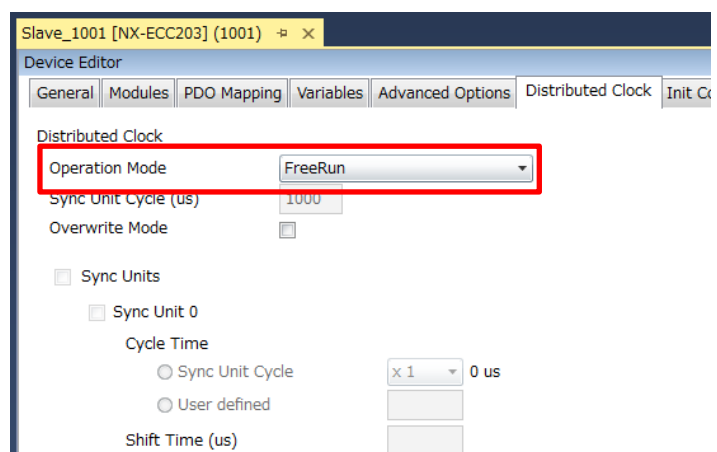

5 Display the Advanced Options tab page.

Clear the **Potential Reference Clock** check box.

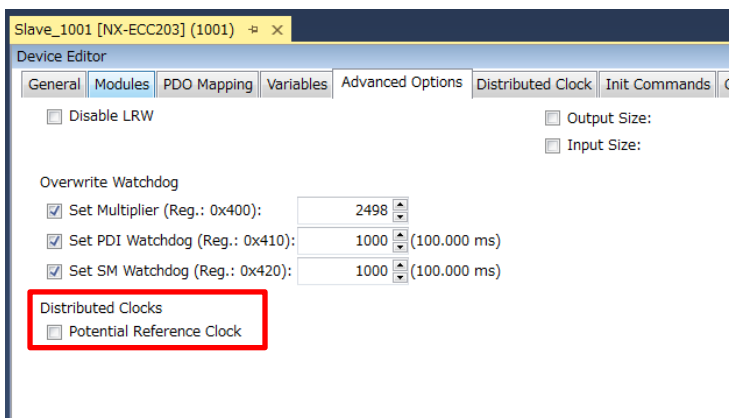

6.4.3. PDO Map Settings

- 1 In the Solution Explorer, select the target slave and display the PDO Mapping tab page.

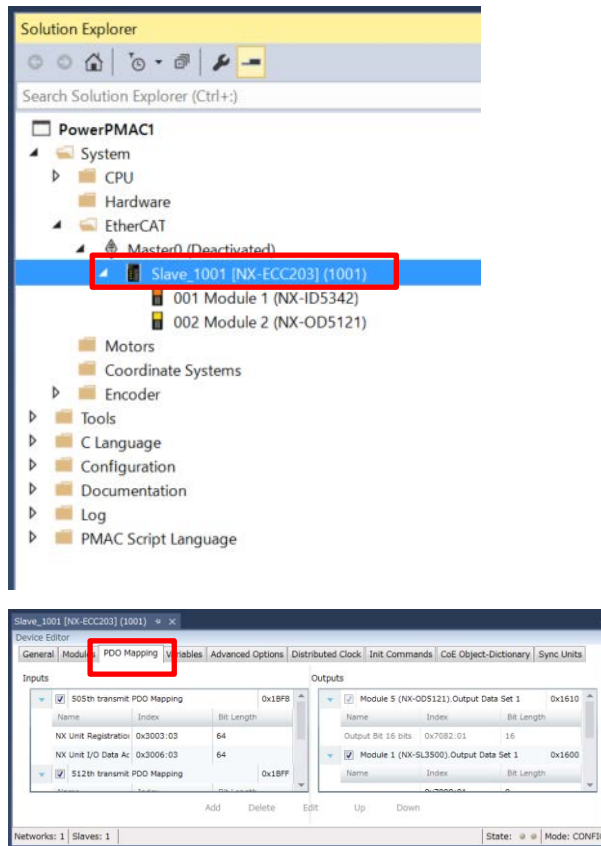

- 2 Setting PDO mapping (Inputs)

Confirm the check boxes in the Inputs field.

* If you do not want to use data in the Inputs field, clear the currently displayed check boxes.

Inputs			
<input checked="" type="checkbox"/>	505th transmit PDO Mapping		0x1BF8
	Name	Index	Bit Length
	NX Unit Registration Status 63	0x3003:03	64
	NX Unit I/O Data Active Status 63	0x3006:03	64
<input type="checkbox"/>	511th transmit PDO Mapping		0x1BFE
	Name	Index	Bit Length
	New Message Available	0x10F3:04	1
	---	0x0000:00	15
<input checked="" type="checkbox"/>	512th transmit PDO Mapping		0x1BFF
	Name	Index	Bit Length
	Sysmac Error Status	0x2002:01	8
<input checked="" type="checkbox"/>	501st transmit PDO Mapping		0x1BF4
	Name	Index	Bit Length
	---	0x0000:00	8
<input checked="" type="checkbox"/>	Module 1 (NX-ID5342).Input Data Set 1		0x1A00
	Name	Index	Bit Length
	Input Bit 16 bits	0x6002:01	16

- 3 Setting PDO mapping (Outputs)

Confirm the check boxes in the Outputs field.

* If you do not want to use data in the Outputs field, clear the currently displayed check boxes.

Outputs			
<input checked="" type="checkbox"/>	Module 2 (NX-OD5121).Output Data Set 1		0x1604
	Name	Index	Bit Length
	Output Bit 16 bits	0x7022:01	16

6.4.4. Creation of an EtherCAT Network Information File

- 1 Select **System – EtherCAT** in the Solution Explorer and right-click on **Master0 (Deactivated)**, then select **Load Mapping to PowerPMAC**.

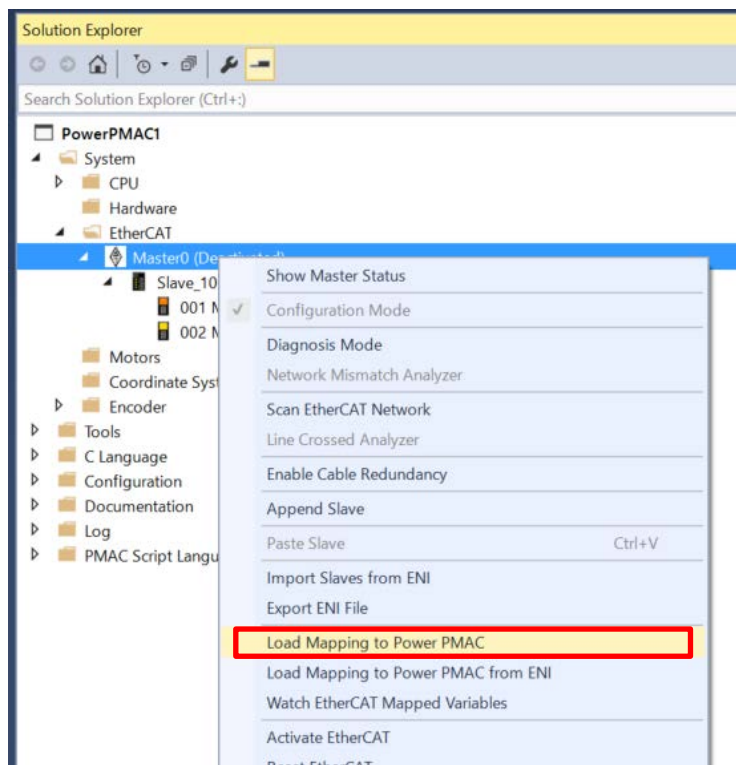

- 2 An eni.xml file is added under the **Configuration** directory in the Solution Explorer.

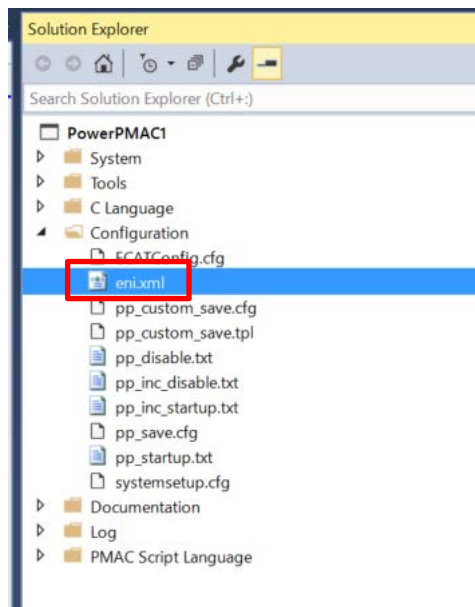

3 An ECATMap.pmh file is added under the **PMAC Script Language/Global Includes** directory in the Solution Explorer.

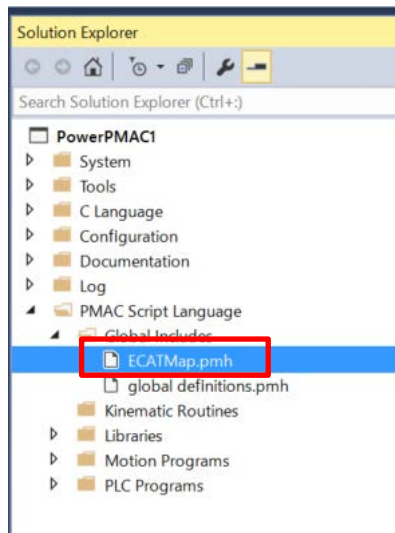

6.5. Controller Settings

6.5.1. EtherCAT Communications Check

Take the following steps to ensure that EtherCAT communications are available.

- 1** From the Terminal tab page, run the `ECAT[0].Enable=1` command to start EtherCAT communications.

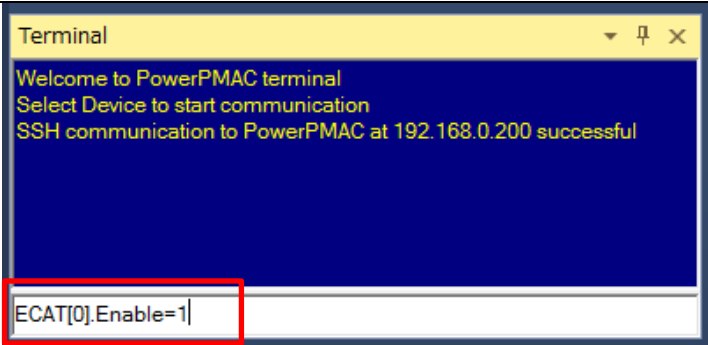

The screenshot shows a terminal window titled "Terminal" with a blue background. The text displayed is: "Welcome to PowerPMAC terminal", "Select Device to start communication", and "SSH communication to PowerPMAC at 192.168.0.200 successful". The command prompt shows `ECAT[0].Enable=1` being entered, which is highlighted with a red box.
- 2** In the Terminal tab page or Watch Window, make sure that the `ECAT[0].Enable` value turns to 1.

* The OP mode is entered and EtherCAT communications are established.

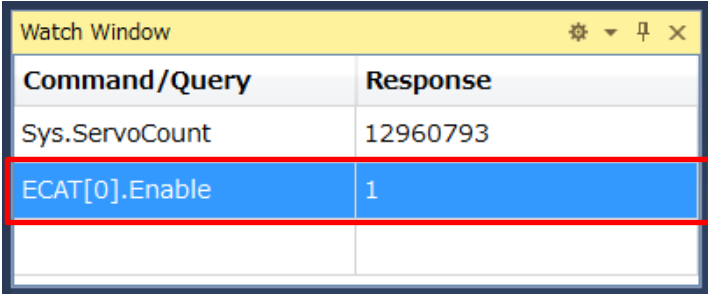

The screenshot shows a "Watch Window" with a table. The table has two columns: "Command/Query" and "Response". The first row shows "Sys.ServoCount" with a response of "12960793". The second row, highlighted with a red box, shows "ECAT[0].Enable" with a response of "1".

Command/Query	Response
Sys.ServoCount	12960793
ECAT[0].Enable	1
- 3** After making sure that correct communications are available, run the `ECAT[0].Enable=0` command from the Terminal tab page to stop EtherCAT communications.

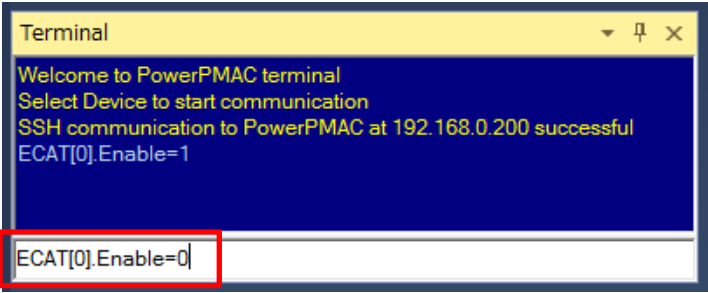

The screenshot shows a terminal window titled "Terminal" with a blue background. The text displayed is: "Welcome to PowerPMAC terminal", "Select Device to start communication", "SSH communication to PowerPMAC at 192.168.0.200 successful", and "ECAT[0].Enable=1". The command prompt shows `ECAT[0].Enable=0` being entered, which is highlighted with a red box.
- 4** In the Terminal tab page or Watch Window, make sure that the `ECAT[0].Enable` value turns to 0.

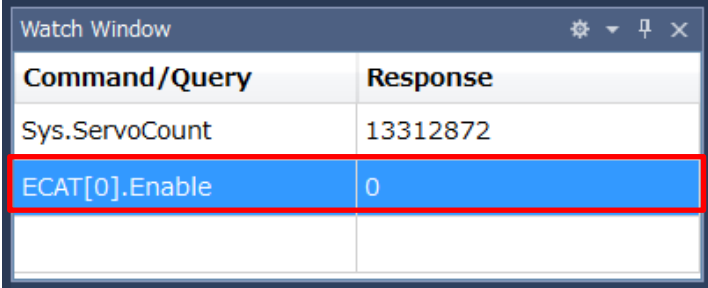

The screenshot shows a "Watch Window" with a table. The table has two columns: "Command/Query" and "Response". The first row shows "Sys.ServoCount" with a response of "13312872". The second row, highlighted with a red box, shows "ECAT[0].Enable" with a response of "0".

Command/Query	Response
Sys.ServoCount	13312872
ECAT[0].Enable	0

6.5.2. Writing the User Program

Create programs to be used to check operations.

A specific language is used for the operation check programs. Refer to *Power PMAC User's Manual* and *Power PMAC Software Reference Manual* for details.

- 1 In the Solution Explorer pane, open **Project name – PMAC Script Language – PLC Programs – plc1.plc**.

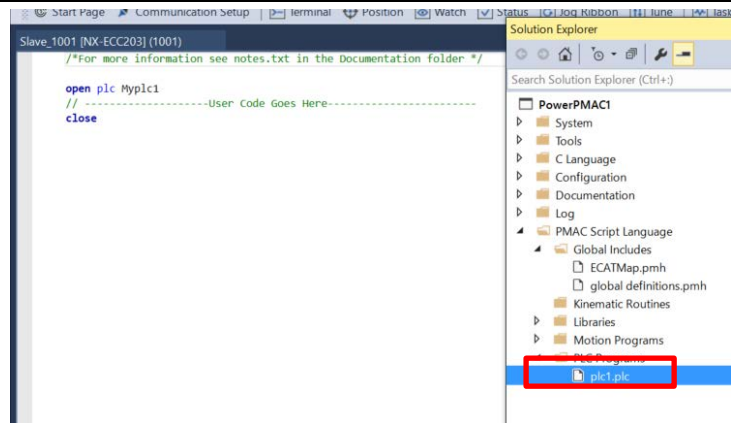

- 2 In the programming area of the plc1.plc tab page, write a program as show on the right.

This sample program blinks the NX-OD5121 output indicator every second.

* In this example, PDO mapping is assumed to be the default setting. If you want to change PDO mapping, rewrite the "Slave_0...." description.

open plc 1

```
while(sys.ecatMasterReady==0){};
```

```
ECAT[0].Enable=1;
```

```
P1000=Sys.Time+1;
while(P1000>Sys.Time){};
```

```
Slave_1001_NX_ECC203_1001_7020_1_OutputBit00 = 1;
```

```
P1000=Sys.Time+1;
while(P1000>Sys.Time){};
```

```
Slave_1001_NX_ECC203_1001_7020_1_OutputBit00 = 0;
```

close

- 3 Setting the start of the user program

In the Solution Explorer pane, open **Project name – Configuration – pp_disable.txt**.

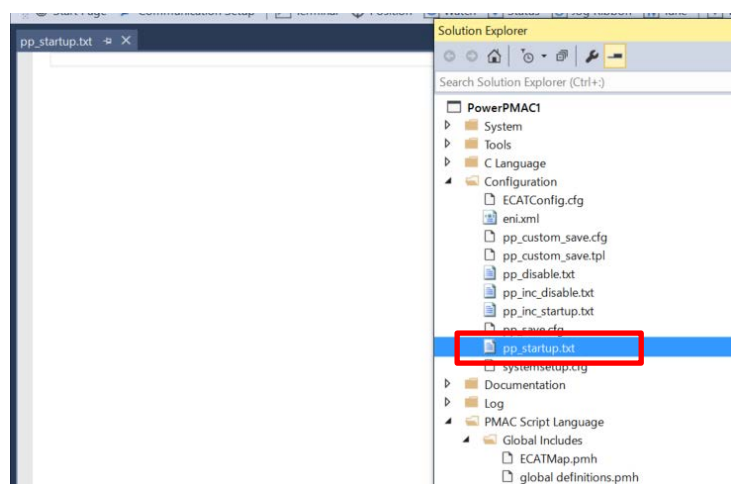

- 4** In the programming area of the pp_disable.txt tab page, add the program shown on the right to the last line.

```
enable plc 1;
```

The pp_disable.txt program is automatically executed when the Controller starts.

This example program runs the PLC1 script.

6.5.3. Project Data Transfer

Transfer the created project data to the Controller.

WARNING

When the user program and “configuration and setting” data are transferred from Power PMAC IDE, devices or the machine may perform unexpected operations. Therefore, before you transfer project data, ensure the destination slave is operating safely.



Caution

Transferring project data restarts the Controller and interrupts communications with slaves. The time that communications are interrupted depends on the EtherCAT network configuration. Before you transfer project data, make sure that the slave settings will not adversely affect the devices.



- 1** In the Terminal tab page or Watch Window, make sure that the ECAT[0].Enable value is 0.

If the value is 1, run the ECAT[0].Enable=0 command from the Terminal tab page to stop EtherCAT communications.

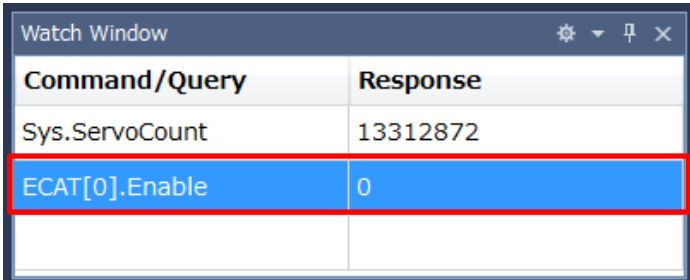

Command/Query	Response
Sys.ServoCount	13312872
ECAT[0].Enable	0

2 Downloading a project

Right-click the project name in the Solution Explorer pane on the upper right of the IDE screen, and select **Build and Download All Programs** to run the build and download.

* The transferred project is not yet saved to the Controller at this stage.

If you turn OFF the power to the Controller, the transferred project will be discarded.

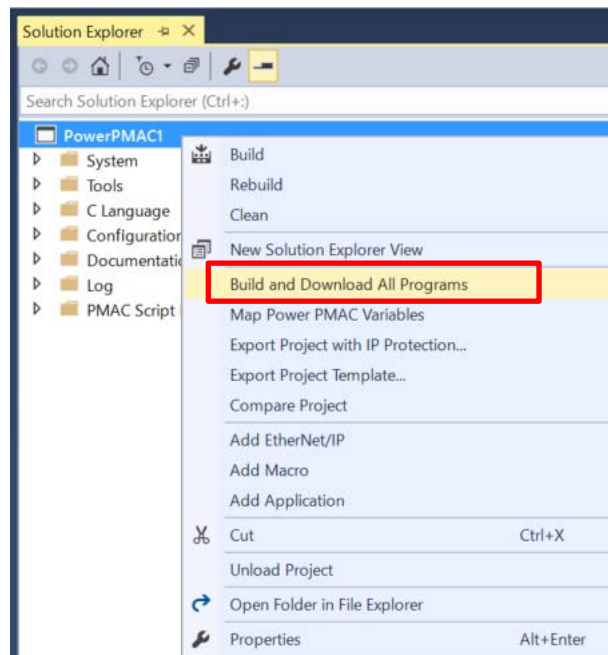

3 Make sure that there are no errors in the Output Window.

* If the transfer fails, check details of the error in the Output Window.

If the error is a program error, you must review the program.

If the error is related to EtherCAT settings, return to 6.4 EtherCAT Communications Setup and check whether there are any incorrect settings.

- 4** The program starts running when it has been downloaded successfully.

EtherCAT communications are in the OP state. Make sure that the NX-OD3256 output indicator blinks.

* If the indicator does not blink, check that the ECAT[0].Enable value is 1 in the Terminal tab page or Watch Window. If the value is 0, run the following command from the Terminal tab page.

enable plc 1

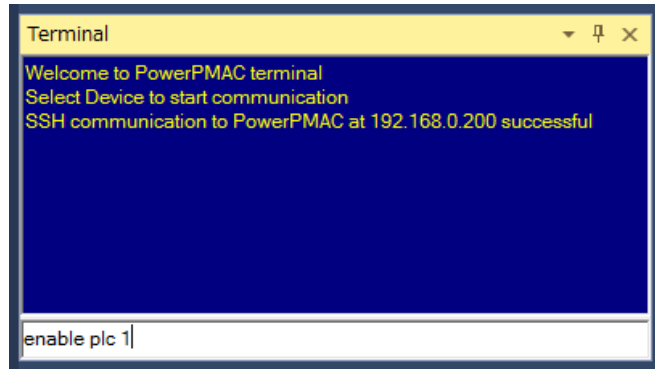

```
Terminal
Welcome to PowerPMAC terminal
Select Device to start communication
SSH communication to PowerPMAC at 192.168.0.200 successful

enable plc 1
```

- 5** After you have confirmed an appropriate operation, save the project to the Controller.

Run the save command from the Terminal tab page.

* The save command stores the downloaded project in the Controller. This operation saves the settings to be executed automatically when the power to the Controller is turned on.

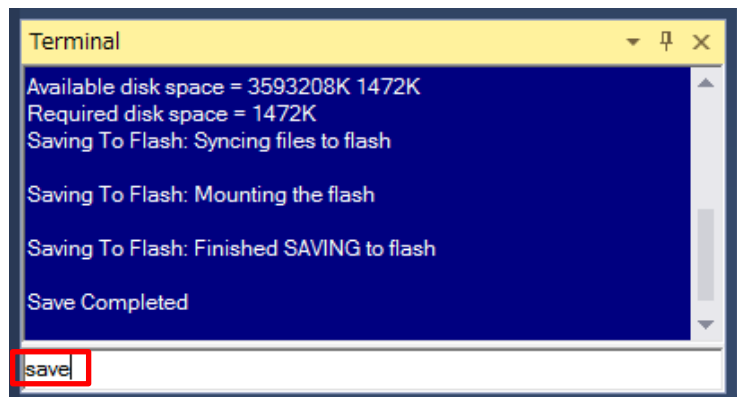

```
Terminal
Available disk space = 3593208K 1472K
Required disk space = 1472K
Saving To Flash: Syncing files to flash

Saving To Flash: Mounting the flash

Saving To Flash: Finished SAVING to flash

Save Completed

save
```

7. Appendix Saving and Loading a Project

The following describes the procedures to save a Power PMAC IDE project on the computer, and to reuse it.

7.1. Saving a Project

1 Creating a Configuration File

Create a Configuration File to save parameters you have changed.

Right-click **Configuration** in the Solution Explorer pane, and select **Generate Config File**. A Configuration File is added to **Configuration**.

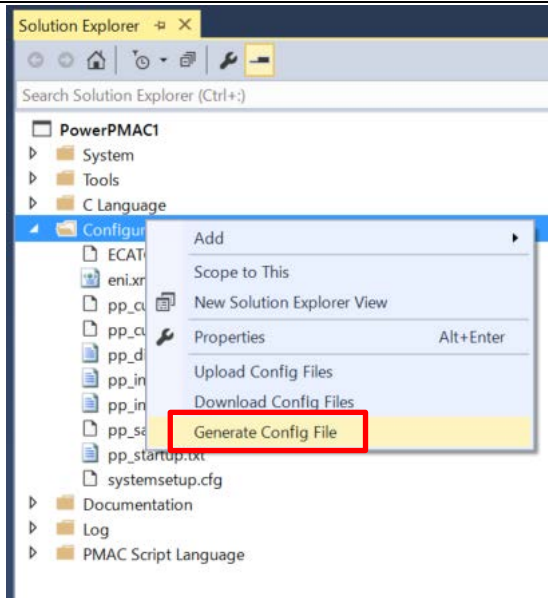

2 Enter a file name in the textbox, then click the OK button.

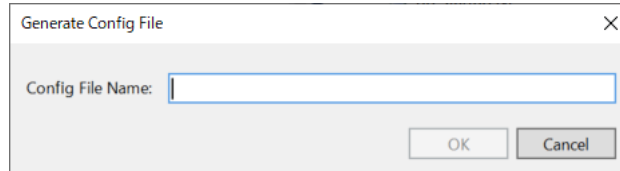

3 Right-click on the Configuration File, and from the menu, select **Check To Download Config File** to include it in files to be downloaded.

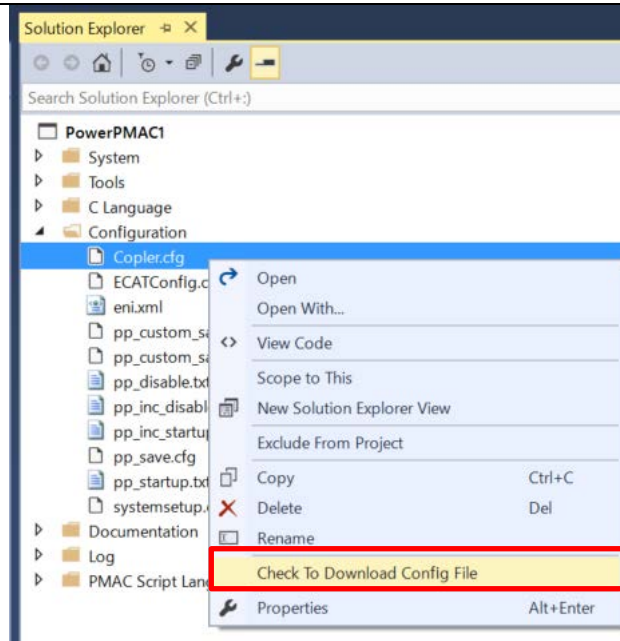

4 Saving a Project

In the **File** menu, run **Save All** to save the project on the computer.

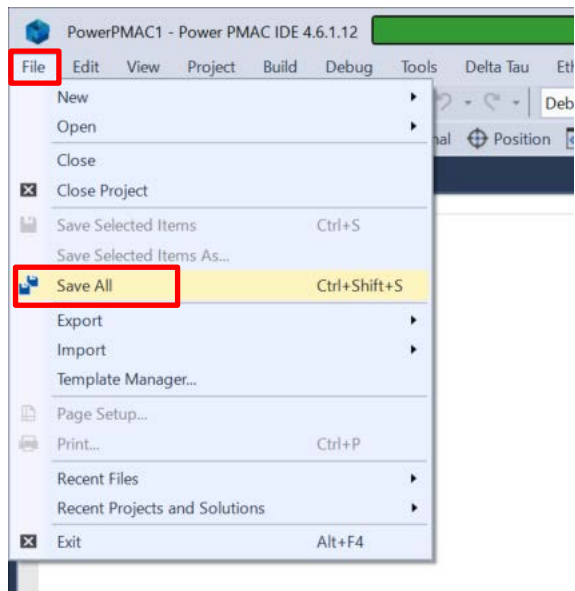

7.2. Loading and Downloading a Project

1 Start Power PMAC IDE, and connect to the Controller.

2 In the Terminal tab page, type the \$\$\$** command to reset the Controller settings to factory default.

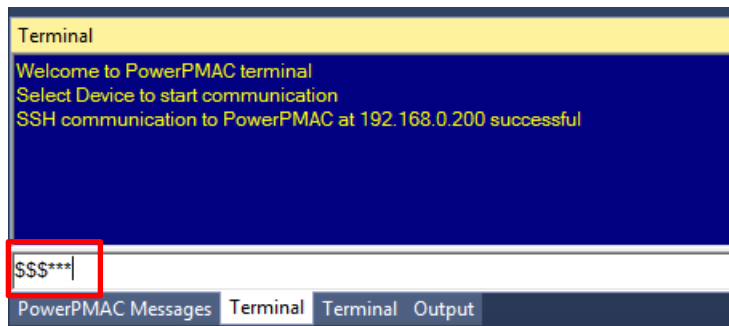

3 In the File menu, click **Open – Project/Solution** to load the project that you saved.

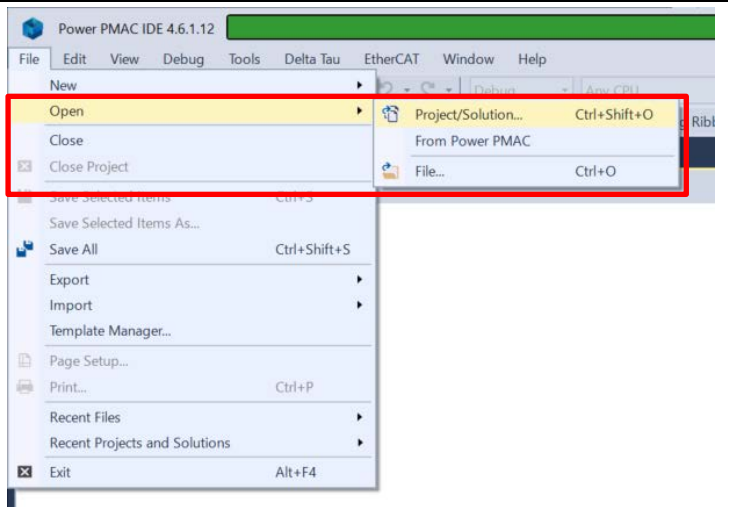

4 Right-click **Configuration** in the Solution Explorer pane, and select **Download Config Files** to download the file to the Controller.

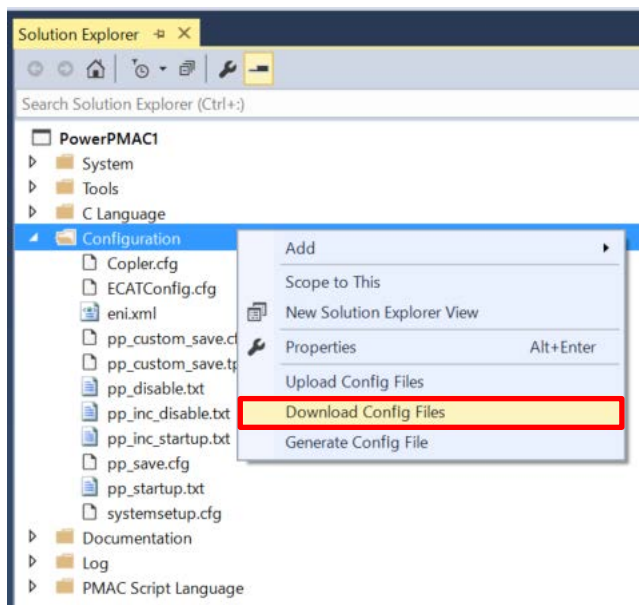

- 5** Right-click the project name in the Solution Explorer pane, and select **Build and Download All Programs** to run the build and download.

When the download process is complete, make sure that there are no errors in the Output tab Window.

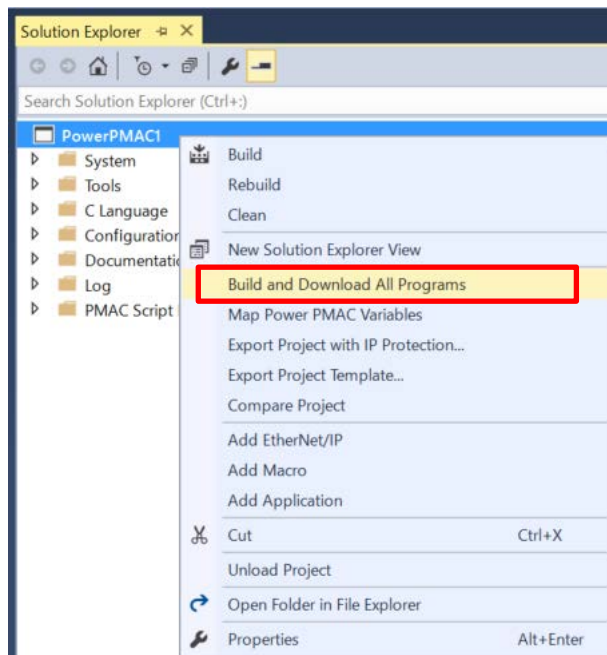

- 6** Stopping a program

If a program is running, execute the following command from the Terminal tab page to stop the program.

```
disable plc 1  
ECAT[0].Enable=0
```

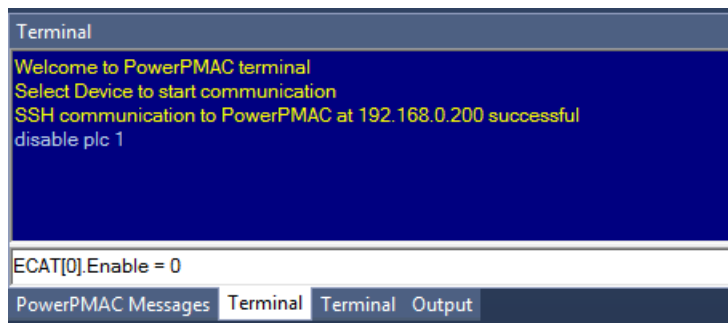
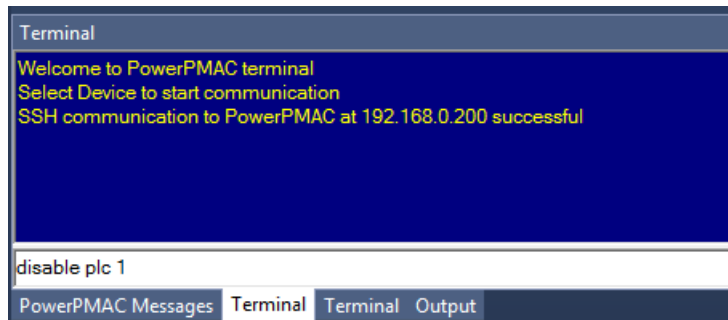

7 Saving the downloaded settings and programs

After the download process is complete and you make sure that there are no errors in the Output Window, run the save command from the Terminal tab page.

* The save command stores the downloaded project in the Controller. This operation saves the settings to be executed automatically when the power to the Controller is turned on.

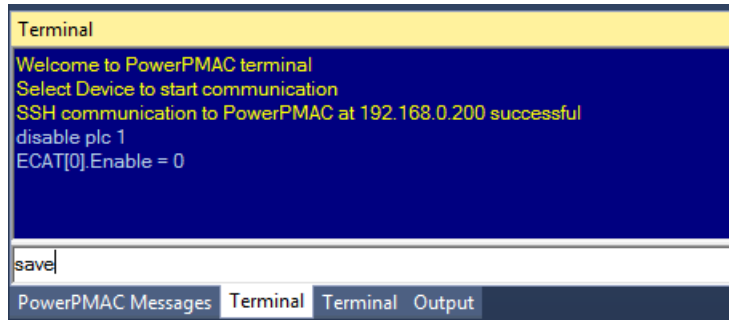

```
Terminal
Welcome to PowerPMAC terminal
Select Device to start communication
SSH communication to PowerPMAC at 192.168.0.200 successful
disable plc 1
ECAT[0].Enable = 0

save|
PowerPMAC Messages Terminal Terminal Output
```

8 Restarting after download

Run the following command from the Terminal tab page to restart the Controller with the downloaded project.
\$\$\$

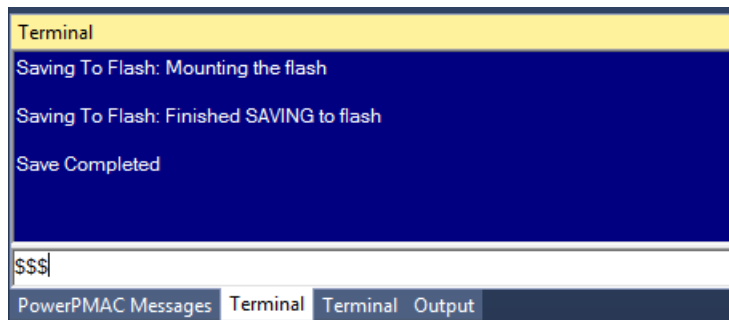

```
Terminal
Saving To Flash: Mounting the flash
Saving To Flash: Finished SAVING to flash
Save Completed

$$$|
PowerPMAC Messages Terminal Terminal Output
```

8. Appendix Troubleshooting

8.1. Factors Causing EtherCAT Communications To Be Unavailable, and Corrective Actions

Description	Factor	Corrective Action
The link is not established.	The Ethernet cable is broken or the specified cable is not being used.	If the Ethernet cable is broken or if the specified cable was not used, replace the cable.
	A connector on the Ethernet cable used for EtherCAT communications is disconnected, the contact is faulty, or parts are faulty.	Reconnect the connector and make sure it is mated correctly.
	A slave within the EtherCAT network configuration failed.	Replace the slave.
EtherCAT communications do not start.	ECAT[0].Enable is set to 0.	From the Terminal pane, run the ECAT[0].Enable=1 command to start EtherCAT communications.
	The EtherCAT network configuration in the Controller does not agree with the physical network configuration.	Review the settings according to the procedures provided in <i>6.4 EtherCAT Communications Setup</i> .
	The Ethernet cable is broken at a slave in the network, or a connector is disconnected.	Connect the Ethernet cable correctly.
	Some errors have occurred, and the ECAT[0].error is set to a value other than 0.	Check the ECAT[0].error value.
A synchronization error occurs at a slave.	The distribution clock is not set correctly.	Review the settings according to the procedures provided in <i>6.4.2 Distributed Clock Setup</i> .
	A slave in Free-Run Mode is set to the reference clock.	
	The servo task processing time exceeds the set period.	Review the program or servo frequency to adjust it, so that the servo task processing time does not exceed the period.

8.2. How to Check for Errors

8.2.1. Checking the EtherCAT Status

You can check the EtherCAT status from **Diagnosis Mode** of Power PMAC IDE.

Right-click on **Master0 (Deactivated)** under **EtherCAT** in the Solution Explorer, then select **Diagnosis Mode** to open the Diagnosis Mode page

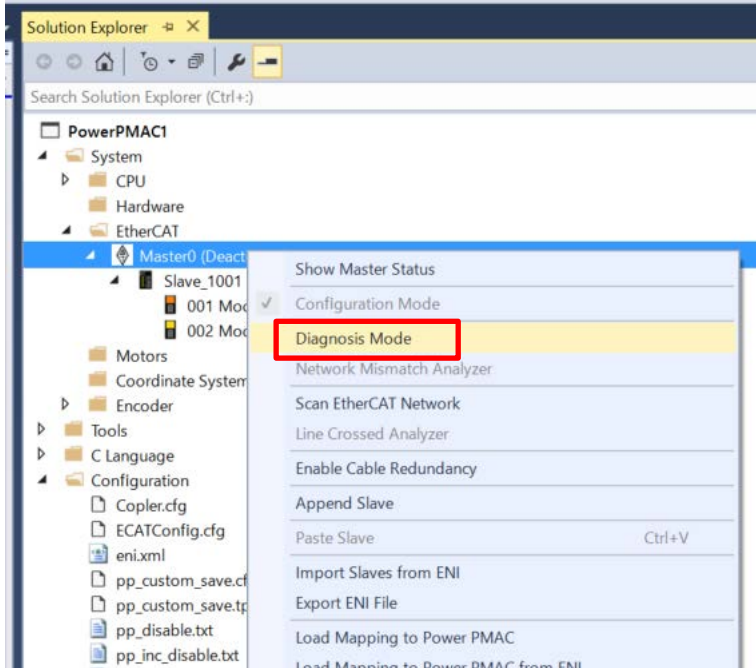

You can check the status of the slaves in the Diagnosis Mode page.

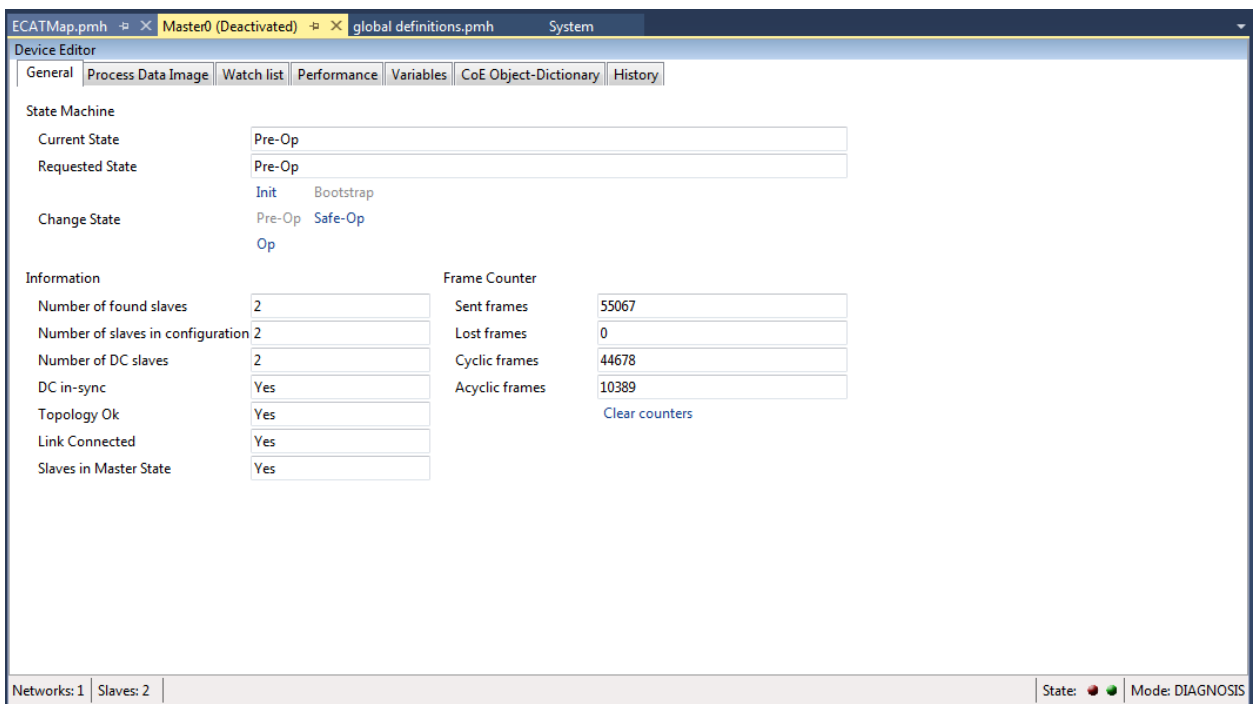

8.2.2. Checking the Controller Status

In the Status page of Power PMAC IDE, you can check the status of the motor, coordinate system, and system.

To display the Status page, click **Status** on the toolbar.

■ Global Status

You can check system errors such as the WDT error.

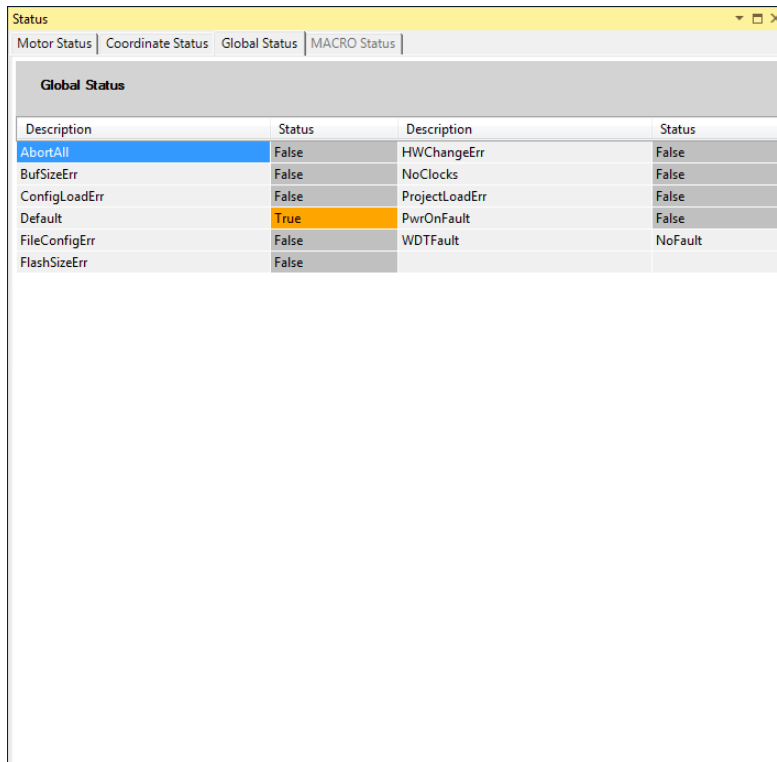

The screenshot shows a window titled "Status" with a yellow header bar. Below the header are four tabs: "Motor Status", "Coordinate Status", "Global Status", and "MACRO Status". The "Global Status" tab is selected. Below the tabs is a table with the following data:

Description	Status	Description	Status
AbortAll	False	HWChangeErr	False
BufSizeErr	False	NoClocks	False
ConfigLoadErr	False	ProjectLoadErr	False
Default	True	PwrOnFault	False
FileConfigErr	False	WDTFault	NoFault
FlashSizeErr	False		

■ Motor Status

You can check deviation errors, limit errors, and other states of the motor.

Description	Status	Description	Status
AmpEna	False	I2tFault	False
AmpFault	False	InPos	False
AmpWarn	False	InterlockStop	False
AuxFault	False	LimitStop	False
BIDir	Plus	MinusLimit	False
BlockRequest	False	PhaseFound	False
ClosedLoop	False	PlusLimit	False
Csolve	False	SoftLimit	False
DacLimit	False	SoftLimitDir	Plus
DesVelZero	True	SoftMinusLimit	False
EnclLoss	False	SoftPlusLimit	False
FeFatal	False	SpindleMotor	False
FeWarn	False	TraceCount	0
GantryHomed	False	TriggerMove	False
HomeComplete	False	TriggerNotFound	False
HomeInProgress	False	TriggerSpeedSel	MaxSpeed

■ Coordinate Status

You can check deviation errors, limit errors and other states of the coordinate system.

Description	Status	Description	Status
AddedDwellDis	True	LinToPvtBuf	False
AmpEna	False	LookAheadActive	False
AmpFault	False	LookAheadChange	False
AmpWarn	False	LookAheadDir	Forward
AuxFault	False	LookAheadFlush	False
BlockActive	False	LookAheadLookBack	False
BlockRequest	False	LookAheadReCalc	False
BufferWarn	0	LookAheadStop	False
CC3Active	False	LookAheadWrap	False
CCAddedArc	False	MinusLimit	False
CCMode	Off	MoveMode	LineCircle
CCMoveType	Dwell	PlusLimit	False
CCOffReq	False	ProgActive	False
ClosedLoop	False	ProgProceeding	False
ContMotion	False	ProgRunning	False
Csolve	False	SegEnabled	False
DesVelZero	False	SegHaltReq	False
EnclLoss	False	SegMove	Off
EndDelayActive	False	SegMoveAccel	False
ErrorStatus	NoError	SegMoveDecel	False
FeedHold	Off	SegStopReq	False
FeFatal	False	SharpCornerStop	False
FeWarn	False	SoftMinusLimit	False
HomeComplete	False	SoftPlusLimit	False
HomeInProgress	False	TimerEnabled	False
I2tFault	False	TimersEnabled	False
InPos	False	TriggerMove	False
InterlockStop	False	TriggerNotFound	False

9. Appendix ECAT[i] Structure Elements

The Controller uses motion controller technology developed by Delta Tau Data Systems, Inc., (hereafter referred to as DT) in the U.S., however, the ECAT[i] structure elements differ from those of DT controllers. The following table shows the major changes that have been made from DT controllers.

Element name	Description	Change
ECAT[i].Enable	Enabling the EtherCAT network	0: Disable, 1: Enable (2 and 3 are not supported.)
ECAT[i].LPIO[k]	Elements of low priority I/O module	Not supported
ECAT[i].Slave[j]	Slave elements	Not supported
ECAT[i].Error	Error code of enabling EtherCAT network	\$ 9811000C: Invalid network configuration \$ 9811002E: Disconnected network connection
ECAT[i].LinkUp ECAT[i].LPDomainOutputState ECAT[i].LPDomainState ECAT[i].LPRxTime ECAT[i].LPTxTime ECAT[i].MasterStat ECAT[i].RTDomainOutputState ECAT[i].RTDomainState	Status data structure elements	Not supported

10. Revision History

Revision code	Revised date	Revised content
01	Apr, 2019	First edition
02	Jan,2023	<ul style="list-style-type: none">• Made changes accompanying the addition of CK5M-CPU1 □1 Unit.• Made changes accompanying the modification of GUI of PowerPMAC IDE.

OMRON Corporation Industrial Automation Company

Kyoto, JAPAN

Contact : www.ia.omron.com

Regional Headquarters

OMRON EUROPE B.V.

Wegalaan 67-69, 2132 JD Hoofddorp
The Netherlands

Tel: (31) 2356-81-300 Fax: (31) 2356-81-388

OMRON ASIA PACIFIC PTE. LTD.

438B Alexandra Road, #08-01/02 Alexandra
Technopark, Singapore 119968

Tel: (65) 6835-3011 Fax: (65) 6835-2711

OMRON ELECTRONICS LLC

2895 Greenspoint Parkway, Suite 200
Hoffman Estates, IL 60169 U.S.A.

Tel: (1) 847-843-7900 Fax: (1) 847-843-7787

OMRON (CHINA) CO., LTD.

Room 2211, Bank of China Tower,
200 Yin Cheng Zhong Road,
PuDong New Area, Shanghai, 200120, China

Tel: (86) 21-5037-2222 Fax: (86) 21-5037-2200

Authorized Distributor:

©OMRON Corporation 2019 - 2023 All Rights Reserved.
In the interest of product improvement,
specifications are subject to change without notice.

Cat. No. 0041-E1-02 0123