

AC Servo System 1S-series with safety functionality

Startup Guide

R88M-1AL[]/-1AM[] (AC Servomotors)

R88D-1SAN[]-ECT (AC Servo Drives)

Startup
Guide



NOTE

All rights reserved. No part of this publication may be reproduced, stored in a retrieval system, or transmitted, in any form, or by any means, mechanical, photocopying, recording, or otherwise, without the prior written permission of OMRON.

No patent liability is assumed with respect to the use of the information contained herein. Moreover, because OMRON is constantly striving to improve its high-quality products, the information contained in this manual is subject to change without notice. Every precaution has been taken in the preparation of this manual. Nevertheless, OMRON assumes no responsibility for errors or omissions. Neither is any liability assumed for damages resulting from the use of the information contained in this publication.

Introduction

The *AC Servo System 1S-Series with Built-in EtherCAT Communications and Safety Functionality Startup Guide* (hereinafter, may be referred to as "this Guide") describes the procedures for installation and setup of a 1S-series Servo Drive with Built-in EtherCAT Communications and Safety Functionality (hereinafter referred to as "1S-series Servo Drive Advance Type"), where an NJ/NX-series CPU Unit is used in combination with 1S-series AC Servomotors/Servo Drives Advance Type and NX-series Safety Control Unit, by using the Sysmac Studio. A simple installation model is used for the discussion. You can perform the procedures that are presented in this Guide to quickly gain a basic understanding of a 1S-series AC Servomotors/Servo Drives Advance Type.

The safety circuits described in this Guide are not safety certified. The described usage examples of safety components and safety circuits may differ from your usage. This Guide does not contain safety information and other details that are required for actual use.

Thoroughly read and understand the manuals for all of the devices that are used in this Guide to ensure that the system is used safely. Review the entire contents of these materials, including all safety precautions, precautions for safe use, and precautions for correct use.

Intended Audience

This Guide is intended for the following personnel.

- Personnel in charge of introducing FA systems
- Personnel in charge of designing FA systems

The personnel must also have the following knowledge.

- Knowledge of electrical systems (an electrical engineer or the equivalent)
- Knowledge of NJ/NX-series CPU Units
- Knowledge of NX-series Safety Units
- Knowledge of AC Servomotors/Drives
- Knowledge of operation procedure of Sysmac Studio

Applicable Products

This Guide covers the following products.

- Machine Automation Controller NJ/NX-series CPU Unit
- Automation Software Sysmac Studio
- 1S-series Servomotor/Servo Drive Advance Type
- NX-series EtherCAT Coupler Unit
- NX-series Safety Control Unit

Special Information

Special information in this Guide is classified as follows:



Precautions for Correct Use

Precautions on what to do and what not to do to ensure safe usage of the product.



Additional Information

Additional information to read as required.

This information is provided to increase understanding or make operation easier.

Terms and Conditions Agreement

Warranties

(a) Exclusive Warranty. Omron's exclusive warranty is that the Products will be free from defects in materials and workmanship for a period of twelve months from the date of sale by Omron (or such other period expressed in writing by Omron). Omron disclaims all other warranties, express or implied.

(b) Limitations. OMRON MAKES NO WARRANTY OR REPRESENTATION, EXPRESS OR IMPLIED, ABOUT NON-INFRINGEMENT, MERCHANTABILITY OR FITNESS FOR A PARTICULAR PURPOSE OF THE PRODUCTS. BUYER ACKNOWLEDGES THAT IT ALONE HAS DETERMINED THAT THE PRODUCTS WILL SUITABLY MEET THE REQUIREMENTS OF THEIR INTENDED USE.

Omron further disclaims all warranties and responsibility of any type for claims or expenses based on infringement by the Products or otherwise of any intellectual property right. (c) Buyer Remedy.

Omron's sole obligation hereunder shall be, at Omron's election, to (i) replace (in the form originally shipped with Buyer responsible for labor charges for removal or replacement thereof) the non-complying Product, (ii) repair the non-complying Product, or (iii) repay or credit Buyer an amount equal to the purchase price of the non-complying Product; provided that in no event shall Omron be responsible for warranty, repair, indemnity or any other claims or expenses regarding the Products unless Omron's analysis confirms that the Products were properly handled, stored, installed and maintained and not subject to contamination, abuse, misuse or inappropriate modification. Return of any Products by Buyer must be approved in writing by Omron before shipment. Omron Companies shall not be liable for the suitability or unsuitability or the results from the use of Products in combination with any electrical or electronic components, circuits, system assemblies or any other materials or substances or environments. Any advice, recommendations or information given orally or in writing, are not to be construed as an amendment or addition to the above warranty.

See <http://www.omron.com/global/> or contact your Omron representative for published information.

Limitation on Liability; Etc

OMRON COMPANIES SHALL NOT BE LIABLE FOR SPECIAL, INDIRECT, INCIDENTAL, OR CONSEQUENTIAL DAMAGES, LOSS OF PROFITS OR PRODUCTION OR COMMERCIAL LOSS IN ANY WAY CONNECTED WITH THE PRODUCTS, WHETHER SUCH CLAIM IS BASED IN CONTRACT, WARRANTY, NEGLIGENCE OR STRICT LIABILITY.

Further, in no event shall liability of Omron Companies exceed the individual price of the Product on which liability is asserted.

Suitability of Use

Omron Companies shall not be responsible for conformity with any standards, codes or regulations which apply to the combination of the Product in the Buyer's application or use of the Product. At Buyer's request, Omron will provide applicable third party certification documents identifying ratings and limitations of use which apply to the Product. This

information by itself is not sufficient for a complete determination of the suitability of the Product in combination with the end product, machine, system, or other application or use. Buyer shall be solely responsible for determining appropriateness of the particular Product with respect to Buyer's application, product or system. Buyer shall take application responsibility in all cases.

NEVER USE THE PRODUCT FOR AN APPLICATION INVOLVING SERIOUS RISK TO LIFE OR PROPERTY WITHOUT ENSURING THAT THE SYSTEM AS A WHOLE HAS BEEN DESIGNED TO ADDRESS THE RISKS, AND THAT THE OMRON PRODUCT(S) IS PROPERLY RATED AND INSTALLED FOR THE INTENDED USE WITHIN THE OVERALL EQUIPMENT OR SYSTEM.

Programmable Products

Omron Companies shall not be responsible for the user's programming of a programmable Product, or any consequence thereof.

Performance Data

Data presented in Omron Company websites, catalogs and other materials is provided as a guide for the user in determining suitability and does not constitute a warranty. It may represent the result of Omron's test conditions, and the user must correlate it to actual application requirements. Actual performance is subject to the Omron's Warranty and Limitations of Liability

Change in Specifications

Product specifications and accessories may be changed at any time based on improvements and other reasons. It is our practice to change part numbers when published ratings or features are changed, or when significant construction changes are made. However, some specifications of the Product may be changed without any notice. When in doubt, special part numbers may be assigned to fix or establish key specifications for your application. Please consult with your Omron's representative at any time to confirm actual specifications of purchased Product.

Errors and Omissions

Information presented by Omron Companies has been checked and is believed to be accurate; however, no responsibility is assumed for clerical, typographical or proofreading errors or omissions.

Precautions

- When building a system, check the specifications for all devices and equipment that will make up the system and make sure that the OMRON products are used well within their rated specifications and performances. Safety measures, such as safety circuits, must be implemented in order to minimize the risks in the event of a malfunction.
- Thoroughly read and understand the manuals for all devices and equipment that will make up the system to ensure that the system is used safely. Review the entire contents of these manuals, including all safety precautions, precautions for safe use, and precautions for correct use.
- Confirm all regulations, standards, and restrictions that the system must adhere to.
- Check the user program for proper execution before you use it for actual operation.

Trademarks

- Sysmac and SYSMAC are trademarks or registered trademarks of OMRON Corporation in Japan and other countries for OMRON factory automation products.
- Windows is either registered trademarks or trademarks of Microsoft Corporation in the USA and other countries.
- EtherCAT® is registered trademark and patented technology, licensed by Beckhoff Automation GmbH, Germany.
- Microsoft product screen shot(s) reprinted with permission from Microsoft Corporation.
- Other company names and product names in this Guide are the trademarks or registered trademarks of their respective companies.

Software Licenses and Copyrights

The NJ-series CPU Units and Sysmac Studio incorporate certain third party software. The license and copyright information associated with this software is available at http://www.fa.omron.co.jp/nj_info_e/.

Related Manuals

The following manuals are related. Use these manuals for reference.

Manual name	Cat. No.	Model	Application	Description
1S-Series AC Servomotors/Servo Drives with Built-in EtherCAT Communications and Safety Functionality User's Manual	I621	R88D-1SAN-ECT R88M-1A□	Learning detailed specifications of a 1S-series Servo Drive Advance Type.	Describes how to install and wire the Servo Drive, set parameters needed to operate the Servo Drive, and remedies to be taken and inspection methods to be used in case that problem occur.
Sysmac Studio Version 1 Operation Manual	W504	SYSMAC-SE2□□□	Learning about the operating procedures and functions of the Sysmac Studio.	Describes the operating procedures of the Sysmac Studio.
Sysmac Studio Drive Functions Operation Manual	I589	SYSMAC-SE2□□□	Learning how to set up and adjust the Servo Drives.	Describes the operating procedures of the Sysmac Studio.
NX-series CPU Unit Hardware User's Manual	W535	NX701-□□□□	Learning the basic specifications of the NX-series CPU Units, including introductory information, designing, installation, and maintenance. Mainly hardware information is provided.	Provides an introduction to the entire NX-series system along with the following information on the CPU Unit. <ul style="list-style-type: none"> • Features and system configuration • Introduction • Part names and functions • General specifications • Installation and wiring • Maintenance and inspection
NX-series NX102 CPU unit Hardware User's Manual	W593	NX102-□□□□	Learning the basic specifications of the NX102 CPU Units, including introductory information, designing, installation, and maintenance. Mainly hardware information is provided.	Provides an introduction to the entire NX102 system along with the following information on the CPU Unit. <ul style="list-style-type: none"> • Features and system configuration • Introduction • Part names and functions • General specifications • Installation and wiring • Maintenance and inspection
NX-series NX1P2 CPU unit Hardware User's Manual	W578	NX1P2-□□□□	Learning the basic specifications of the NX1P2 CPU Units, including introductory information, designing, installation, and maintenance. Mainly hardware information is provided.	Provides an introduction to the entire NX1P2 system along with the following information on the CPU Unit. <ul style="list-style-type: none"> • Features and system configuration • Introduction • Part names and functions • General specifications • Installation and wiring • Maintenance and inspection

Manual name	Cat. No.	Model	Application	Description
NJ-series CPU Unit Hardware User's Manual	W500	NJ501-□□□□ NJ301-□□□□ NJ101-□□□□	Learning the basic specifications of the NJ-series CPU Units, including introductory information, designing, installation, and maintenance. Mainly hardware information is provided.	Provides an introduction to the entire NJ-series system along with the following information on the CPU Unit. <ul style="list-style-type: none"> • Features and system configuration • Introduction • Part names and functions • General specifications • Installation and wiring • Maintenance and inspection
NJ/NX-series CPU Unit Software User's Manual	W501	NX701-□□□□ NX102-□□□□ NX1P2-□□□□ NJ501-□□□□ NJ301-□□□□ NJ101-□□□□	Learning how to program and set up an NJ/NX-series CPU Unit. Mainly software information is provided.	Provides the following information on a Controller built with an NJ/NX-series CPU Unit. <ul style="list-style-type: none"> • CPU Unit operation • CPU Unit features • Initial settings • Language specifications and programming based on IEC 61131-3
NJ/NX-series CPU Unit Motion Control User's Manual	W507	NX701-□□□□ NX102-□□□□ NX1P2-□□□□ NJ501-□□□□ NJ301-□□□□ NJ101-□□□□	Learning about motion control settings and programming concepts.	Describes the settings and operation of the CPU Unit and programming concepts for motion control.
NJ/NX-series Instructions Reference Manual	W502	NX701-□□□□ NX102-□□□□ NX1P2-□□□□ NJ501-□□□□ NJ301-□□□□ NJ101-□□□□	Learning detailed specifications on the basic instructions of an NJ/ NX CPU Unit.	Describes the instructions in the instruction set (IEC 61131-3 specifications).
NJ/NX-series Motion Control Instructions Reference Manual	W508	NX701-□□□□ NX102-□□□□ NX1P2-□□□□ NJ501-□□□□ NJ301-□□□□ NJ101-□□□□	Learning about the specifications of the motion control instructions that are provided by OMRON.	Describes the motion control instructions.
NJ/NX-series Troubleshooting Manual	W503	NX701-□□□□ NX102-□□□□ NX1P2-□□□□ NJ501-□□□□ NJ301-□□□□ NJ101-□□□□	Learning about the errors that may be detected in an NJ/NX-series Controller.	Describes concepts on managing errors that may be detected in an NJ/NX-series Controller and information on individual errors.
NX-series Safety Control Units User's Manual	Z930	NX-SL□□□□ NX-SI□□□□ NX-SO□□□□	Learning how to use the NX-series Safety Control Units.	Describes the hardware, setup methods and functions of the NX-series Safety Control Units.

Revision History

A manual revision code appears as a suffix to the catalog number on the front and back covers of the manual.

Cat. No.	I859-E1-03
-----------------	-------------------

 Revision code

Revision code	Date	Revised content
01	December 2020	Original production
02	March 2021	Added safety functions (Sections 4.1, 4.2, 4.4, 4.6, and 4.7 added)
03	June 2021	<ul style="list-style-type: none"> • Added recovery procedure for SLP function. • Added Section 4.8. • Corrected mistakes.

CONTENTS

Introduction	3
Intended Audience	3
Applicable Products	3
Special Information	4
Terms and Conditions Agreement	5
Precautions	7
Trademarks	7
Software Licenses and Copyrights.....	7
Related Manuals	8
Revision History	10
1. Servo System Configuration and Peripheral Products	12
1.1. Outline	12
1.2. Servo System Constructed in This Guide	13
1.3. System Configuration.....	14
2. Before You Begin	16
3. Performing Setup	17
3.1. Installation and Wiring.....	19
3.2. System Configuration with Standard and Safety Controllers	28
3.3. Sysmac Studio Project Creation	29
3.4. Motor, ABS Encoder and I/O Setup	49
3.5. Easy Tuning for Gain Adjustment.....	53
3.6. Creating a Motor Control Program.....	57
4. Adding a Safety Function	61
4.1. Adding the Safe Brake Control (SBC) Function to the STO Function	61
4.2. Adding the Safe Stop 1 (SS1) Function	74
4.3. Adding the Safe Stop 2 (SS2) Function	88
4.4. Adding the Safe Operating Stop (SOS) Function.....	101
4.5. Adding the Safely-limited Speed (SLS) Function	112
4.6. Adding the Safely-limited Position (SLP) Function.....	124
4.7. Adding the Safe Direction (SDI) Function	141
4.8. Adding Multiple Safety Functions (SS2 + SLS).....	152
Appendices	166
Adding a Servo Drive and Axis from Motor Sizing Tool Results	166
Test Run and Data Trace	167
Manual Tuning	169
Advanced Tuning	173

1. Servo System Configuration and Peripheral Products

1.1. Outline

The 1S-series Servo Drives Advance Type support 100-Mbps EtherCAT.

When you use the 1S-series Servo Drive Advance Type with a Machine Automation Controller NJ/NX-series CPU Unit or CJ1W-NC□8□ Position Control Unit with EtherCAT interface, you can construct a high-speed and sophisticated positioning control system.

You need only one communications cable to connect the Servo Drive and the Controller. Therefore, you can realize a position control system easily with reduced wiring effort.

With tuning functions, adaptive notch filter, notch filter, and damping control, you can set up a system that provides stable operation by suppressing vibration in low-rigidity machines.

The 1S-series Servo Drives Advance Type support the FSoE (Safety over EtherCAT) protocol as the safety communications. You can build the safety system that uses safety functions from the safety CPU unit on the EtherCAT network.



Additional Information

For further details on the 1S-series Servo Drives Advance Type, refer to the *1S-Series AC Servomotors/Servo Drives with Built-in EtherCAT Communications and Safety Functionality User's Manual* (Cat. No. I621).

1.2. Servo System Constructed in This Guide

This Guide contains instructions from assembling the hardware that makes up a servo system to constructing a system for safety functions and performing debugging on the system. The servo system is built through the following steps:

■ Performing Setup

1 Installation and Wiring



2 System Configuration with Standard and Safety Controllers



3 Sysmac Studio Project Creation



4 Motor, ABS Encoder and I/O Setup



5 Easy Tuning for Gain Adjustment



6 Creating a Motor Control Program



■ Adding a Safety Function

1 Select a safety function from below and add it.

- Adding the Safe Brake Control (SBC) Function to the STO Function
- Adding the Safe Stop 1 (SS1) Function
- Adding the Safe Stop 2 (SS2) Function
- Adding the Safe Operating Stop (SOS) Function
- Adding the Safely-limited Speed (SLS) Function
- Adding the Safely-limited Position (SLP) Function
- Adding the Safe Direction (SDI) Function
- Adding Multiple Safety Functions (SS2 + SLS)



Additional Information

For information on how to set up the motion controller, refer to the *Machine Automation Controller NJ/NX-Series Startup Guide for Motion Control* (Cat. No. W514).

1.3. System Configuration

The following figure shows the system configuration and devices that are used in this Guide. The system configuration is shown in the following figure.

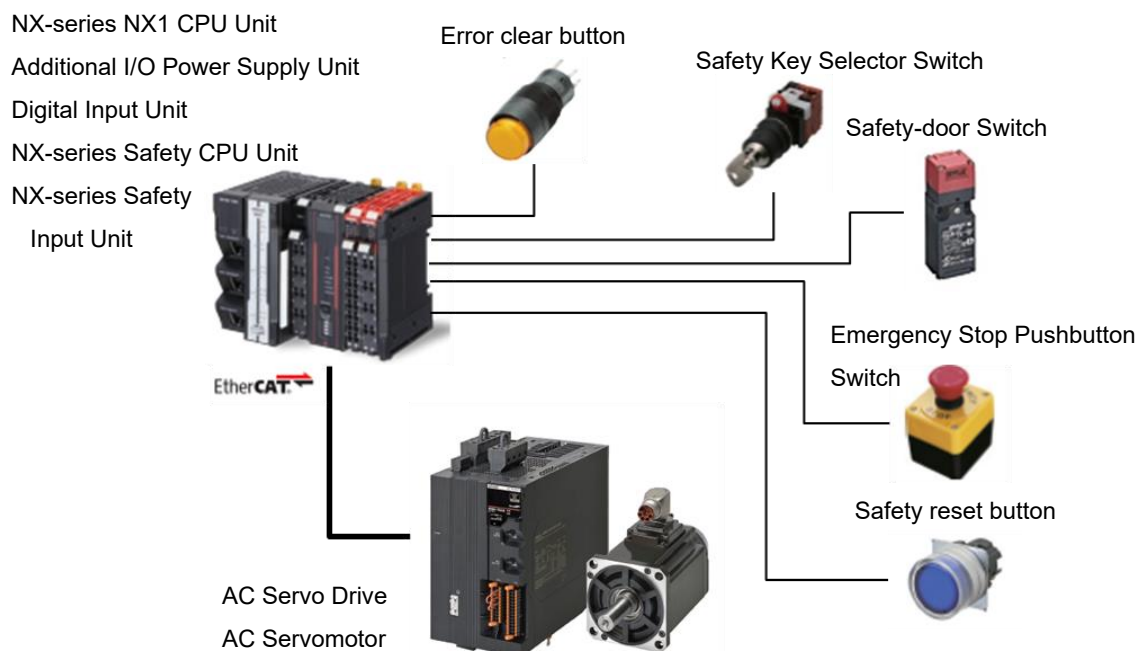

● Configuration Devices

The models of the devices that are described in this Guide are given in the following table. When selecting devices for an actual application, refer to the device manuals.

Device name	Model	Manual name
NX-series NX1 CPU Unit (Standard controller)	NX102-[]	NX-series NX102 CPU Unit Hardware User's Manual (W593)
Additional I/O Power Supply Unit	NX-PF0[]	NX-series System Units User's Manual (W523)
Digital Input Unit	NX-ID[]	NX-series Digital I/O Unit User's Manual (W521)
NX-series Safety CPU Unit (Safety controller)	NX-SL3300	NX-series Safety Control Unit User's Manual (Z930)
NX-series Safety Input Unit	NX-SID[]	
Ethernet/EtherCAT Communications Cable	XS5W-T[]	---
AC Servo Drive	R88D-1SAN[]	1S-series AC Servomotors/Servo Drives with Built-in EtherCAT Communications and Safety Functionality User's Manual (I621)
AC Servomotor	R88M-1A[]	
Integrated Cable	R88A-CX1[]	
Error clear button	A3[]	---
Safety Key Selector Switch	A22TK[]	---
Safety-door Switch	D4NS[]	---
Emergency Stop Pushbutton Switch	A22[]	---

● **Automation Software**

Product	Number of licenses	Model
Sysmac Studio Standard Edition Version 1.27	None (DVD only)	SYSMAC-SE200D
	From 1 license to site license	SYSMAC-SE[]

2. Before You Begin

■ Unpacking

1.	Unpack the motor package. The package includes only one Servomotor and the instruction sheet. Cables are provided separately.
2.	Unpack the drive package. The Servo Drive comes with the following accessories. <ul style="list-style-type: none">• INSTRUCTION MANUAL × 1 copy• Warning label × 1 sheet• General Compliance Information and instructions for EU × 1 copy• Attached connector

■ Installing the Sysmac Studio Standard Edition Version 1.27 or higher

Refer to the *Sysmac Studio Version 1 Operation Manual* (Cat. No. W504) for details on how to install the Sysmac Studio.



Additional Information

For further details on how to handle the drive and motor packages, refer to the *Items to Check After Unpacking* in the *1S-Series AC Servomotors/Servo Drives with Built-in EtherCAT Communications and Safety Functionality User's Manual* (Cat. No. I621).

3. Performing Setup

This section explains from assembling the hardware that makes up the servo system to adding the STO function via FSoE and creating a motor control program. The next section 4. *Adding a Safety Function* describes how to add safety functions other than the STO function.

The operation of the servo system set up in this section is explained below.

1. When the error clear button is pressed, the errors of the standard controller and Servo Drive are reset.
2. When the guard with the Safety-door Switch is opened, the motor torque is turned OFF.
3. When the Emergency Stop Pushbutton Switch is pressed, the motor torque is turned OFF.
4. When the safety reset button is pressed, the STO status is reset.

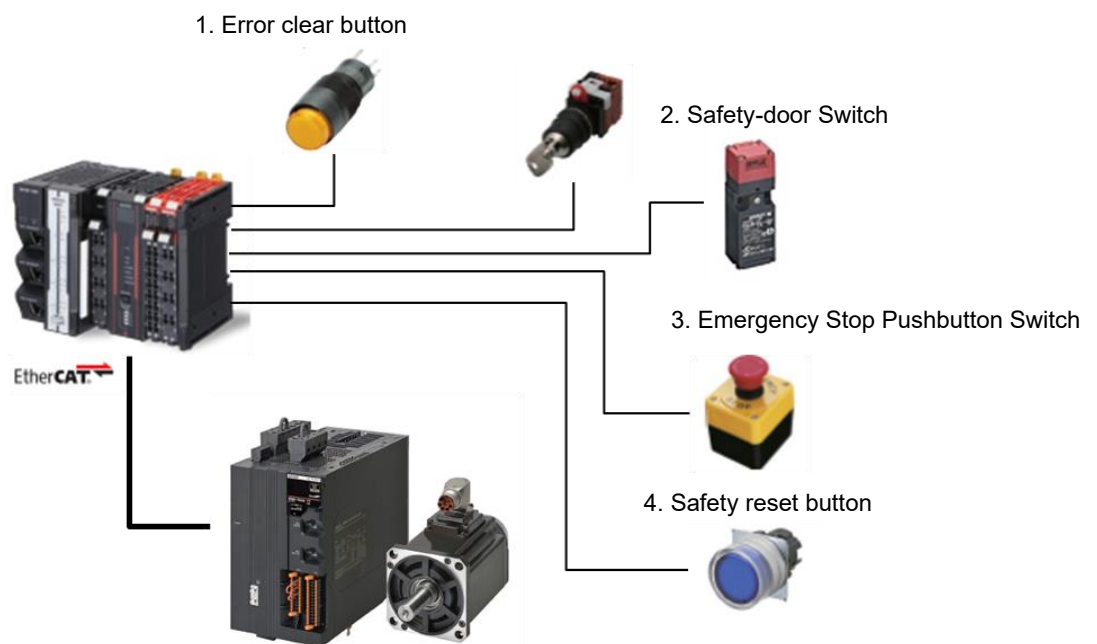

Input device	State	Operation
1. Error clear button	ON	Enable error reset command
	OFF	Disable error reset command
2. Safety-door Switch	Open	Enable STO command
	Close	Disable STO command
3. Emergency Stop Pushbutton Switch	ON	Enable STO command
	OFF	Disable STO command
4. Safety reset button	ON	Enable reset STO status command
	OFF	Disable reset STO status command

■ Operation of STO Function with Motion Control

1. When the Servo ON command is enabled, the Servo Drive turns ON the Servo.
2. When the STO function is executed, the Servo Drive shifts to the STO state and turns OFF torque.
3. When an operation command is enabled, the command velocity to the Servomotor is set to 600 r/min.

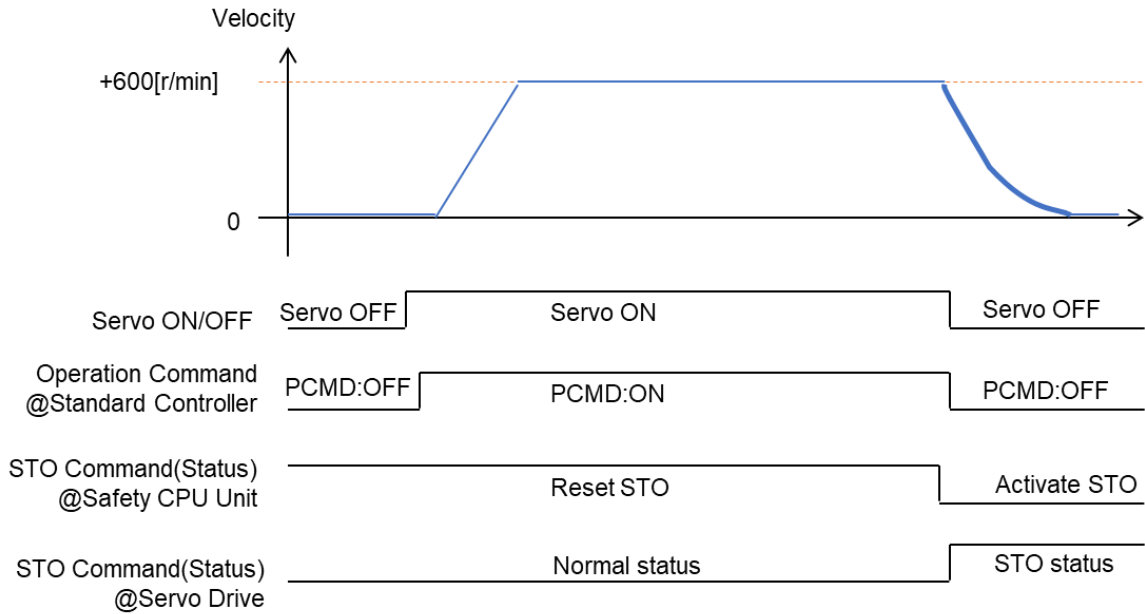

3.1. Installation and Wiring

Space Conditions around Servo Drives

Install the Servo Drive according to the following instructions.

● Single-unit Installation

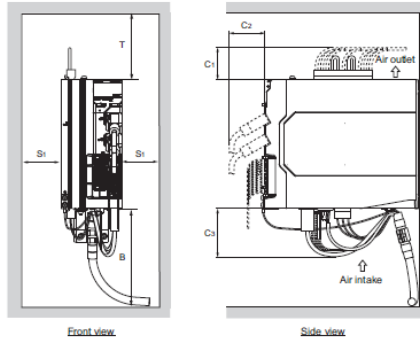

● Side-by-side Installation

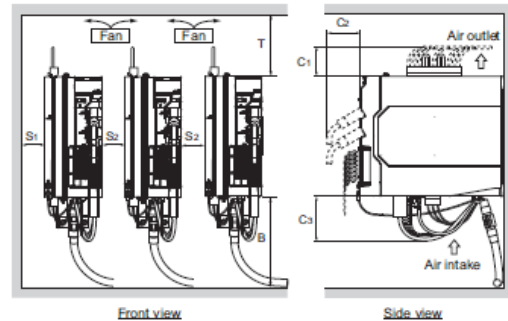

Dimension	Distance	
T	100 mm min.	
B	R88D-1SAN02H-ECT/-1SAN04H-ECT/-1SAN08H-ECT	150 mm min.
	R88D-1SAN10H-ECT/-1SAN15H-ECT/-1SAN20H-ECT/-1SAN30H-ECT/ -1SAN10F-ECT/-1SAN15F-ECT/-1SAN20F-ECT/-1SAN30F-ECT	180 mm min.
S ₁	40 mm min.	
S ₂	10 mm min.	
C ₁	R88D-1SAN02H-ECT/-1SAN04H-ECT/-1SAN08H-ECT/-1SAN10H-ECT	45 mm min.
	R88D-1SAN15H-ECT/-1SAN20H-ECT/-1SAN30H-ECT/-1SAN10F-ECT/ -1SAN15F-ECT/-1SAN20F-ECT/-1SAN30F-ECT	60 mm min.
C ₂	50 mm min.	
C ₃	80 mm min.	

- Install the Servo Drive on the vertical metal surface.
- To provide electrical conduction, remove any paint from the surface on which you install the Servo Drives. Also, it is recommended that you apply conductive plating if you make the mounting bracket by yourself.
- The recommended tightening torque for installing the Servo Drive is 1.5 N·m. Make sure that the threaded portion has the sufficient strength to withstand the recommended torque.
- You can install Servo Drives without the clearance of S₂ if the operating ambient temperature is from 0 to 45°C.
- When mounting the shield clamp, use the threads included in the Servo Drive or specified standard threads.
- Before installing the Servo Drive on the control panel, mount the shield clamp to the Servo Drive. Then connect the cable and fix the cable to the shield clamp.
- When you connect PC to the USB connector of the Servo Drive, separate the USB cable from other cables such as the main circuit power supply cable.

■ Mounting the Servo Drive

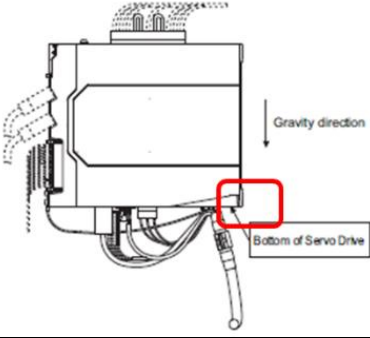
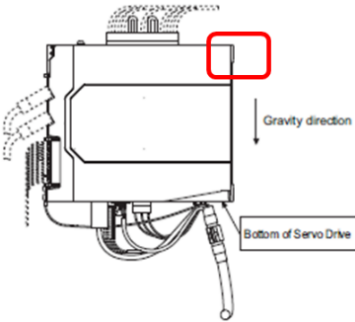
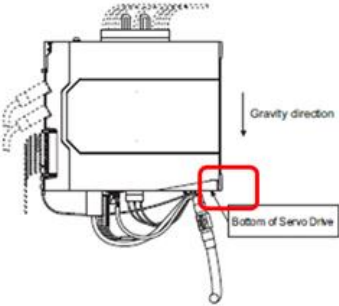
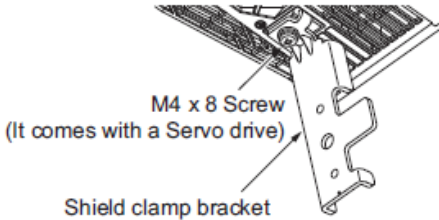
1.	<p>Put the Servo Drive in place and secure the top first and then the bottom.</p> <p>Temporarily tighten the screw to attach the lower part of the Servo Drive and slide the Servo Drive from top to bottom to put the U-groove of the Servo Drive on the screw.</p> 
2.	<p>Tighten the screw at the upper part.</p> 
3.	<p>Tighten the screw at the lower part.</p> 
4.	<p>Mount a shield clamp bracket to the Servo Drive.</p> <p>Tightening torque: 1.5 N•m</p> 

5. Mount the shield clamp plate to the shield clamp bracket.

Tightening torque: 1.5 N•m

- Do not cut cable ties.

■ **Mounting the Servomotor** (The order of step 2 and step 3 depends on your mechanical implementation.)

1. Handle the Servomotor carefully and do not apply heavy impacts or loads during transport, installation, or removal of the Servomotor.

2. Fix and connect the Servomotor to the mechanical system.
First, check motor operation without any load.

3. Connect the integrated cable.

Turn the knurling nut of a cable plug to counterclockwise direction.

Type M23 Connector

Align a mark of the motor receptacle with the printed “open” on the knurling nut.

Insert the knurling nut into the receptacle as far as it goes.

- **Type M17 Connector**

State of a knurling nut inserted to a motor receptacle firmly

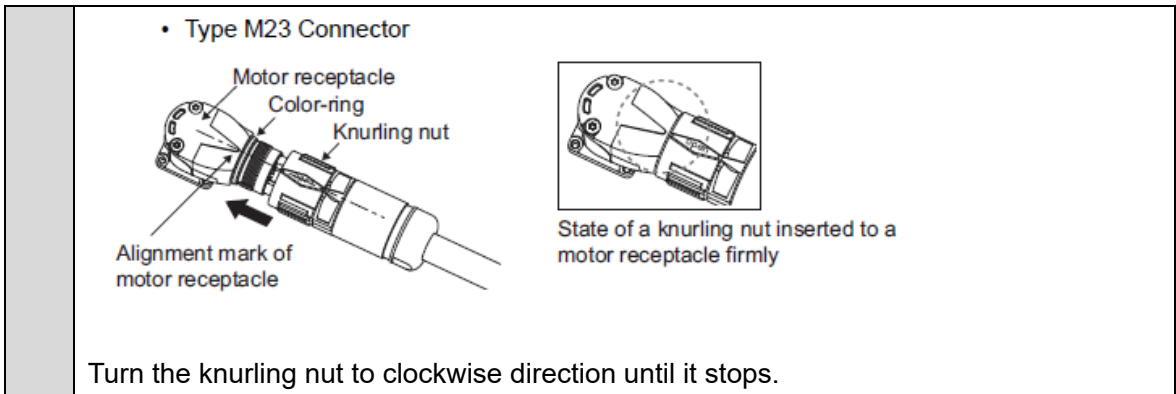

Additional Information

For further details on how to mount the Servomotor, refer to the *1S-series AC Servomotors/Servo Drives with Built-in EtherCAT Communications and Safety Functionality User's Manual (Cat. No. I621)*.

■ Wiring

1. **Overview**

■ Wiring Diagram

2. **Remove the main circuit connector (CNA), or the main circuit connector A (CNA) and control power supply connector (CND) from the Servo Drive.**





200 V (up to 1 kW) **200 V (1.5 - 3 kW) and 400 V (1 - 3 kW)**

R88D-1SAN02H-ECT/-1SAN04H-ECT/-1SAN08H-ECT/-1SAN10H-ECT R88D-1SAN15H-ECT/-1SAN20H-ECT/-1SAN30H-ECT/-1SAN10F-ECT/-1SAN15F-ECT/-1SAN20F-ECT/-1SAN30F-ECT

3. **Wire the 24 V control power supply.**

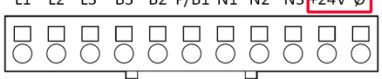
Connect wires with the spring opener.

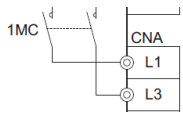
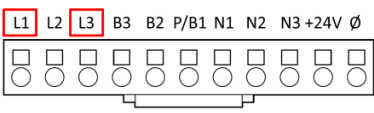
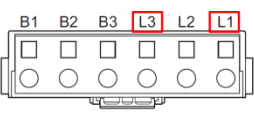
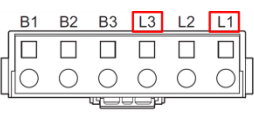
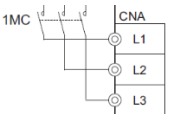
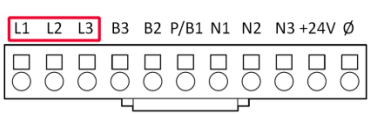
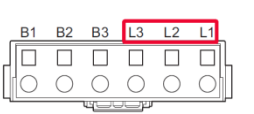
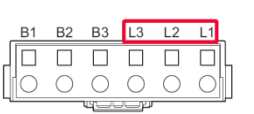
Check the connector corresponding to your Servo Drive and AC power supply.

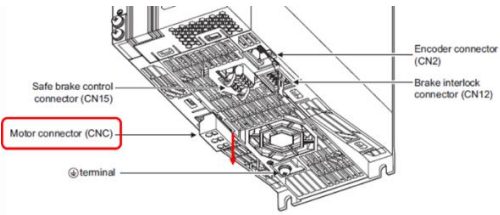
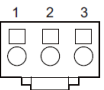
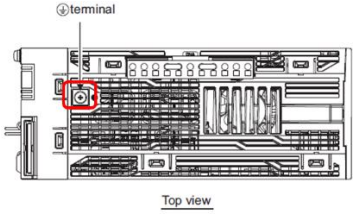
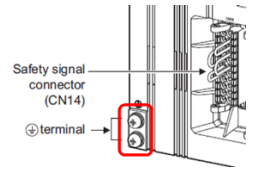
	<p>CNA for 200 V (up to 1 kW)</p> <p>L1 L2 L3 B3 B2 P/B1 N1 N2 N3 +24V \emptyset</p> 	<p>CND for 200 V (1.5 - 3 kW) and 400 V (1 - 3 kW)</p> <p>+24V \emptyset NC</p> 								
4.	<p>Wire the main circuit power supply. Check the connector corresponding to your Servo Drive and AC power supply.</p> <p>Single-phase</p> <div style="display: flex; justify-content: space-around;"> <div style="text-align: center;"> <p>200 V (up to 1 kW)</p>  <p>L1 L2 L3 B3 B2 P/B1 N1 N2 N3 +24V \emptyset</p>  </div> <div style="text-align: center;"> <p>200 V (1.5 kW)</p>  <p>B1 B2 B3 L3 L2 L1</p>  </div> </div> <p>3-phase</p> <div style="display: flex; justify-content: space-around;"> <div style="text-align: center;"> <p>200 V (up to 1 kW)</p>  <p>L1 L2 L3 B3 B2 P/B1 N1 N2 N3 +24V \emptyset</p>  </div> <div style="text-align: center;"> <p>200 V (1.5 - 3 kW) and 400 V (1 - 3 kW)</p>  <p>B1 B2 B3 L3 L2 L1</p>  </div> </div>  <p style="text-align: center;">Example: CNA for 200 V (up to 1 kW)</p>									
5.	<p>Remove the motor connector (CNC) from the Servo Drive.</p> 									
6.	<p>Connect the power line to the phase U, V, and W of the Servomotor.</p> <table border="1" style="display: inline-table; border-collapse: collapse;"> <thead> <tr> <th>Pin No.</th> <th>Name</th> </tr> </thead> <tbody> <tr> <td>1</td> <td>U</td> </tr> <tr> <td>2</td> <td>V</td> </tr> <tr> <td>3</td> <td>W</td> </tr> </tbody> </table> 		Pin No.	Name	1	U	2	V	3	W
Pin No.	Name									
1	U									
2	V									
3	W									
7.	<p>Screw the PE wire of the main circuit power supply cable to the Servo Drive.</p>  <p style="text-align: center;">Top view</p>									
8.	<p>Plug back the above connectors to the Servo Drive. (Power and motor)</p>									
9.	<p>Screw the FG wire of the motor cable to the Servo Drive.</p> 									

10. **Plug the encoder cable into the Servo Drive. (CN2)**

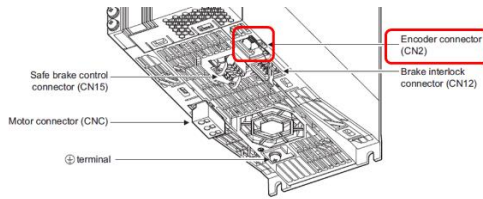

11. **When you use a motor with a brake, plug the brake cable into the Servo Drive. (CN12)**

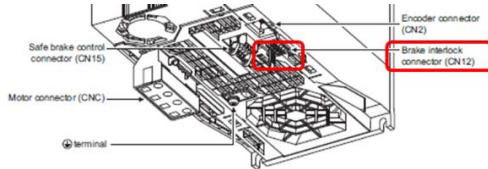

Pin No.	Symbol	Signal name	Pin No.	Symbol	Signal name
1	SBC PS	24-V power supply for SBC (+)	5	SBC CM	24-V power supply for SBC (-)
2	SBC PS	24-V power supply for SBC (+)	6	SBC RFB	SBC relay feedback input
3	S1+	SBC1+	7	S1-	SBC1-
4	S2+	SBC2+	8	S2-	SBC2-

● Connector for CN15 (8 Pins)

Model	Manufacturer	Omron model
DFMC1,5/4-ST-3,5-LRBK	PHOENIX CONTACT	R88A-CN102S

Applicable wire: AWG 24 to 16 (0.2 to 1.5 mm²) (Strip length of the wire insulating cover: 10 mm)

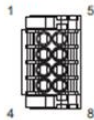

Additional Information

For further details on wiring, refer to the *1S-series AC Servomotors/Servo Drives with Built-in EtherCAT Communications and Safety Functionality User's Manual* (Cat. No. I621).

■ Safety Wiring

1 By default, hard-wired STO is disabled and bypassed with jumpers.

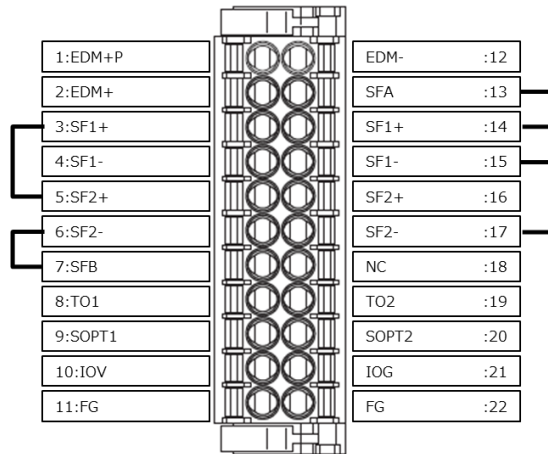

2 When using hard-wired STO, make the wiring between the Safety CPU Unit and the Servo Drive as shown below.

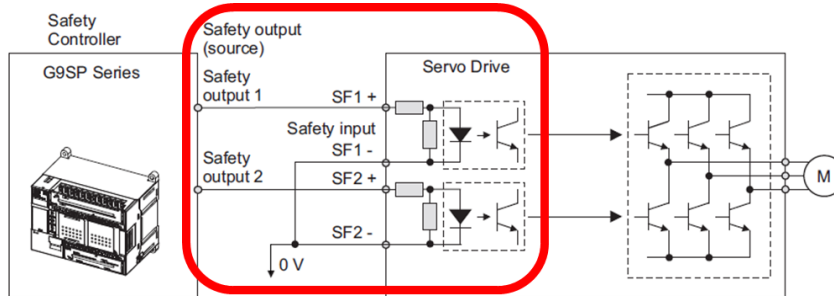

Wire SF1 and SF2 to different safety outputs.

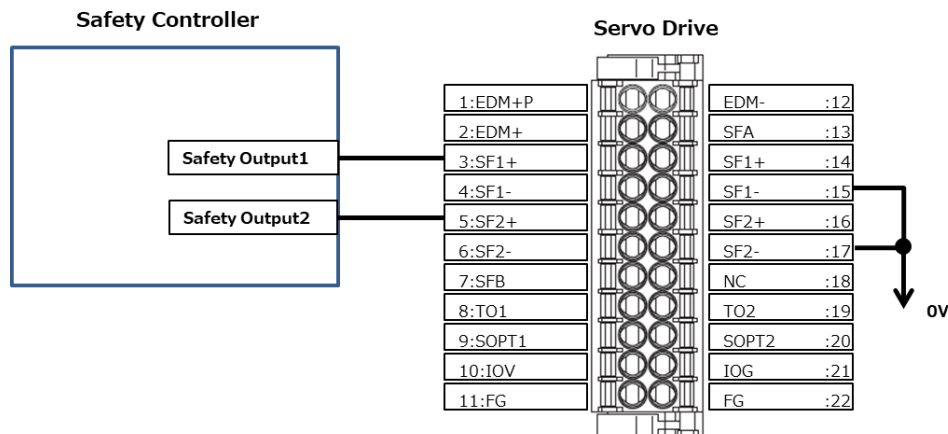

3 When using hard-wired STO for multiple Servo Drives, make the wiring between the Safety CPU Unit and the Servo Drives as shown below.

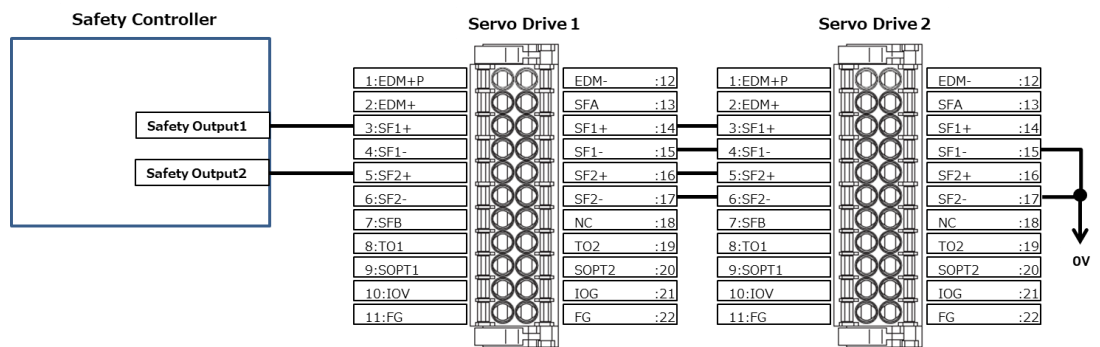
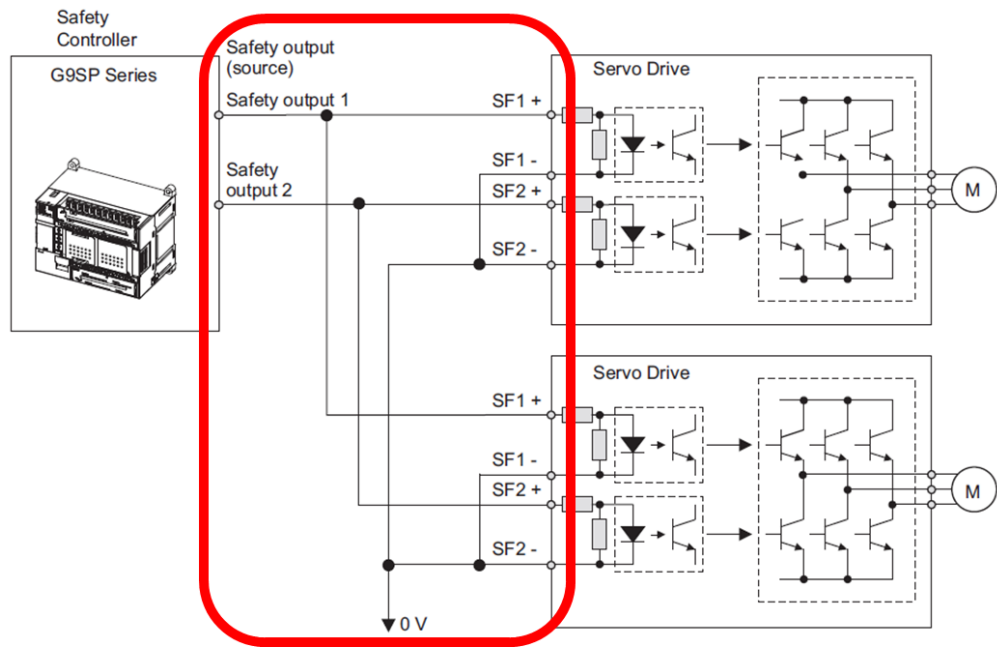

Note: When using a G9SP-series Safety Controller, you can connect up to four 1S-series Servo Drives.

I/O Wiring

When using general-purpose I/O, make the wiring as shown below.

Example of Latch Input 1:

Control I/O Signal Connections and External Signal Processing

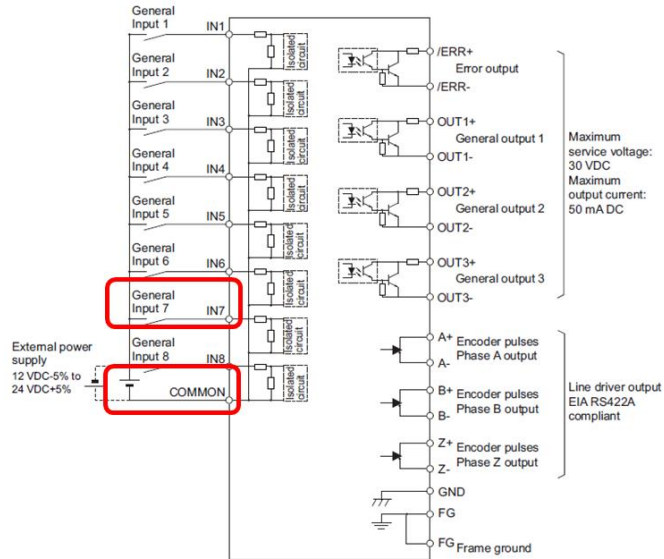

Servo Drive connector view:

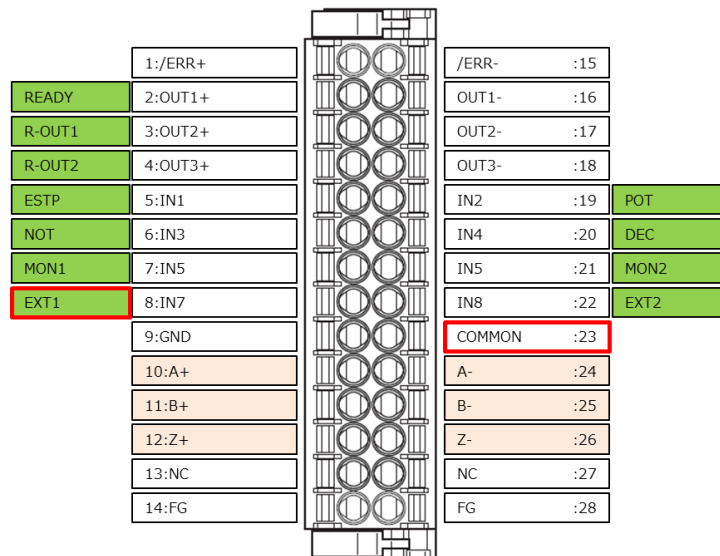

Additional Information

For further details on wiring, refer to the *1S-series AC Servomotors/Servo Drives with Built-in EtherCAT Communications and Safety Functionality User's Manual* (Cat. No. I621).

3.2. System Configuration with Standard and Safety Controllers

■ EtherCAT Node Address Configuration

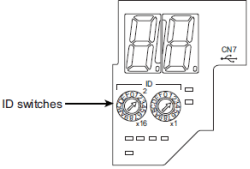
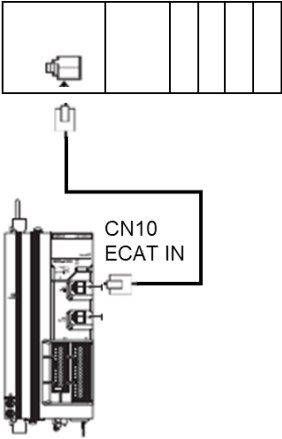
1.	<p>Use the ID switches to set the EtherCAT node address of the Servo Drive to 1.</p>  <p>ID switches</p>
2.	<p>Connect an EtherCAT communications cable to the device.</p> <p>ECAT IN CN10: EtherCAT cable from NX102 CPU Unit</p>  <p>EtherCATMaster I/O Power Supply Unit NX Safety CPU Unit NX Safety Input/Output Unit Digital Input/Output Unit</p> <p>CN10 ECAT IN</p>



Additional Information

For further details on the Safety Control Unit, refer to the *NX-series Safety Control Unit User's Manual* (Cat. No. Z930).

3.3. Sysmac Studio Project Creation

■ Creating a Network Configuration

1. Select the NX102-9000 Controller from the list.

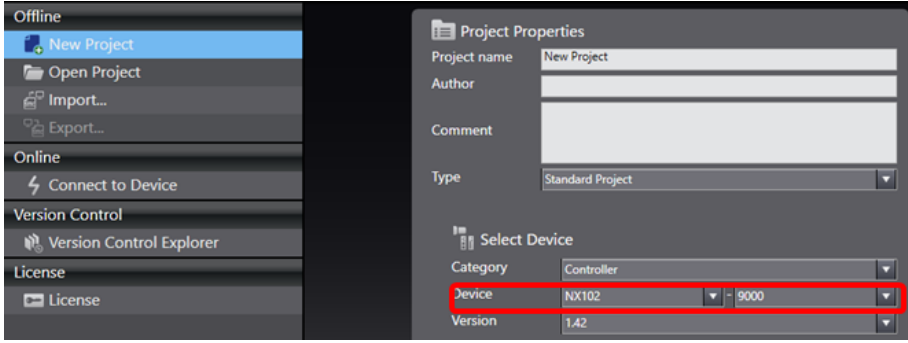

Note: When using the motor sizing tool results file, refer to the *Adding a Servo Drive and Axis from Motor Sizing Tool Results* under Appendices.
2. Double-click **EtherCAT** under **Configurations and Setup** in the Multiview Explorer.

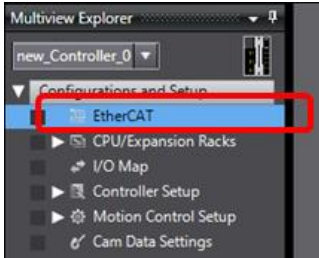

The EtherCAT Tab Page is displayed in the Edit Pane.

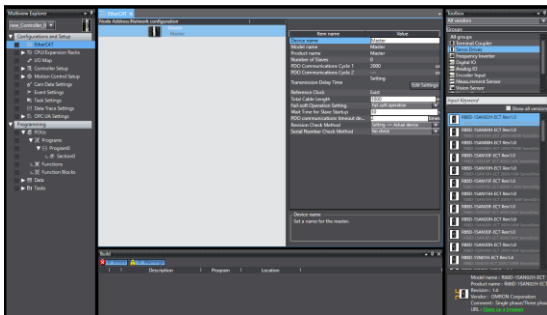
3. Drag a Servo Drive from the Toolbox to the Master in the EtherCAT Tab Page.

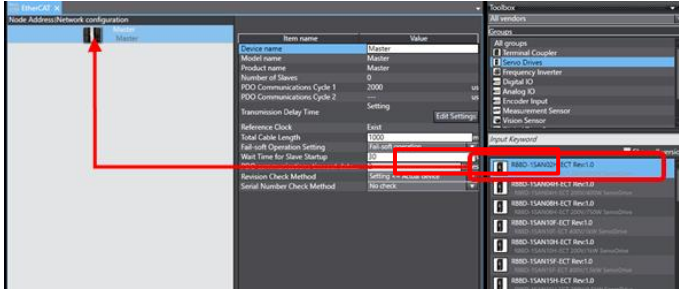

The Servo Drive with a node address of 1 is added under the Master.

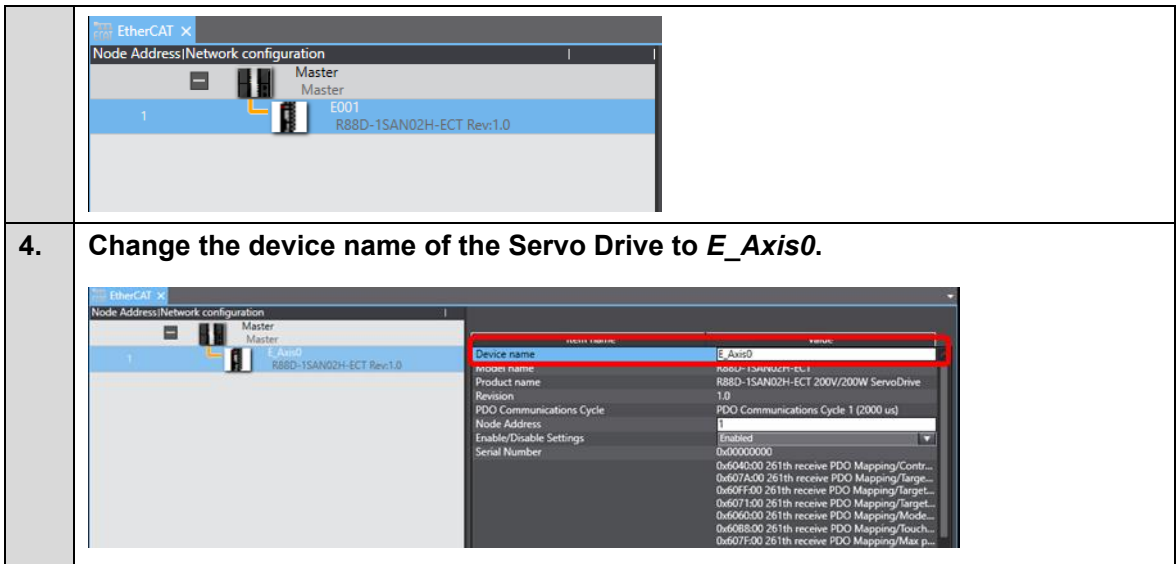

Additional Information

If the physical EtherCAT network configuration is already connected, you can automatically create the virtual network configuration on the Sysmac Studio from the physical network configuration.

Refer to the *Sysmac Studio Version 1 Operation Manual* (Cat. No. W504) for the procedure.

■ Setting an Axis

This section describes how to add the axis that is used to control the Servo Drive, assign the Servo Drive, and set the axis parameters.

1. **Right-click *Axis Settings* in the Multiview Explorer and select *Add - Motion Control Axis* from the menu.**

The axis *Axis0* is added to the Multiview Explorer. This added axis is called the axis 0.

2. Right-click **Axis0** (axis 0) in the Multiview Explorer and select **Edit** from the menu.



The Axis Basic Settings view is displayed on the Axis Parameter Settings Tab Page in the Edit Pane.

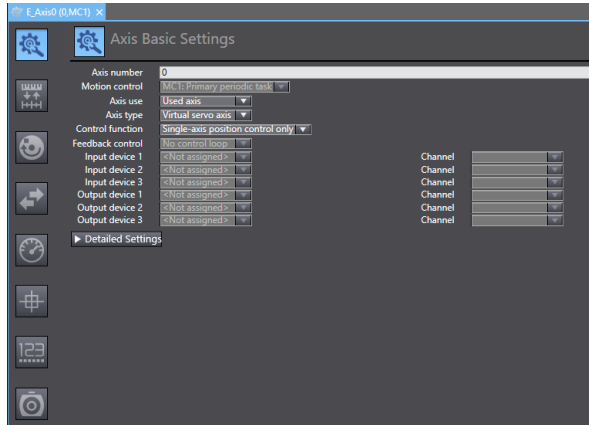

3. Select **Servo axis** for the **Axis type** setting.

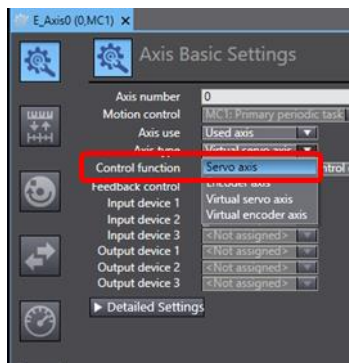

4. Select the **Servo Drive** to use for the **Output device 1** setting.

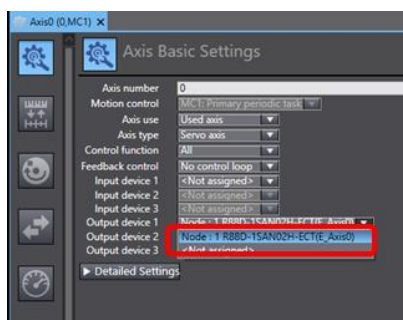

This will assign the node: 1 Servo Drive to the Output device 1 for axis 0.

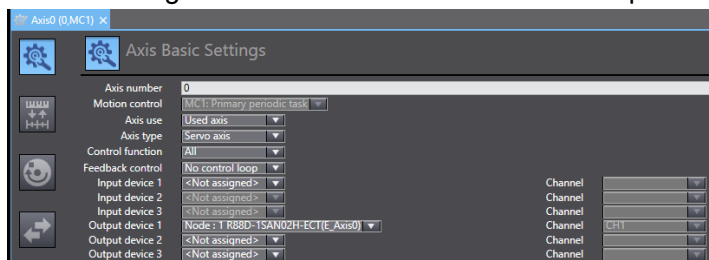

5. Set the parameters on the Axis Parameter Settings Tab Page.

The following figure shows the axis parameters for the unit conversion settings.

Unit of display: pulse

Command pulse count per motor rotation: 1,048,576 pulse/rev

Work travel distance per motor rotation: 1,048,576 pulse/rev

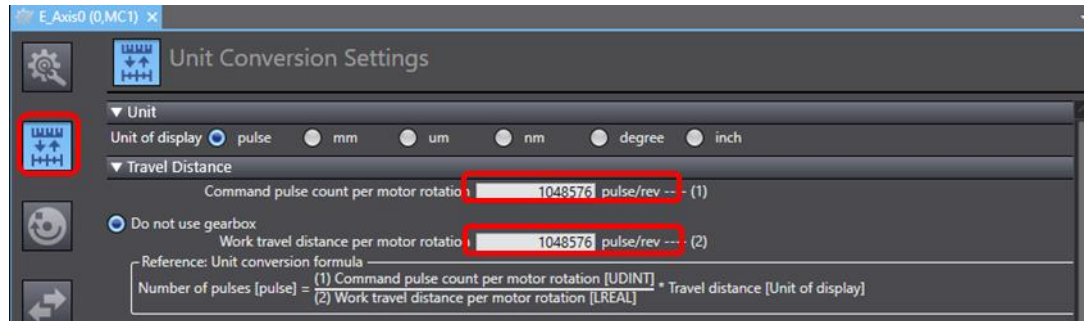

6. Operation Settings

Maximum velocity: 52,428,800 pulse/s (3,000 r/min)

Maximum jog velocity: 1,048,576 pulse/s (60 r/min)

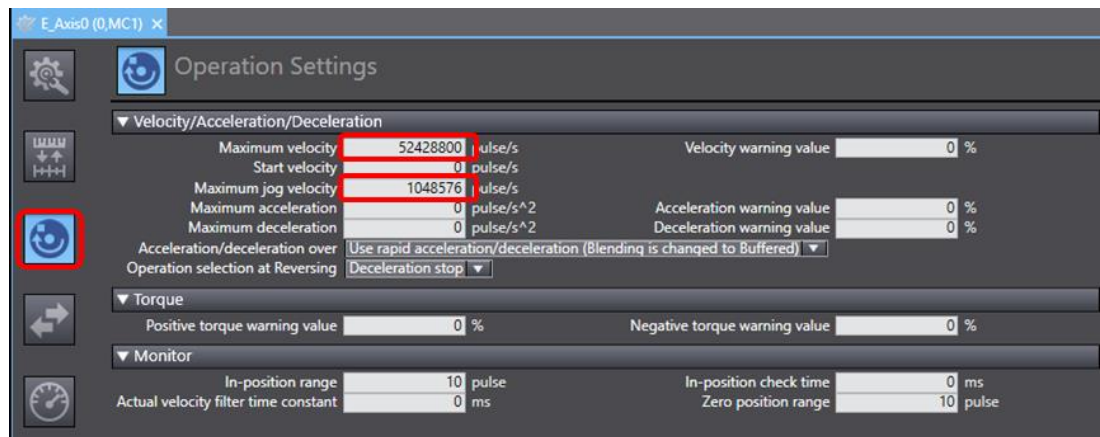

7. Position Count Settings

Count mode: Linear mode

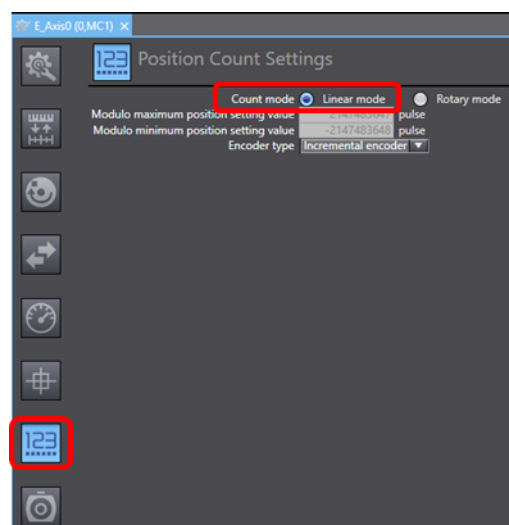

■ Setting the Network Configuration

1. Double-click **CPU Rack**.

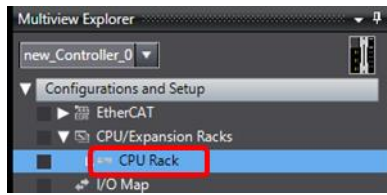

2. Drag a system unit device to the location where you want to add it in the **CPU and Expansion Racks Tab Page**.

In this example, drag the NX-PF0630 Additional I/O Power Supply Unit.

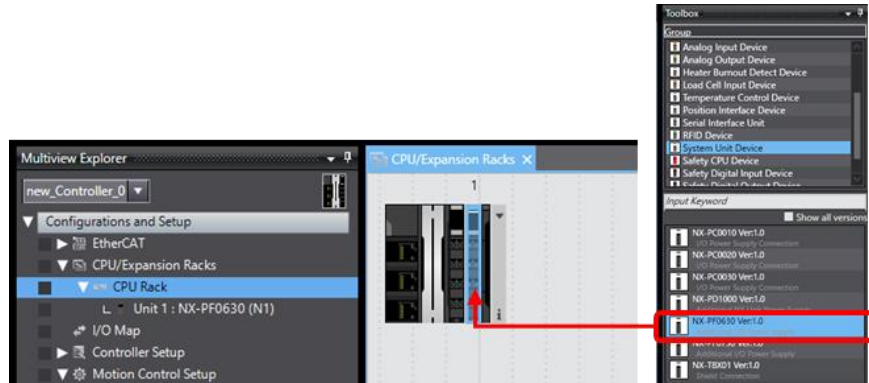

3. Drag a safety CPU device to the location where you want to add it in the **CPU and Expansion Racks Tab Page**.

In this example, drag the NX-SL3300 Safety CPU Unit.

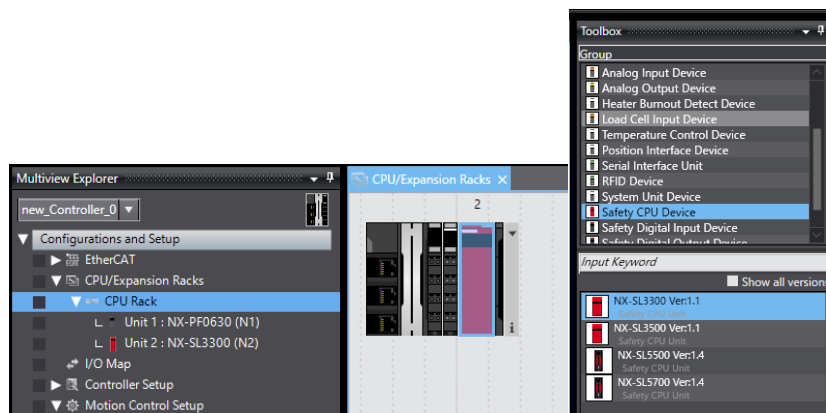

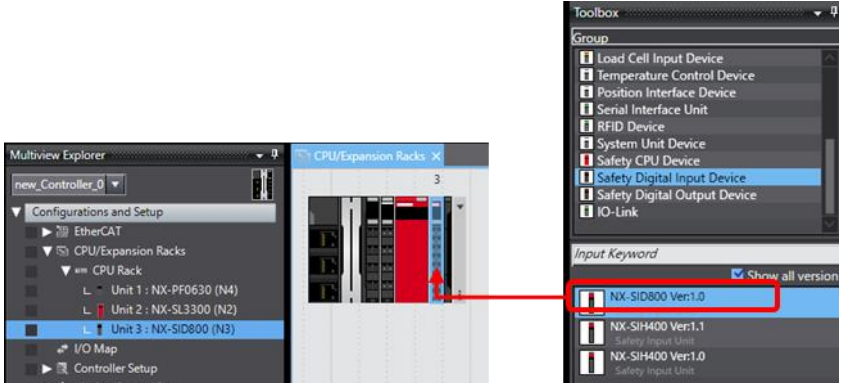
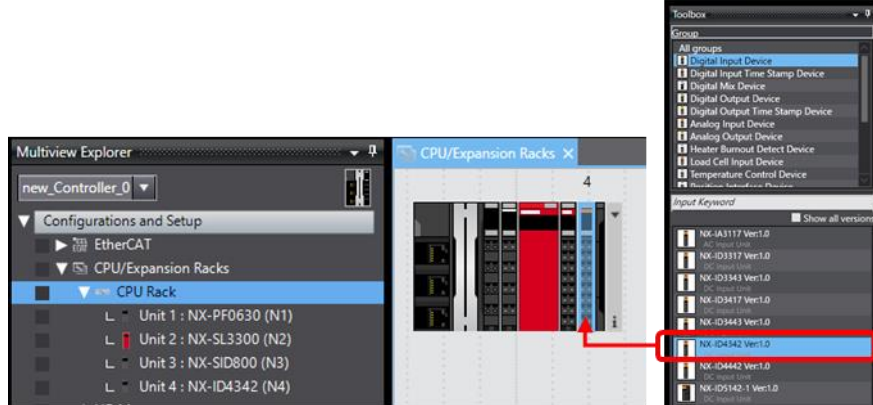
4. **Drag a safety digital input device to the location where you want to add it in the CPU and Expansion Racks Tab Page.**
In this example, drag the NX-SID800 Safety Input Unit.

5. **Drag a digital input device to the location where you want to add it in the CPU and Expansion Racks Tab Page.**
In this example, drag the NX-ID4342 Digital Input Unit.

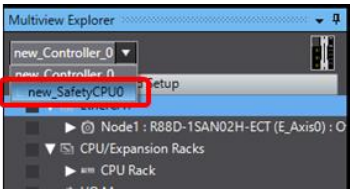
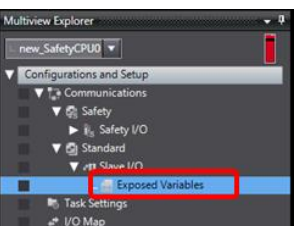
6. **Turn ON the power supply to all devices.**

■ Setting to Transfer Data from the Standard Controller to the Safety Controller

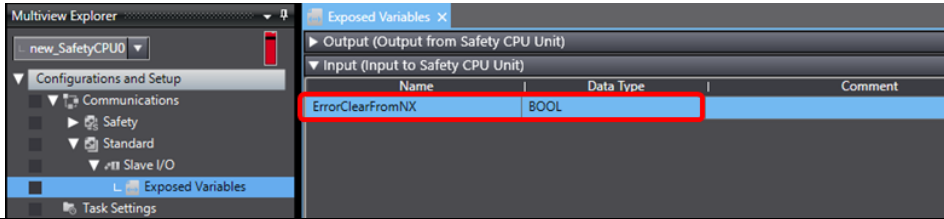
1. **Select *new_SafetyCPU0* from the list.**

2. **Double-click *Exposed Variables*.**

3. Add the *ErrorClearFromNX* BOOL variable to Input (Input to the Safety CPU Unit).

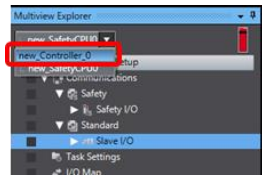

4. Select *new_Controller_0* from the list.



5. Open the I/O Map and create device variables.

Port	Variable name
ErrorClearFromNX	ErrorClearToSafetyCPU
Input Bit 00	ErrorClearSW

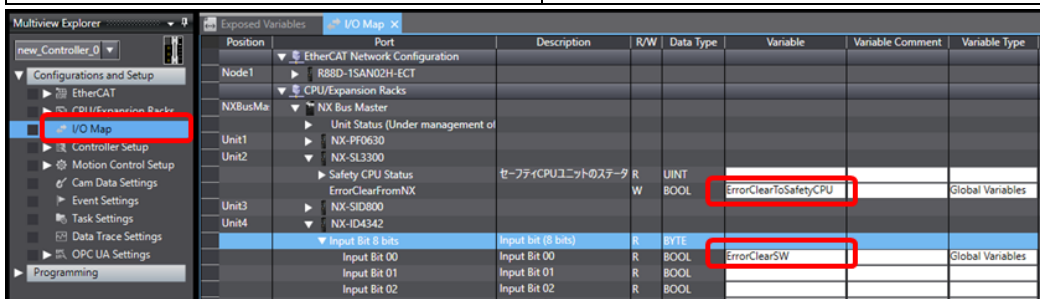

6. Double-click *Section0* to create a ladder program that transfers *ErrorClearSW* to the safety controller.



■ Setting the Safety Controller

This section describes how to set safety input devices.

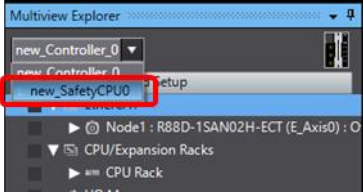
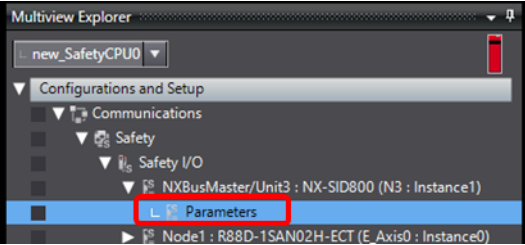
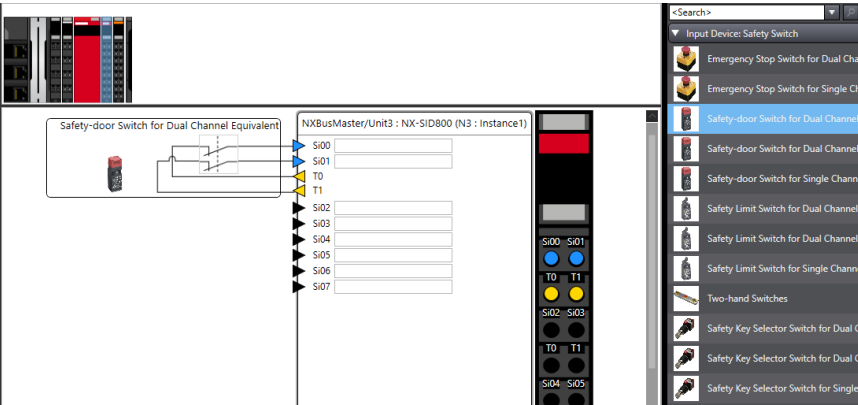
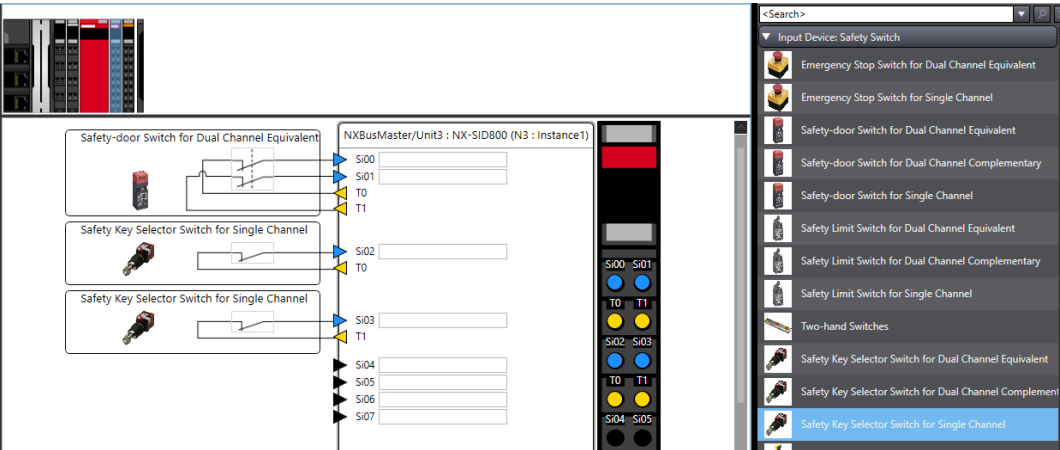
1. **Select `new_SafetyCPU0` from the list.**

2. **Double-click `Parameters`.**

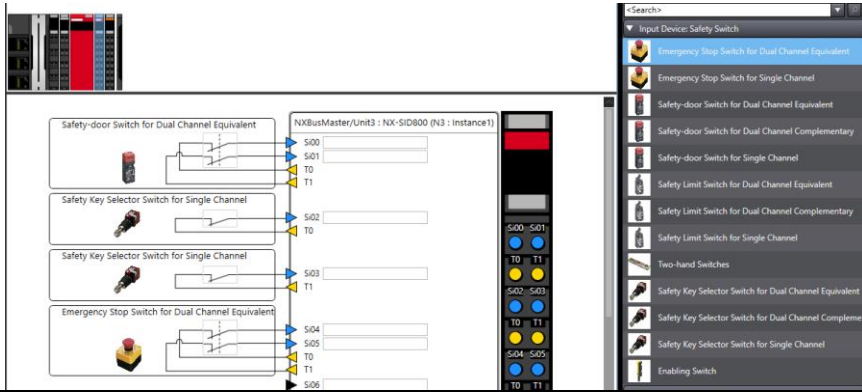
3. **Drag a Safety-door Switch to the desired I/O terminal.**

4. **Drag two safety key selector switches for single channel to the desired I/O terminals.**

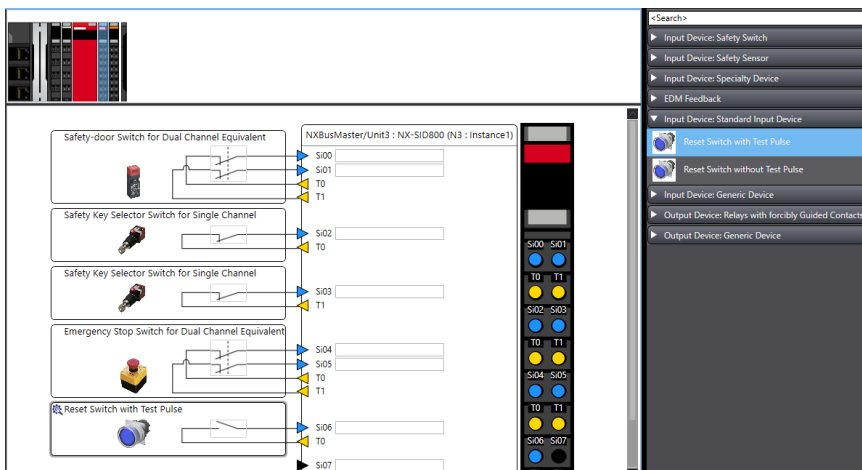
5. Drag an emergency stop pushbutton switch to the desired I/O terminal.



6. Drag a reset switch to the desired I/O terminal.



7. Double-click I/O Map.

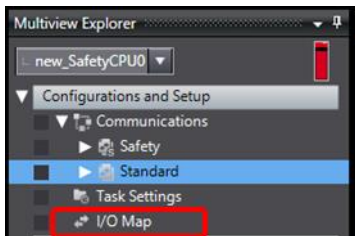

8. Create device variables for the safety input devices.

Port	Variable name
Si00 Logical Value	SI_DoorSwitch
Si02 Logical Value	SI_KeySelectorSwitch1
Si03 Logical Value	SI_KeySelectorSwitch2
Si04 Logical Value	SI_E_Stop
Si06 Logical Value	SI_ResetSignal

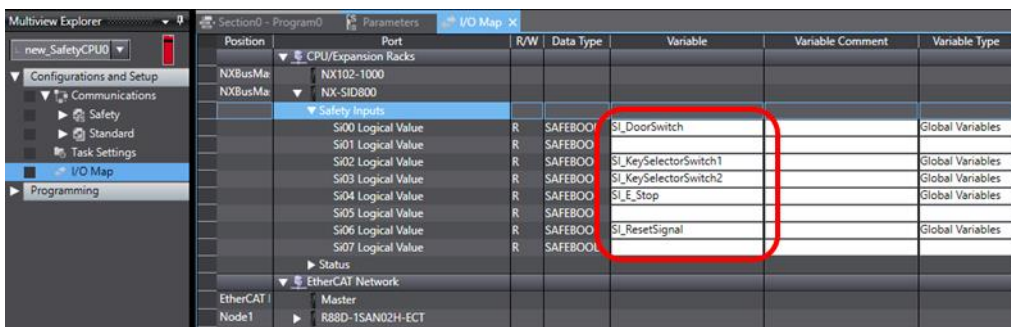

9. **Double-click *SRA Parameters*.**

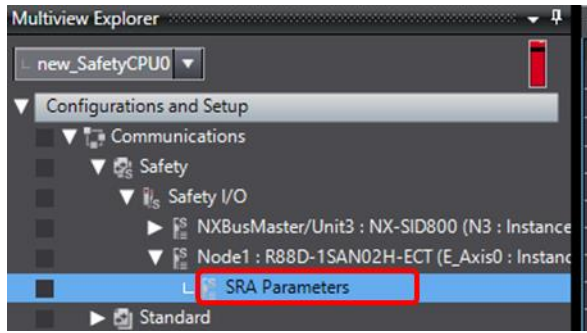

10. **Click the *Common Settings* Button and set the *Motor Rotation Direction* Field and the *Safety Position/Velocity Validation Monitoring Function* Field.**

Set *Safety Motor Rotation Direction Selection (4F03.00hex)* and *Motor Rotation Direction Selection (3000.01hex)* to the same value. Make sure that *Safety Position/Velocity Validation Monitoring Function* is set to *Enabled*.

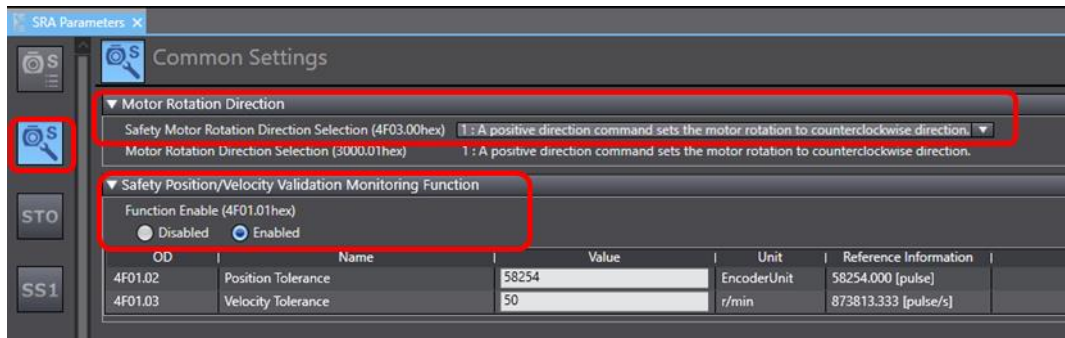

11. **Deactivate safety functions except for the *STO* function.**

Clear the selections of the *Active* Check Boxes for *SS1 instance1*, *SS2 instance1*, *SOS instance1*, *SDIp*, and *SDIn* to deactivate the unused safety functions.

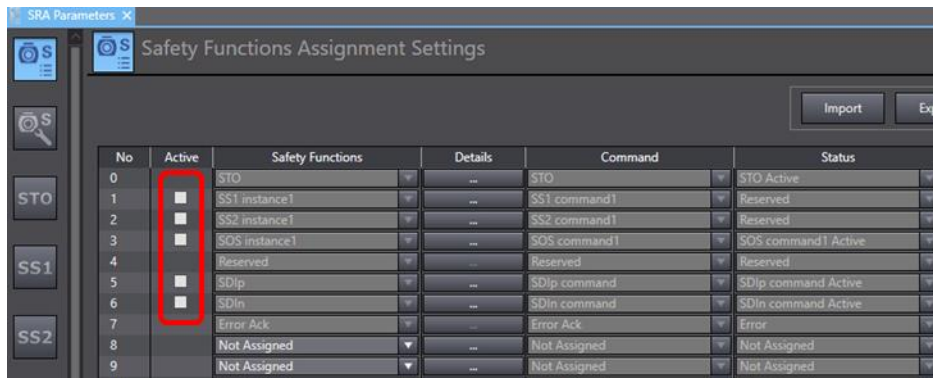

■ Creating a Safety Program

Create a safety program by following the steps below:

1. Create device variables.
2. Create a safety program using the Automatic Programming function.
3. Modify the created safety program.

1. Create device variables.

1. **Select *new_SafetyCPU0* from the list and double-click *I/O Map*.**

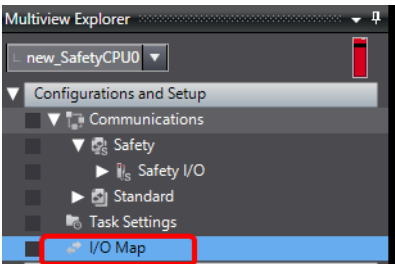

2. **Create device variables.**

Port	Variable name
Safety Connection Status for NX-SID800	N3_Safety_Connection_Status
STO Active for R88D-1SAN02H-ECT	E_Axis0_STO_Active
Error for R88D-1SAN02H-ECT	E_Axis0_Error
Safety Connection Status for R88D-1SAN02H-ECT	E_Axis0_Safety_Connection_Status
STO for R88D-1SAN02H-ECT	E_Axis0_STO
Error Ack for R88D-1SAN02H-ECT	E_Axis0_Error_Ack

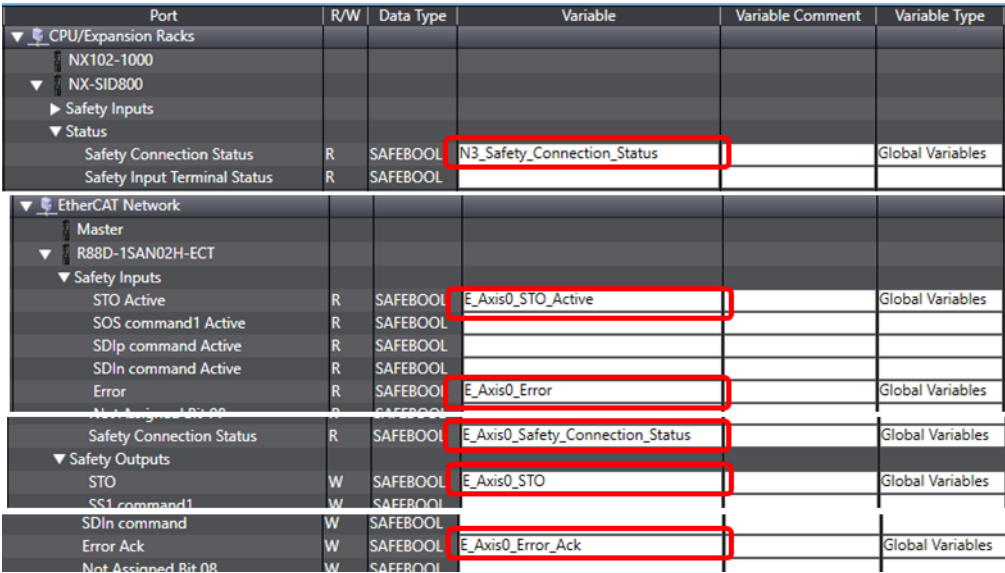

Port	R/W	Data Type	Variable	Variable Comment	Variable Type
CPU/Expansion Racks					
NX102-1000					
NX-SID800					
Safety Inputs					
Status					
Safety Connection Status	R	SAFEBOOL	N3_Safety_Connection_Status		Global Variables
Safety Input Terminal Status	R	SAFEBOOL			
EtherCAT Network					
Master					
R88D-1SAN02H-ECT					
Safety Inputs					
STO Active	R	SAFEBOOL	E_Axis0_STO_Active		Global Variables
SOS command1 Active	R	SAFEBOOL			
SDIp command Active	R	SAFEBOOL			
SDIn command Active	R	SAFEBOOL			
Error	R	SAFEBOOL	E_Axis0_Error		Global Variables
Not Assigned Bit 08	R	SAFEBOOL			
Safety Connection Status	R	SAFEBOOL	E_Axis0_Safety_Connection_Status		Global Variables
Safety Outputs					
STO	W	SAFEBOOL	E_Axis0_STO		Global Variables
SS1 command1	W	SAFEBOOL			
SDIn command	W	SAFEBOOL			
Error Ack	W	SAFEBOOL	E_Axis0_Error_Ack		Global Variables
Not Assigned Bit 08	W	SAFEBOOL			

2. Create a safety program using the Automatic Programming function.

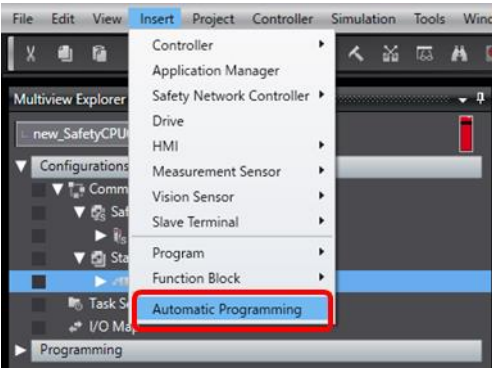
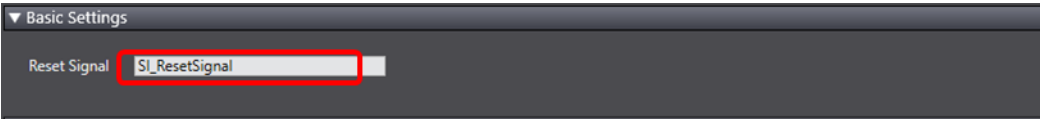
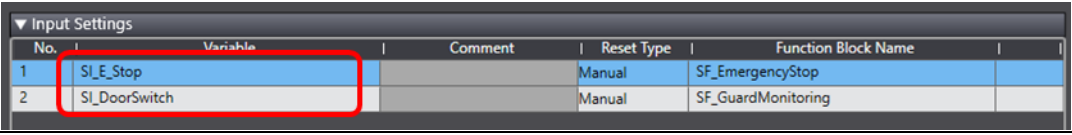
1. **Click *Automatic Programming* from the Insert Menu.**

2. **Set the reset signal to *SI_ResetSignal* in the Basic Settings Field.**

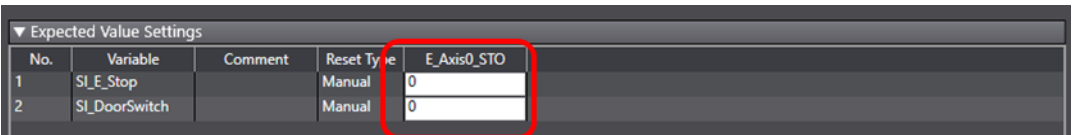
3. **Set *SI_E-Stop* and *SI_DoorSwitch* in the Input Settings Field.**

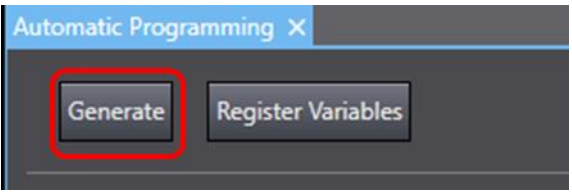
No.	Variable	Comment	Reset Type	Function Block Name
1	SI_E_Stop		Manual	SF_EmergencyStop
2	SI_DoorSwitch		Manual	SF_GuardMonitoring
4. **Set *E_Axis0_STO* in the Output Settings Field.
Set the *Use EDM* Column to *TRUE*.**

No.	Variable	Comment	Use EDM
1	E_Axis0_STO		TRUE
5. **Set the *E_Axis0_STO* Column to *0* for the *SI_E-Stop* and *SI_DoorSwitch* variables in the Expected Value Settings Field.**

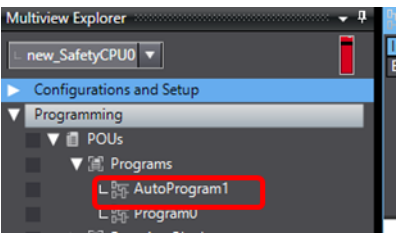
No.	Variable	Comment	Reset Type	E_Axis0_STO
1	SI_E_Stop		Manual	0
2	SI_DoorSwitch		Manual	0
6. **Click the *Generate* Button to create a safety program.**

AutoProgram1 is added.



3. Modify the created safety program.

1. Double-click *AutoProgram1*.

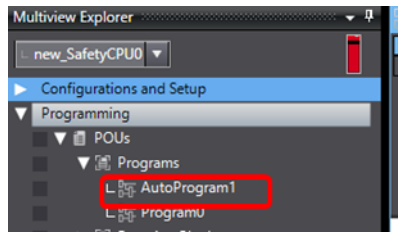

The program shown below appears.

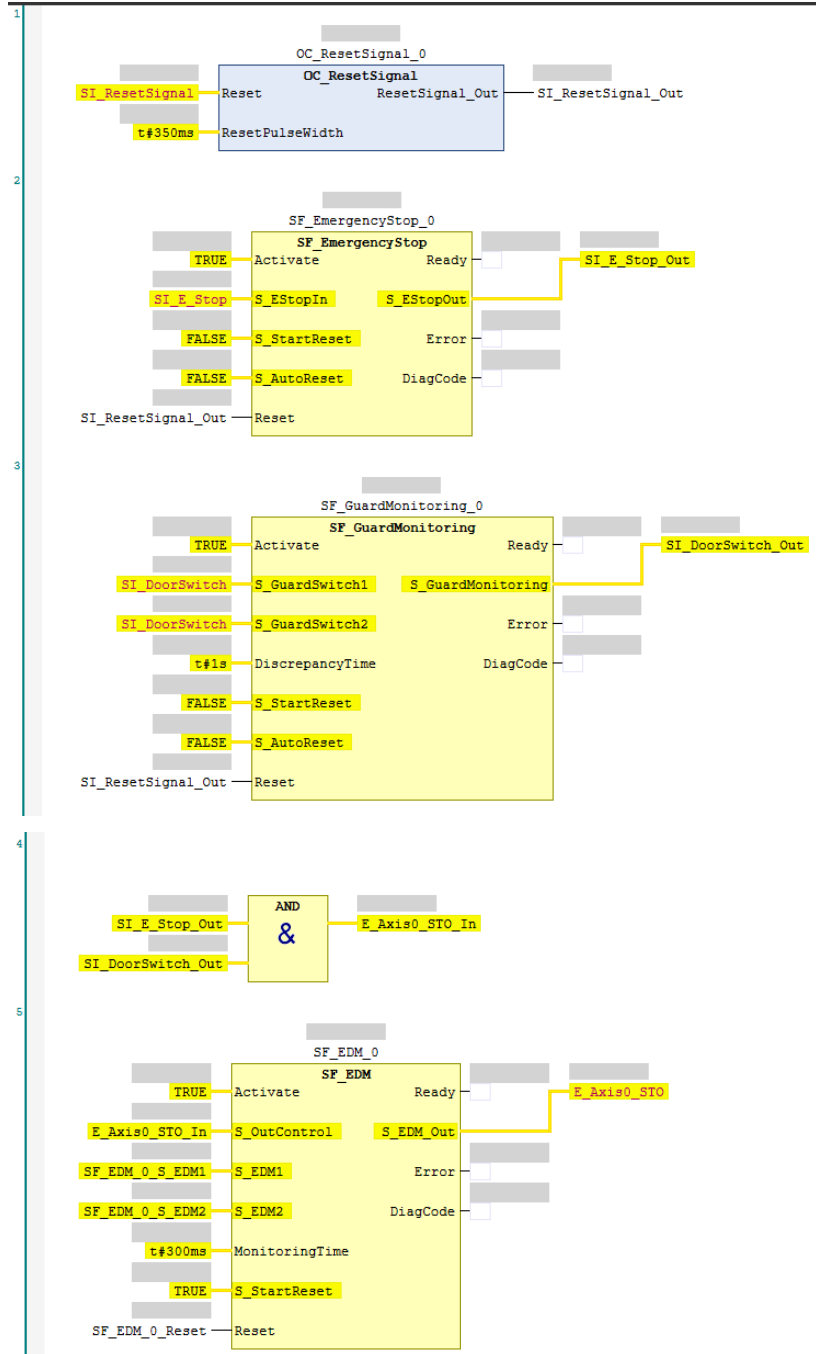

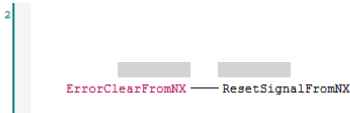
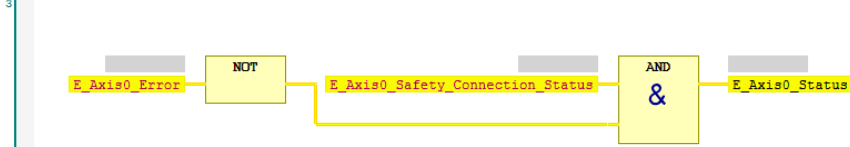
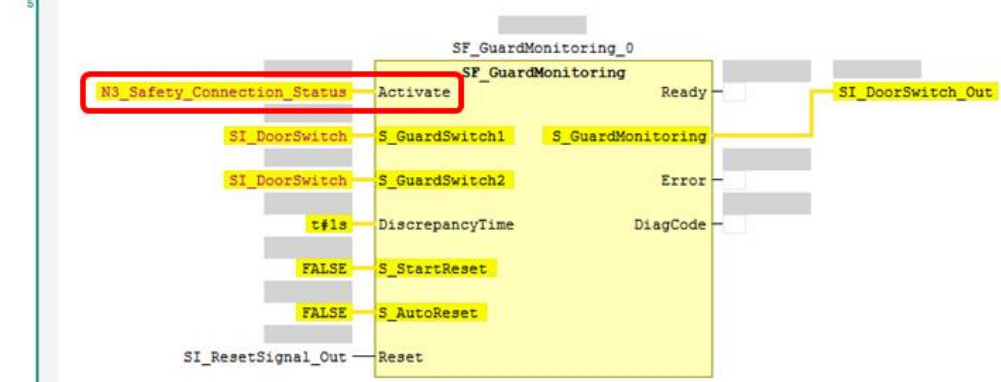
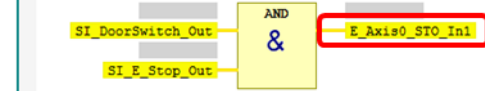
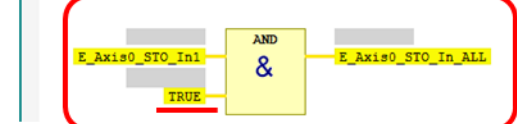
2.	<p>Add the code to assign <i>ErrorClearFromNX</i> to the <i>ResetSignalFromNX</i> local variable.</p> 
3.	<p>Add the following code. This is used to enable the function block that uses safety functions of the Servo Drive.</p> 
4.	<p>Set the input parameter to the <i>Activate</i> input variable to <i>N3_Safety_Connection_Status</i> in the <i>SF_GuardMonitoring</i> function block. When the FSoE communications are established for the NX-SID800 Safety Input Unit, this function block is enabled.</p> 
5.	<p>Change the output variable from <i>E_Axis0_STO_IN</i> to <i>E_Axis0_STO_IN1</i>.</p> 
6.	<p>Add the following code. The STO command is enabled by the emergency stop input or a Safety-door Switch, and sometimes by another device such as a robot. When the other device enables the STO command, assign the STO signal from the other device to <i>TRUE</i>.</p> 

7. Set the input parameter to the *Activate* input variable to *E_Axis0_Status* and the input parameter to the *Reset* input variable to *SI_ResetSignal_Out* in the **SF_EDM** function block

When the FSoE communications are established between the safety controller and Servo Drive and there is no error of safety functions in the Servo Drive, this function block is enabled.

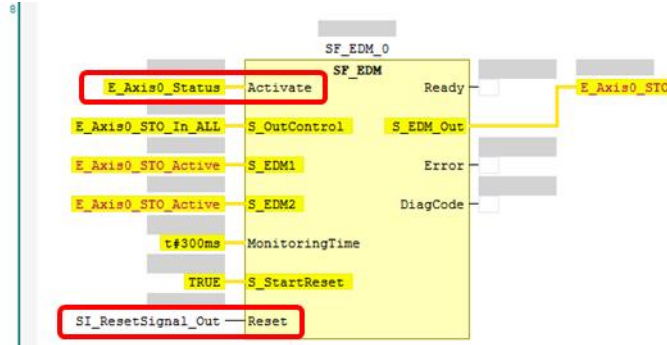

8. Add the code to reset errors of safety functions in the Servo Drive.

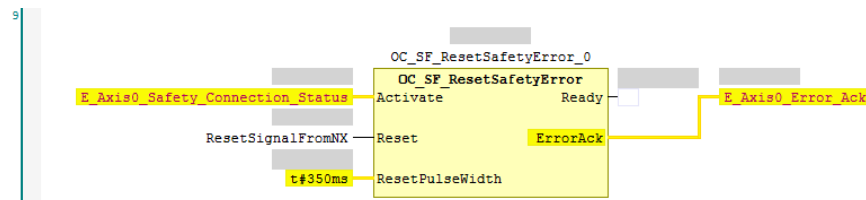

9. Check that the created program is the same as shown below.

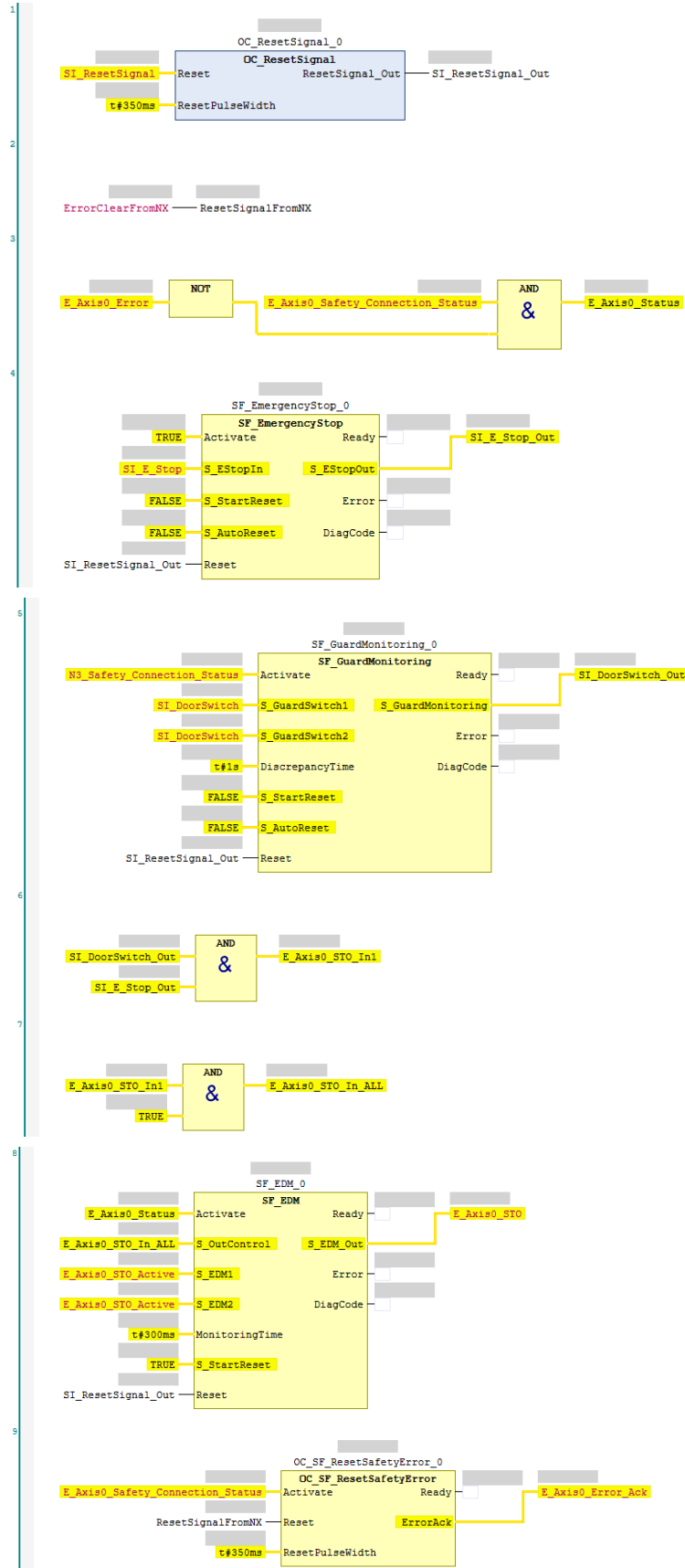

10. Delete **Program0**.

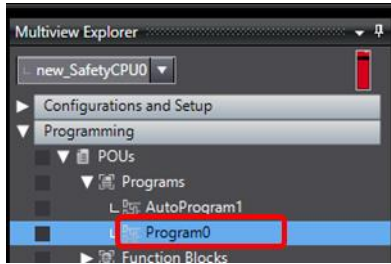

11. Connect to the standard controller.

Change the connection method

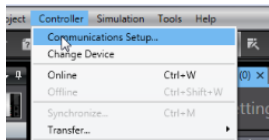

Test the connection.



Confirm that **Test OK** is displayed and connect to the standard controller.



12. Transfer to the standard controller.

Click the **Synchronization** Button to synchronize with the standard controller.



Transfer to the standard controller.

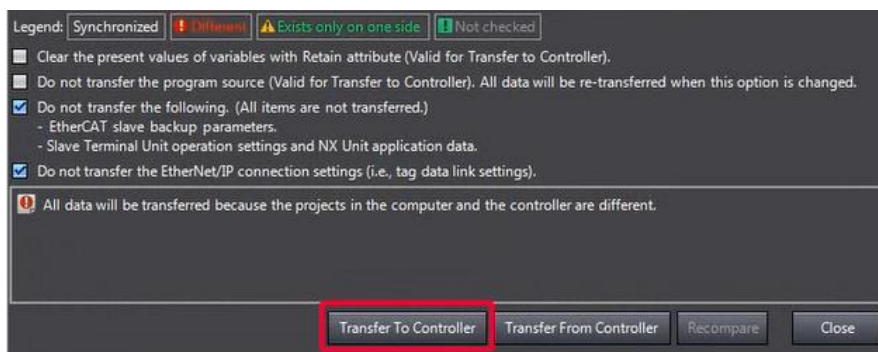

13. **Download the safety application.**
Select *new_SafetyCPU0* from the list.

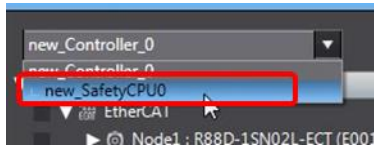

Click the **PROGRAM Mode** Button to switch to PROGRAM mode.

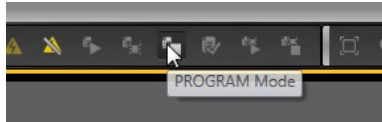

Click the **DEBUG Mode** Button to enter DEBUG mode.

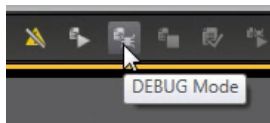

Click the **Start Debugging** Button to start DEBUG mode.

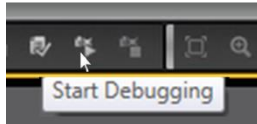

Click the **Safety Validation** Button.



The safety application is now ready to run.

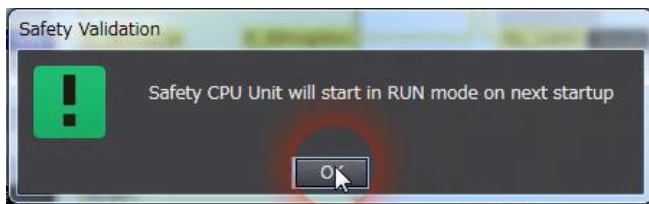

Click the **Run** Button.



14. **The FSoE communications are now established.**

The FS indicator is lit in green.

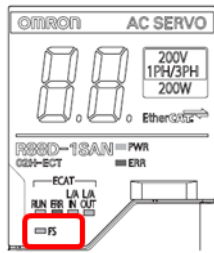

FS	Displays FSoE communications status.	Green	ON	FSoE slave connection established
			Flashing	FSoE slave connection establishment in progress
		Red	Flashing	Safety Parameter Error, Safety Communications Timeout, or other errors
		--	OFF	The safety functions are disabled by FSoE, the power is not supplied, or a fatal error including Self-diagnosis Error

■ **Checking Operation of the STO Function**

■ **Checking operation of the STO function using the Emergency Stop Pushbutton Switch**

1. **Press the safety rest button.**



2. **Press the Emergency Stop Pushbutton Switch.**



Check that the 7-segment LED display shows 'st'.

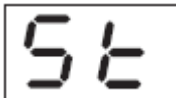





3. **Release the Emergency Stop Pushbutton Switch and press the safety rest button.**



Check that STO is released and the 7-segment LED display shows '--'.



■ **Checking operation of STO function using Safety-door Switch**

1.	<p>Press the safety rest button.</p> 
2.	<p>Open the guard with the Safety-door Switch.</p>  <p>Check that the 7-segment LED display shows 'st'.</p> 
3.	<p>Close the guard and press the safety reset switch.</p>  <p>Check that STO is released and the 7-segment LED display shows '--'.</p> 

3.4. Motor, ABS Encoder and I/O Setup

■ Quick Parameter Setup and I/O Monitor Wizard

1. Right-click the Servo Drive and select *Setup and Tuning* from the menu.

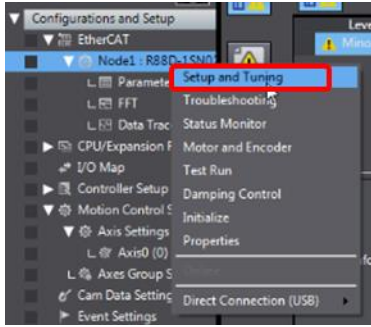
2. Click the *Quick Parameter Setup and I/O Monitor* Button.

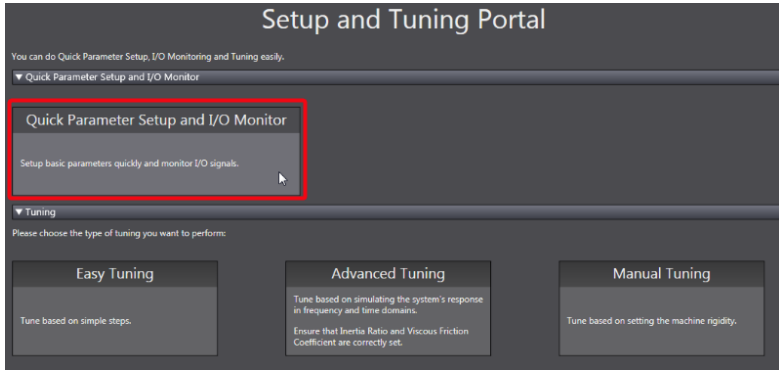
3. Select whether or not an OMRON Controller is connected.



When using I/O features of the Servo Drive in the motion control (MC) function module of the Sysmac Controller, select *Use* for the recommended settings. (Related inputs: IN2: POT, IN3: NOT, IN4: DEC, IN7: EXT1, IN8: EXT2, How to Use Absolute Encoder: Use as absolute encoder but ignore multi-rotation counter overflow)
4. Selects the operating method for the absolute encoder.



All 1S-series Servomotors have an absolute encoder, and it can be used as an incremental encoder if needed. When the Sysmac Controller is used, it is recommended to keep the default value (as described in step 3).

5. **Set up the absolute encoder (if required).**

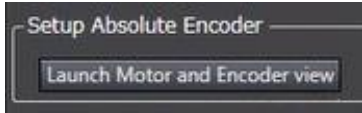

Use this function when clearing the multiple rotation data or when replacing a Servomotor in the actual machine.

Resetting multiple rotation data

Click the **Clear system** Button.

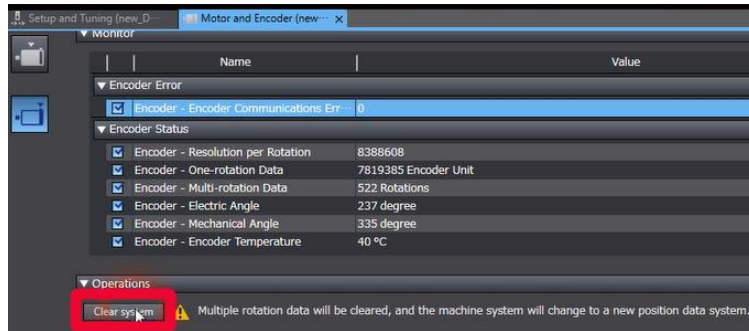

The following message appears: *Restart the drive to complete the operation.*

Click the **Yes** Button.

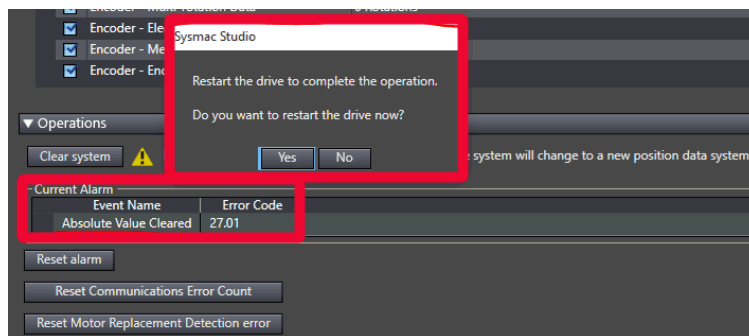

Multiple rotation data of the encoder has been cleared.

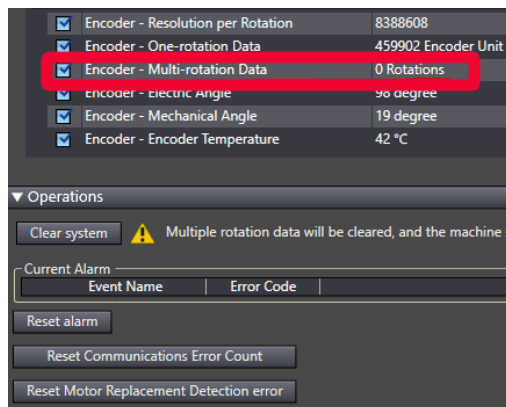

6. **Select the motor rotation direction and transfer the settings to the Servo Drive.**

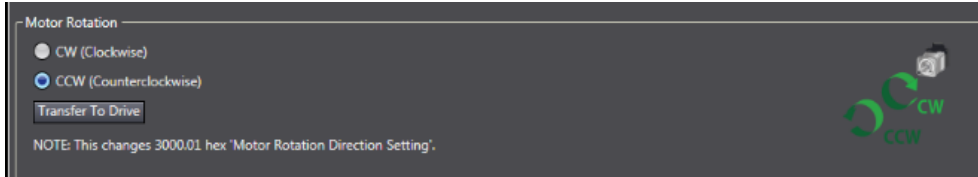

7. **Perform a test run to check the behavior of the Servomotor.**
Click the **Apply** Button in the Test Run tab page and then click the **Servo ON** Button to start the test run.

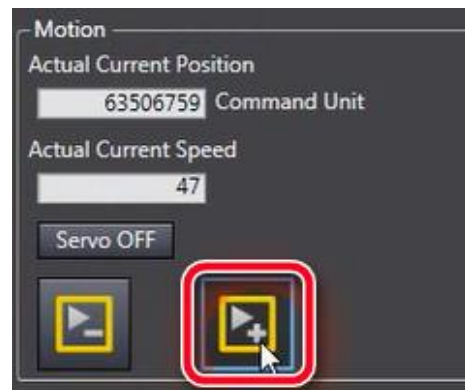
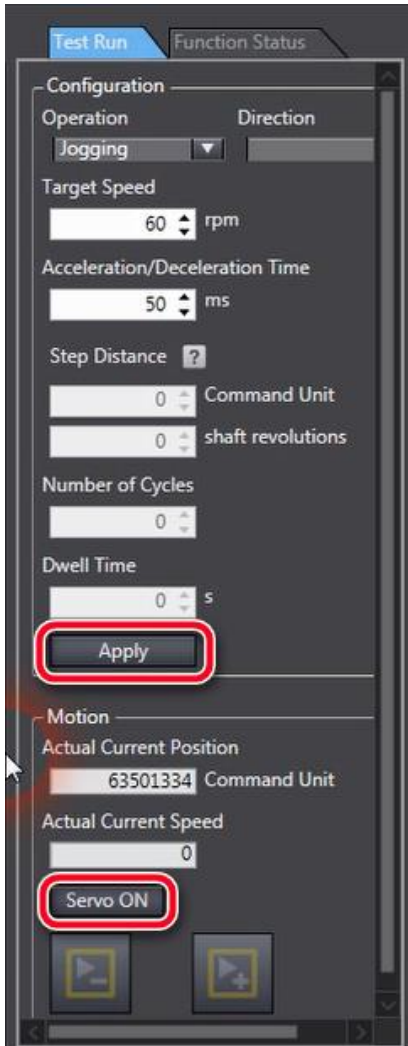

Note: When the Error Stop Input (ESTP) (Error No. 87.00) occurs, check wiring connection or turn OFF the Error Stop Input (IN1) as explained in the next step.

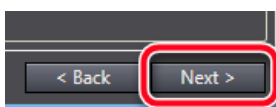

Click the **Next** Button.

8. **Set input signals and transfer the settings to the Servo Drive. Perform a test run to confirm that the settings are correct.**

The Error Stop Input (ESTP) is ON by default. Turn it OFF as follows if necessary. When ESTP is ON, the Error No. 87.00 is displayed on the Servo Drive.

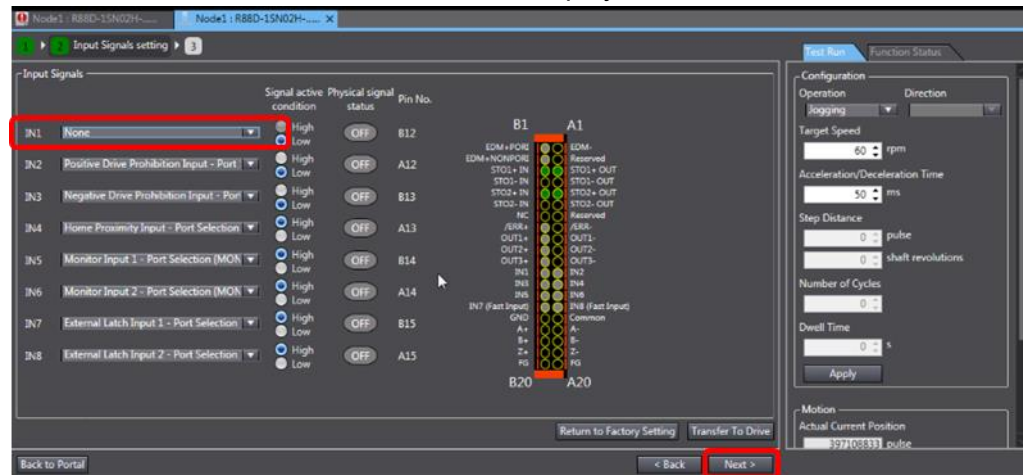

9. **Set output signals if necessary and transfer the settings to the Servo Drive. Perform a test run to confirm that the settings are correct.**

10. **Click the *Finish* Button.**



3.5. Easy Tuning for Gain Adjustment

Easy Tuning

Use the following procedure to perform adjustment. It is recommended to perform Easy Tuning first.

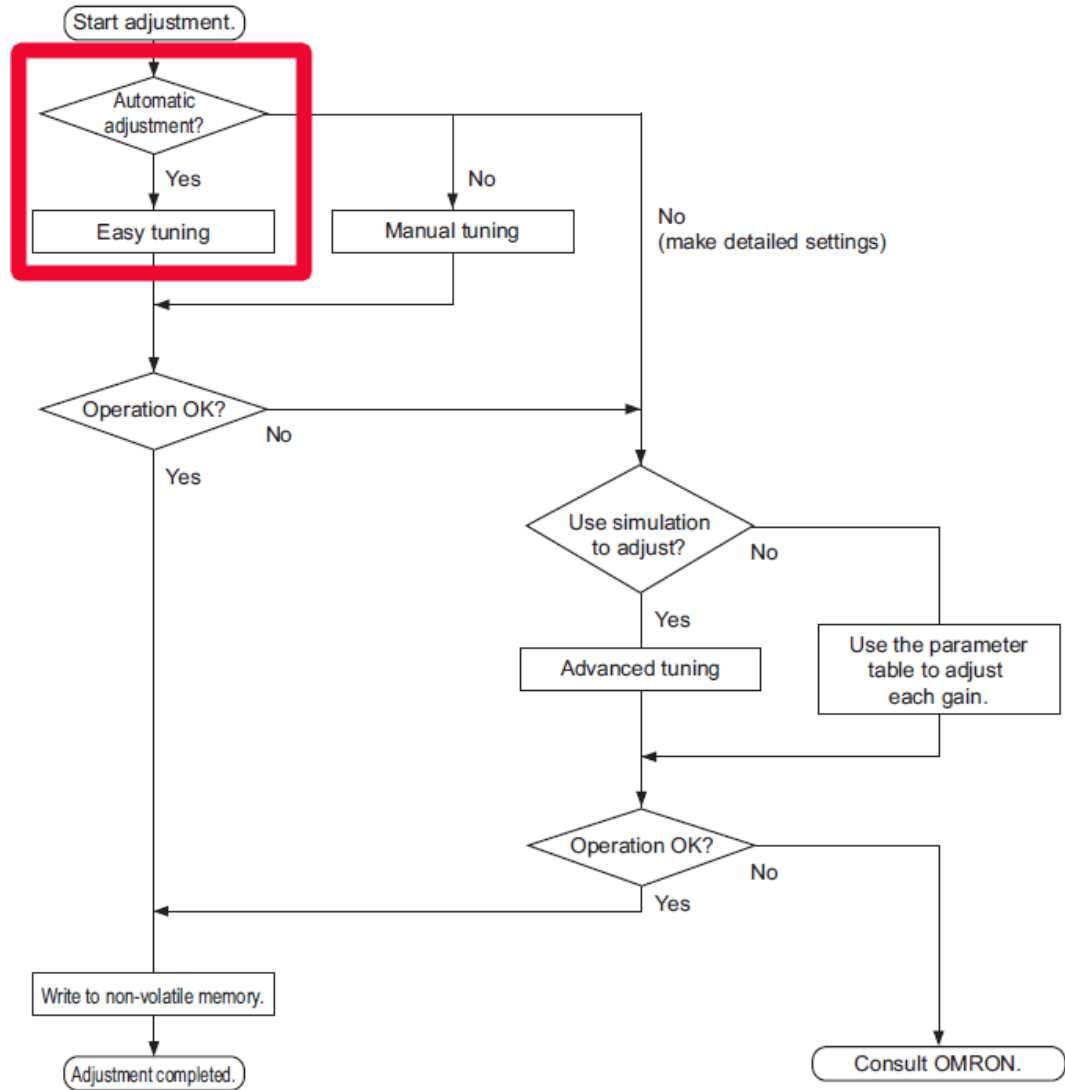

1. Right-click the Servo Drive and select **Setup and Tuning** from the menu.

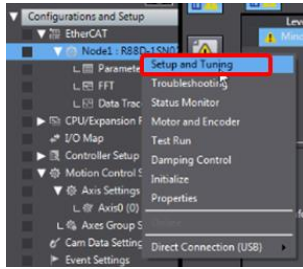

2. Click the **Easy Tuning** Button.

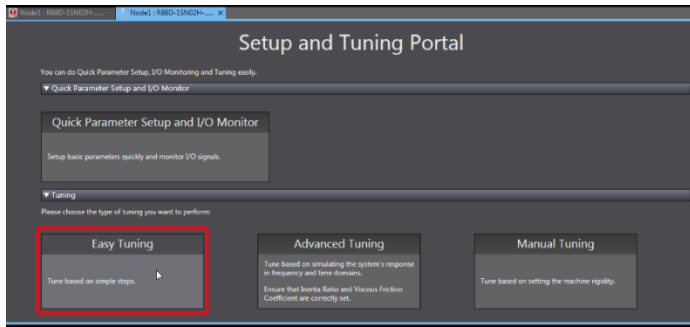

3. Select **Simple** for the tuning method and click the **Next** Button.

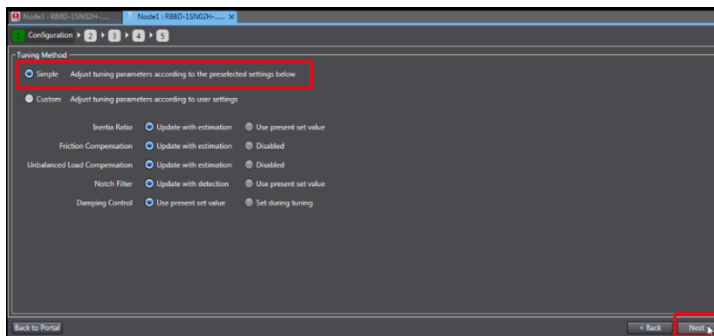

4. **Profile and Criteria**
Set the motion profile generator.

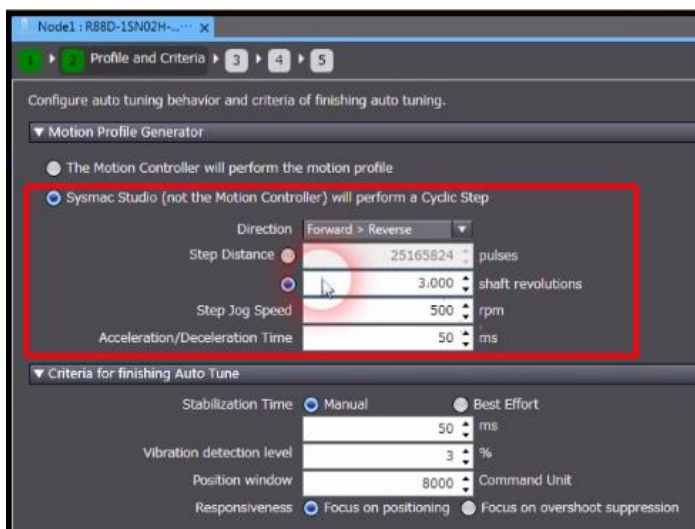

5. **Set the criteria for finishing auto tuning.**

Click the **Next** Button.

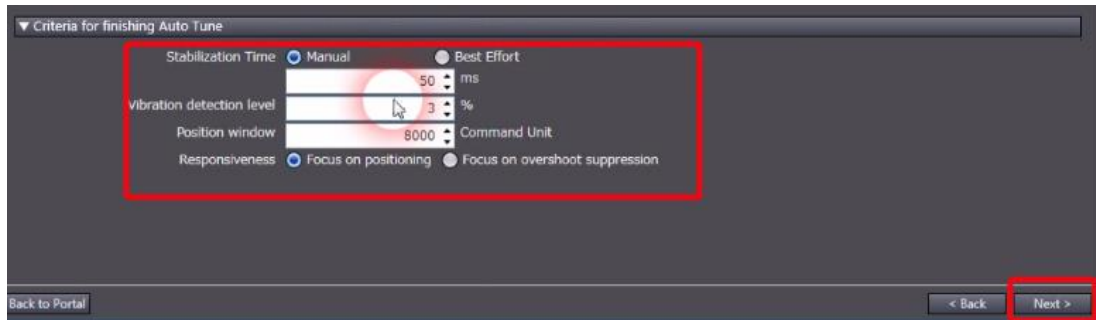

- When you select *Manual* for stabilization time, gain will be increased gradually until the stabilization time reaches the specified time. Specify the following error for the position window to determine that the positioning is completed. If a vibration above the vibration detection level is detected during tuning, an adjustment failure will occur.
- When you select *Best Effort* for the stabilization time, gain will be increased gradually so that the vibration does not exceed the vibration detection level. Set the vibration detection level so that the machine does not vibrate. The lower the vibration detection level, the less likely it is to generate vibration, but the gain is less likely to increase.

6. **Click the Start Button.**

Be careful because the Servomotor will start running.

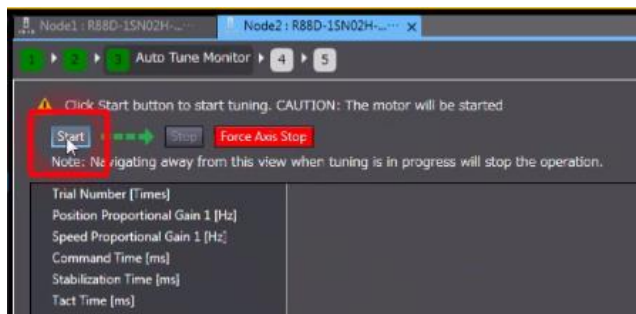

Easy Tuning has been completed.



Click the **Next** Button.

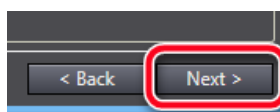

7. Click the **Start Trace Button**. The Servomotor will run, and the traced data will be displayed in the graph area.

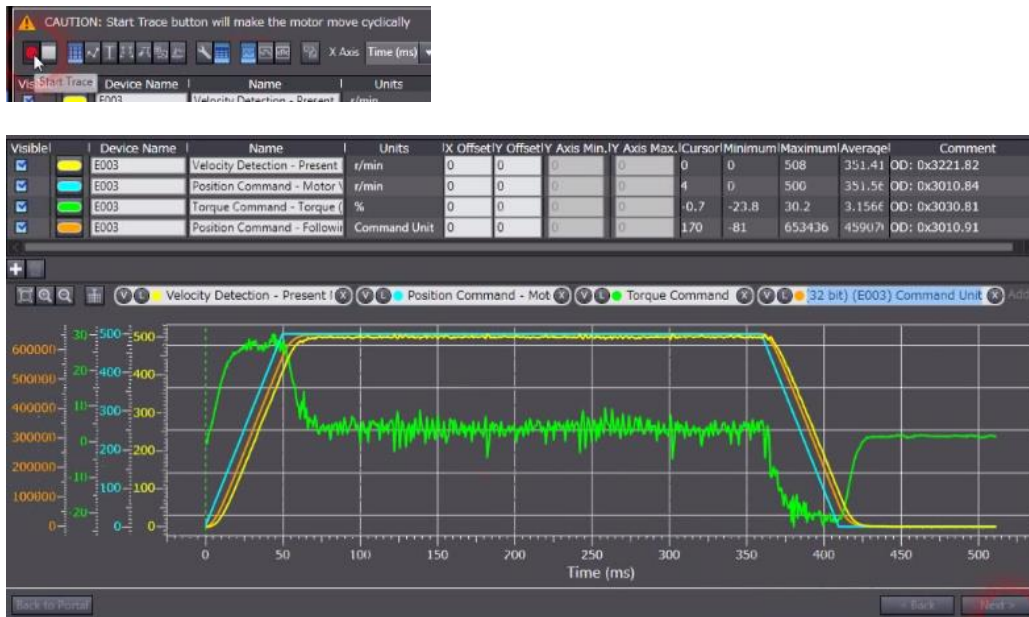

Click the **Next Button**.

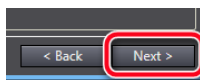

8. Check the tuning results of the gain parameters.
Click the **Save to EEPROM Button** to save the gain parameters.

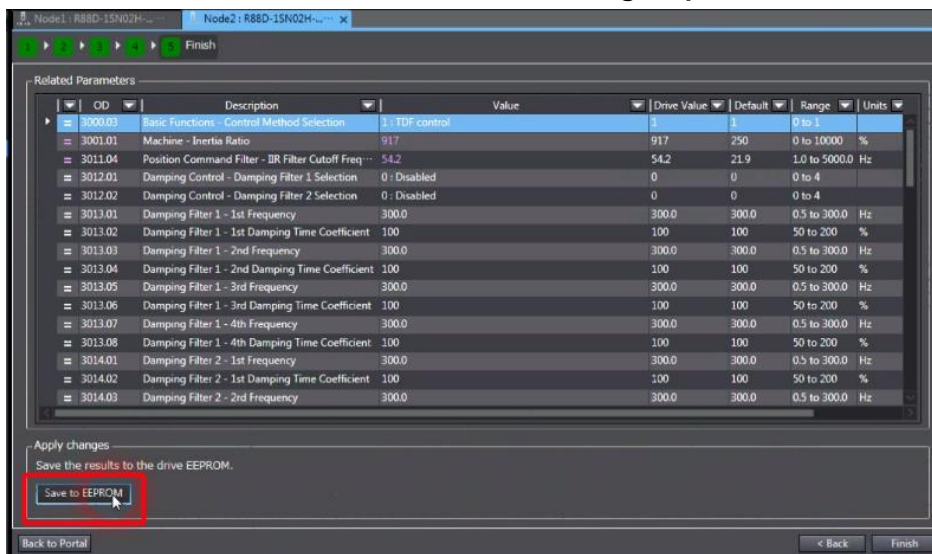

Click the **Finish Button**.

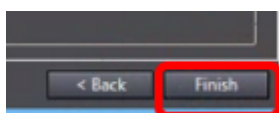

3.6. Creating a Motor Control Program

■ Creating a Standard Program

1. Open the I/O Map and create a device variable.

Port	Variable name
STO command active for R88D-1SAN02H-ECT	E_Axis0_STO_command_active

Position	Description	R/W	Data Type	Variable	Variable Comment	Variable Type
Controlword	Controlword	W	WORD			
Target position	Target position	W	DINT			
Target velocity	Target velocity	W	DINT			
Target torque	Target torque	W	INT			
Modes of operation	Modes of operation	W	SINT			
Touch probe function	Touch probe function	W	WORD			
Max profile velocity	Max profile velocity	W	UDINT			
Touch probe pos2_pos valu	Touch probe pos2_pos valu	R	DINT			
Digital inputs	Digital inputs	R	DWORD			
Mirror Safety controlword	Mirror Safety controlword	R	UINT			
Mirror Safety statusword	Mirror Safety statusword	R	UINT			
STO command active	Mirror Safety Statusword 0	R	BOOL	E_Axis0_STO_command_active		Global Variables

2. Create the following code:

1. The Servo is turned ON or OFF.

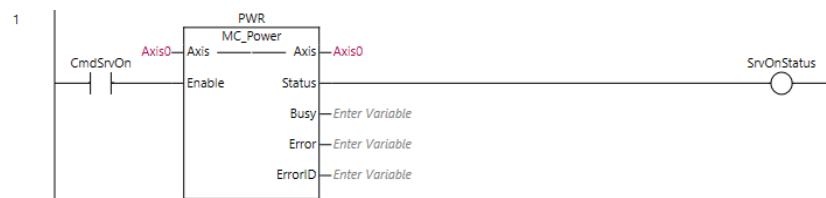

2. The Servomotor is run.

Set the velocity in the command unit specified in the *Setting an Axis*.

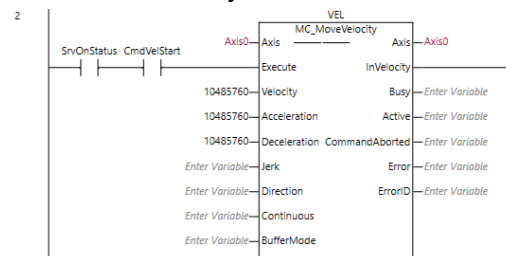

3. The Servomotor is stopped.

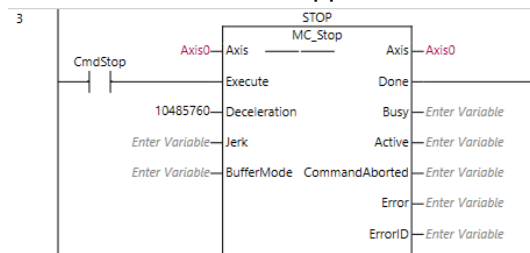

4. The errors of the Servo Drive are reset.

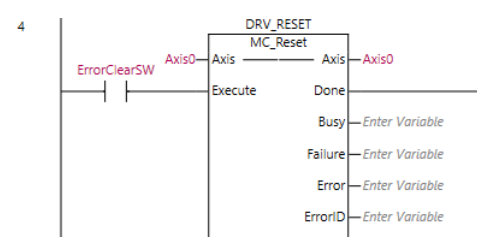

5. The errors of the standard controller are reset.

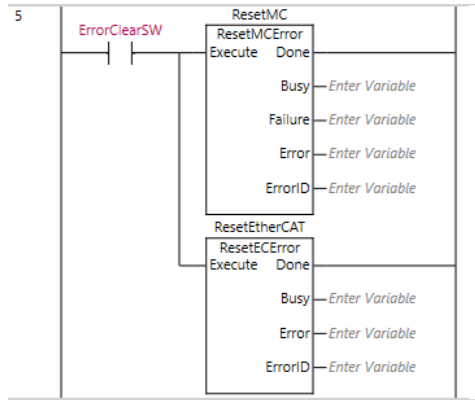

6. When the Servo Drive goes into the STO state, the Servo ON command and the motor start command are turned OFF.

```

5
1 | if E_Axis0_STO_command_active =TRUE THEN
2 |   CmdSrvOn:=FALSE;
3 |   CmdVelStart:=FALSE;
4 | END_IF;

```

3. **Transfer to the standard controller.**

Click the **Transfer To Controller** Button.

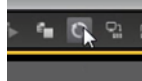

Transfer to the standard controller.

Legend: Synchronized Different Exists only on one side Not checked

- Clear the present values of variables with Retain attribute (Valid for Transfer to Controller).
- Do not transfer the program source (Valid for Transfer to Controller). All data will be re-transferred when this option is changed.
- Do not transfer the following. (All items are not transferred.)
 - EtherCAT slave backup parameters.
 - Slave Terminal Unit operation settings and NX Unit application data.
- Do not transfer the EtherNet/IP connection settings (i.e., tag data link settings).

! All data will be transferred because the projects in the computer and the controller are different.

■ Checking Operation

1. Press the safety rest button.
2. Double-click *Section0* to display the section.
3. Right-click *CmdSrvOn* and select *Set/Reset – Set*.

Check that the 7-segment LED display shows 'oE.'
4. Right-click *CmdVelStart* and select *Set/Reset – Set*.

Check that the Servomotor rotates at about 600 r/min.

5. **Press the Emergency Stop Pushbutton Switch.**



Check that the 7-segment LED display shows 'st'.



6. **Release the Emergency Stop Pushbutton Switch and press the safety rest button.**



Check that STO is released and the 7-segment LED display shows '--'.



4. Adding a Safety Function

This section describes how to add a safety function to the servo system built in 3. *Performing Setup*. Refer to the section of the safety function to add.

4.1. Adding the Safe Brake Control (SBC) Function to the STO Function

This section describes how to add the SBC function to the project created in 3. *Performing Setup*. The SBC function is used to interlock it with the Brake Interlock Output (BKIR).

■ Changes in System Configuration

Change the Servomotor to a motor with a brake.

NX-series NX1 CPU Unit

Additional I/O power supply

Digital Input Unit

NX-series Safety CPU Unit

NX-series Safety Input Unit

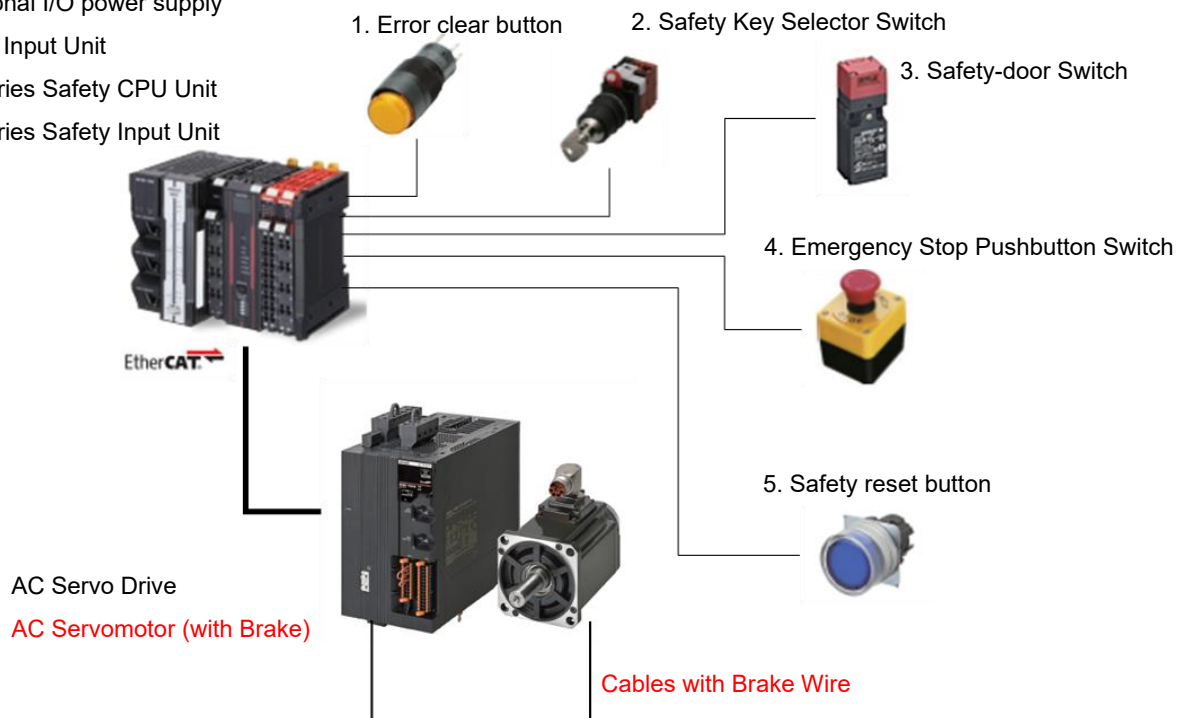

Device name	Model	Manual name
AC Servomotor (with Brake)	R88M-1A[]-B[]	1S-series with Built-in EtherCAT Communications and Safety Functionality User's Manual (Cat. No. I621)

■ Changes in Wiring

1. When you use the SBC function, plug the brake cable into the Servo Drive. (CN15)

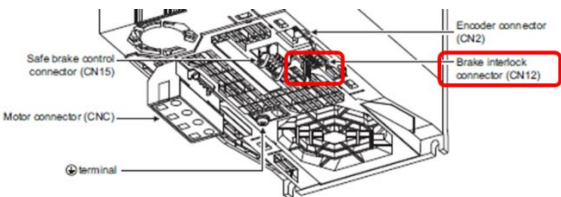

Encoder connector (CN2)
Brake interlock connector (CN12)
Safe brake control connector (CN15)
Motor connector (CNC)
terminal

Pin No.	Symbol	Signal name	Pin No.	Symbol	Signal name
1	SBC PS	24-V power supply for SBC (+)	5	SBC CM	24-V power supply for SBC (-)
2	SBC PS	24-V power supply for SBC (+)	6	SBC RFB	SBC relay feedback input
3	S1+	SBC1+	7	S1-	SBC1-
4	S2+	SBC2+	8	S2-	SBC2-

● Connector for CN15 (8 Pins)

Model	Manufacturer	Omron model
DFMC1.54-5T-3.5-LRBK	PHOENIX CONTACT	RS8K-CN102S

Applicable wire: AWG 24 to 16 (Ø: 0.2 to 1.5 mm) (Strip length of the wire insulating cover: 10 mm)



■ Changes in Drive Parameters

1. Set Drive parameters.
In this guide, set them as follows.

Name	Object	Value	Unit
Brake Interlock Output	4610-01 hex	1: Enabled	-
Timeout at Servo OFF	4610-02 hex	500	ms
Threshold Speed at Servo OFF	4610-03 hex	30	r/min
Hardware Delay Time	4610-04 hex	0	ms
External Brake Interlock Output	4663-01 hex	SBC Output	-

= 4610.01	Brake Interlock Output - Enable	1 : Enabled
= 4610.02	Brake Interlock Output - Timeout at Servo OFF	500
= 4610.03	Brake Interlock Output - Threshold Speed at Ser...	30
= 4610.04	Brake Interlock Output - Hardware Delay Time	0
= 4663.01	External Brake Interlock Output - Port Selection	2147483648 : SBC Output
= 4663.02	External Brake Interlock Output - Logic Selection	0 : Positive logic (NO contact)

The operation of the servo system set up in this section is explained below.

1. When the error clear button is pressed, the errors of the standard controller and Servo Drive are reset.
2. When the guard with the Safety-door Switch is opened, the motor torque is turned OFF. After the torque is turned OFF, the Servo Drive activates the SBC function to monitor the brake signal.
3. When the Emergency Stop Pushbutton Switch is pressed, the motor torque is turned OFF. After the torque is turned OFF, the Servo Drive activates the SBC function to monitor the brake signal.
4. When the safety reset button is pressed, the STO status is reset.

Input device	State	Operation
1. Error clear button	ON	Enable error reset command
	OFF	Disable error reset command
2. Safety-door Switch	Open	Enable STO command
	Close	Disable STO command
3. Emergency Stop Pushbutton Switch	ON	Enable STO command
	OFF	Disable STO command
4. Safety reset button	ON	Enable reset STO status command
	OFF	Disable reset STO status command

■ Operation of SBC Function Interlocked with Motion Control and STO Function

1. When the Servo ON command is enabled, the Servo Drive turns ON the Servo.
2. When an operation command is enabled, the command velocity to the Servomotor is set to 600 r/min.
3. When the STO function is executed, the Servo Drive shifts to the STO state and turns OFF torque. After the torque is turned OFF, the Servo Drive activates the SBC function.

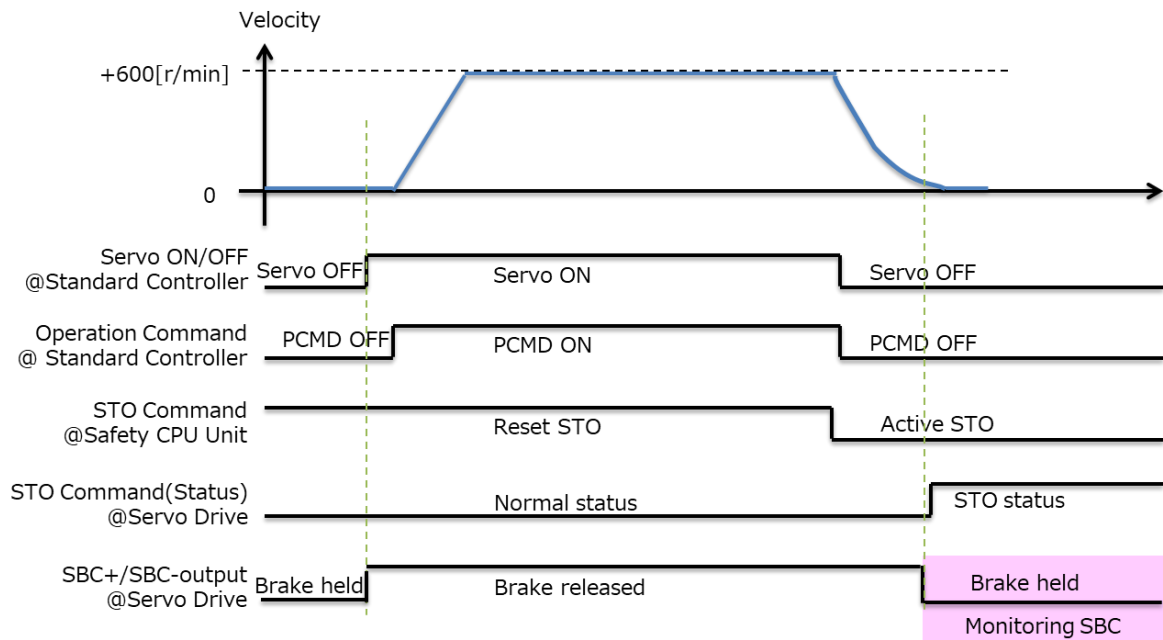

■ Setting the Safety Controller

1. Select *new_SafetyCPU0* from the list.

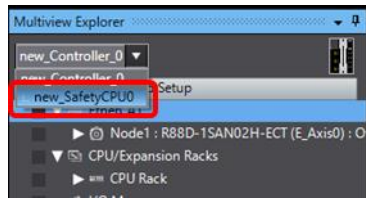

2. Double-click *SRA Parameters* and click the *Safety Function Assignment Settings* Button.

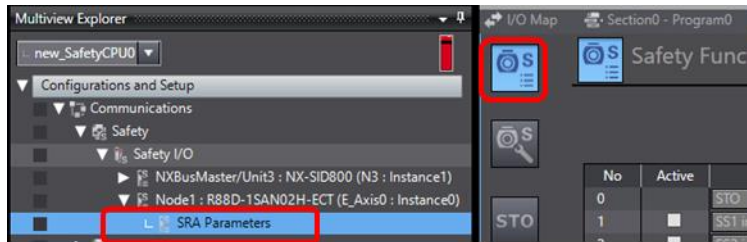

3. Deactivate safety functions except for the **STO** function.
Clear the selections of the *Active* Check Boxes for SS1 instance1, SS2 instance1, SOS instance1, SDIp, and SDIn to deactivate the unused safety functions.

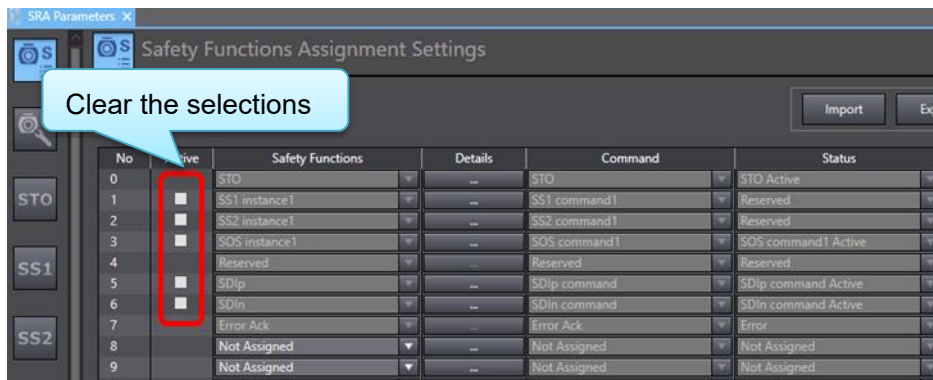

4. Click the  Button to display the **STO Detailed Settings** view.
You can also use  the  Button to display the STO Detailed Settings view.

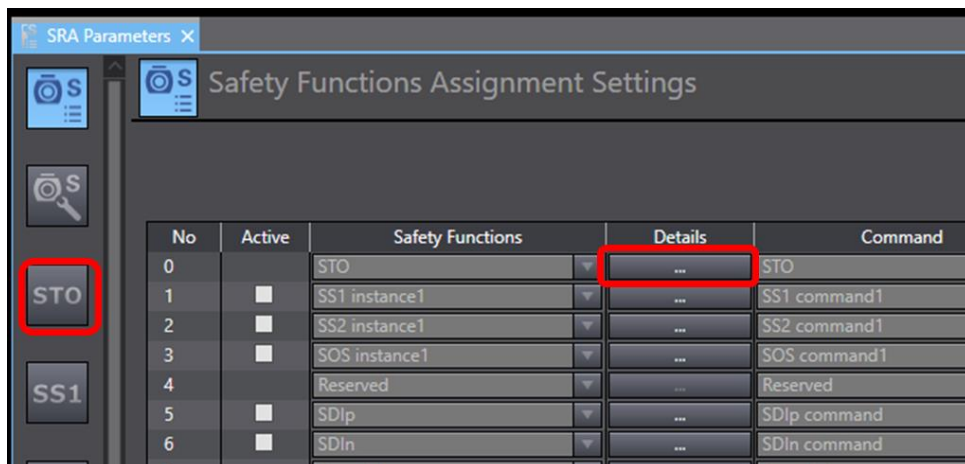



5. **Set STO parameters.**

In this guide, set them as follows.

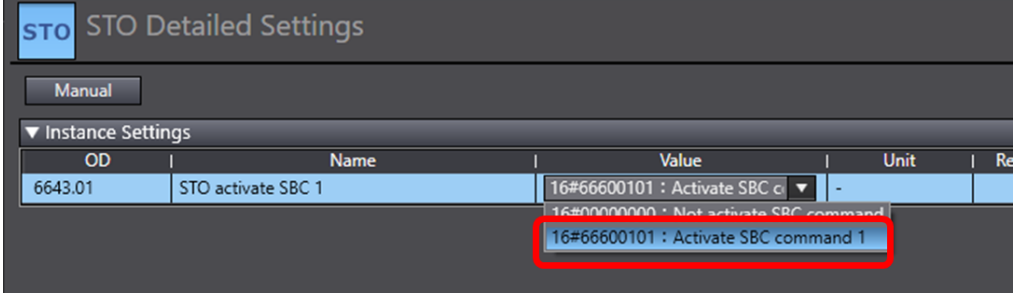
Name	Value	Unit
STO activate SBC 1	Activate SBC command 1	-



6. Click the  **Button to display the SBC Detailed Settings view.**



7. **Set SBC parameters.**

In this guide, set them as follows.

Name	Value	Unit
SBC brake time delay	200	ms
Safety Relay Activate	0: Deactivate (Not Use)	-
Safety Relay OFF Delay Time 1	30	ms
Safety Relay OFF Delay Time 2	30	ms

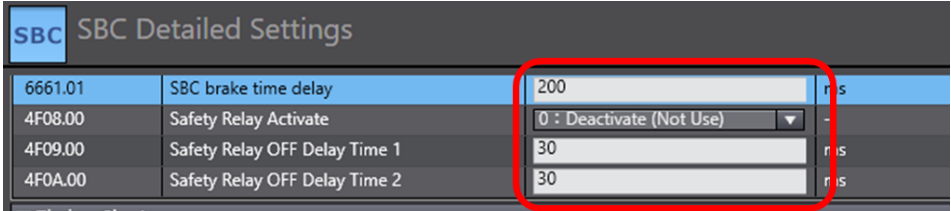
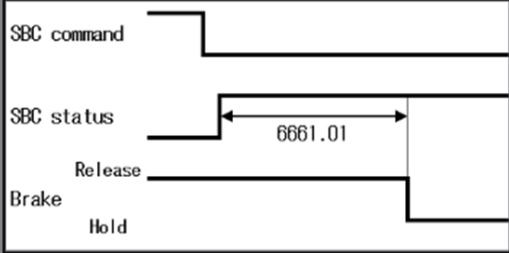
8. Check that the created program is the same as shown below.
 Device variables and safety programs are the same as those of the STO function.

* For further details, refer to *Creating a Safety Program in 3.3 Sysmac Studio Project Creation.*



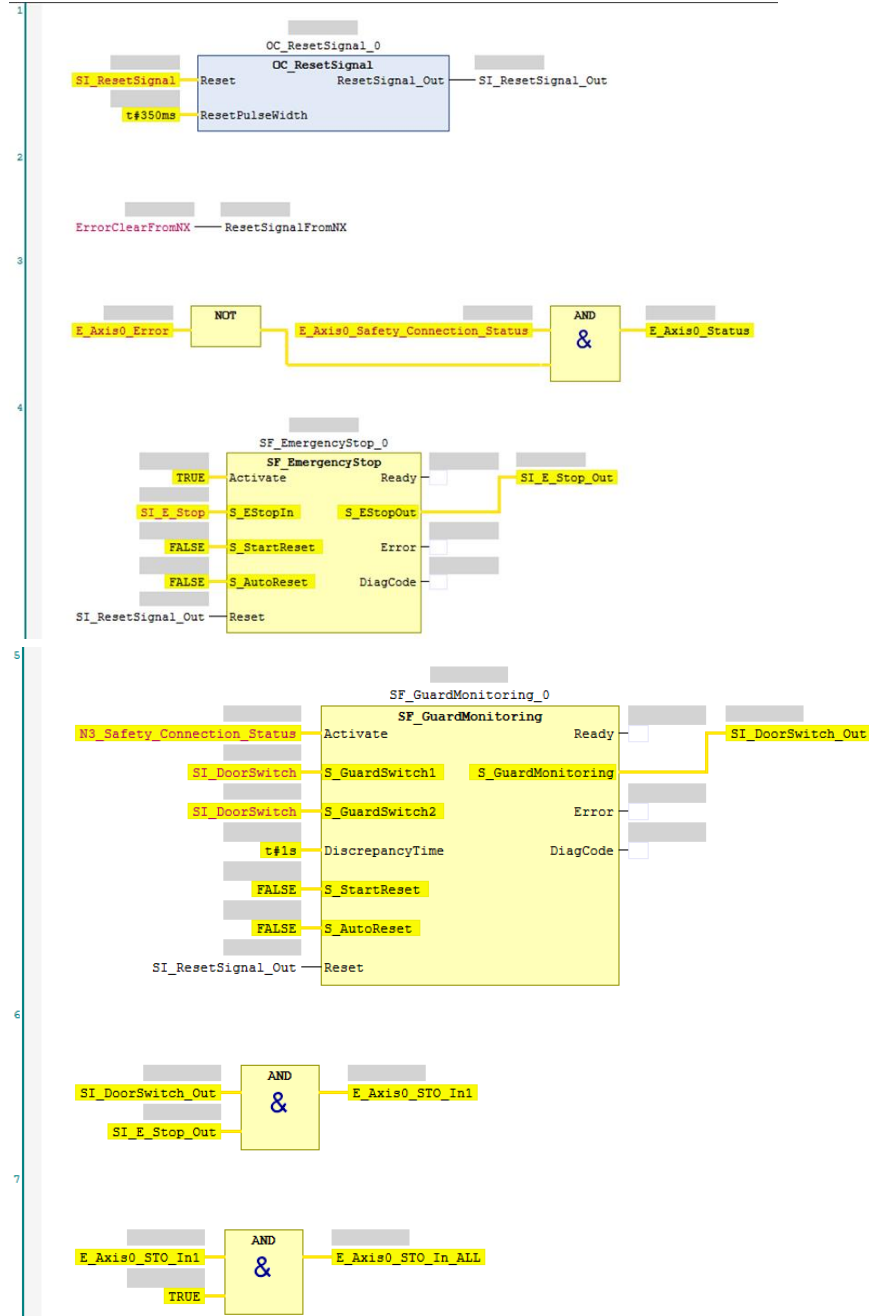

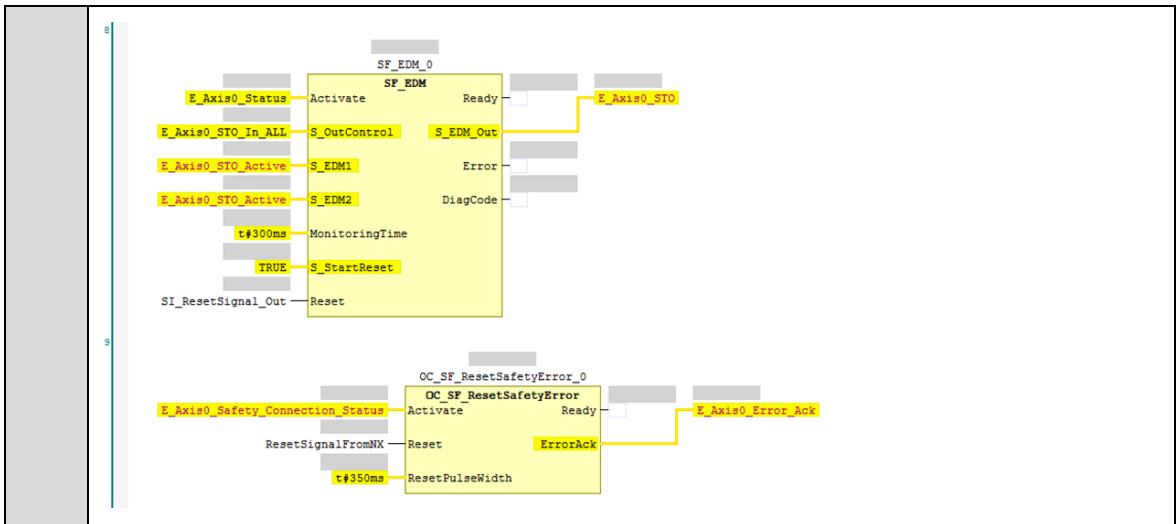
■ Setting the Standard Controller

1. The program is the same as that of the STO function. For further details, refer to 3.6 *Creating a Motor Control Program*. Confirm that the program is as follows.

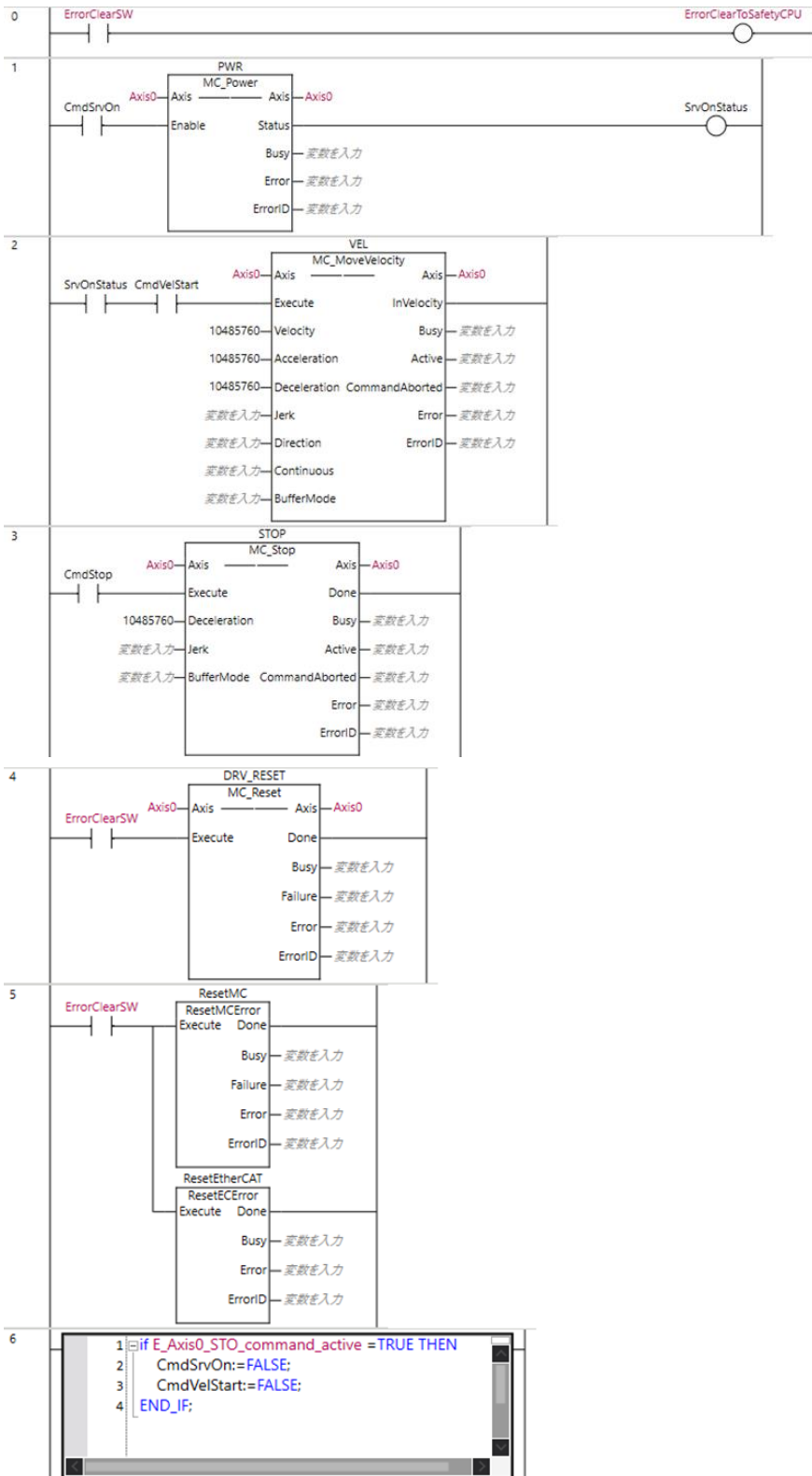

2. **Transfer to the standard controller.**

Select *new_Controller_0* from the list.

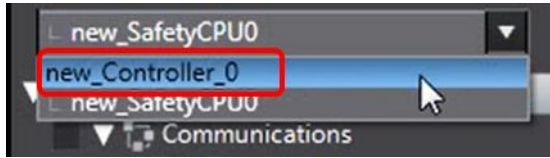

Connect to the standard controller.



Click the **Synchronization** Button to synchronize with the standard controller.



Transfer to the standard controller.

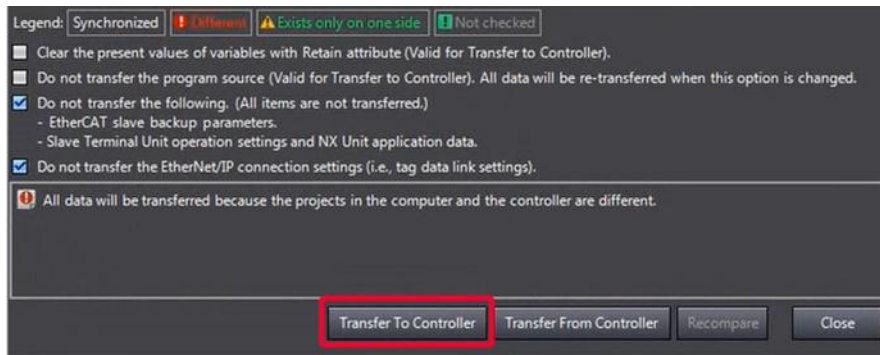

3. **Download the safety application.**

Select *new_SafetyCPU0* from the list.

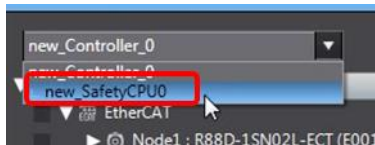

Click the **PROGRAM Mode** Button to switch to PROGRAM mode.

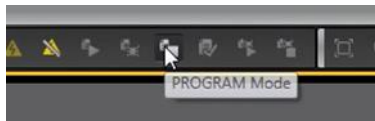

Click the **DEBUG Mode** Button to enter DEBUG mode.

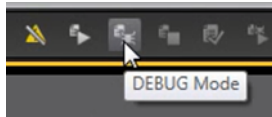

Click the **Start Debugging** Button to start DEBUG mode.

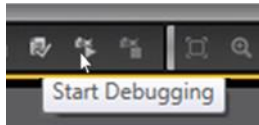

Click the **Safety Validation** Button.

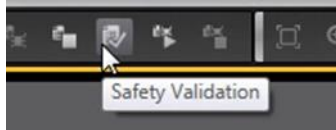

Click the **OK** Button.

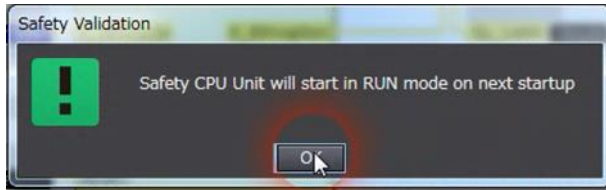

Click the **Run** Button.







4. **The FSoE communications are now established.**

The FS indicator is lit in green.



FS	Displays FSoE communications status.	Green	ON	FSoE slave connection established
			Flashing	FSoE slave connection establishment in progress
		Red	Flashing	Safety Parameter Error, Safety Communications Timeout, or other errors
		--	OFF	The safety functions are disabled by FSoE, the power is not supplied, or a fatal error including Self-diagnosis Error

■ **Checking Operation of the SBC Function Interlocked with the STO Function**

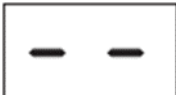
■ **Checking Operation of the SBC Function Using the Emergency Stop Pushbutton Switch**

1.	<p>Press the safety reset button.</p> 
2.	<p>Press the Emergency Stop Pushbutton Switch.</p>  <p>Check that STO is activated to apply the brake. (Make sure that no SBC stuck-at-high error is detected.) Check that the 7-segment LED display shows 'st'.</p> 
3.	<p>Release the Emergency Stop Pushbutton Switch and press the safety reset button.</p>  <p>Check that STO is released and the 7-segment LED display shows '--'.</p> 

■ **Checking Operation of SBC Function Using Safety-door Switch**

1.	<p>Press the safety reset button.</p> 
2.	<p>Open the guard with the Safety-door Switch.</p>  <p>Check that STO is activated to apply the brake. Check that the 7-segment LED display shows 'st'.</p> 

3.

Close the guard and press the safety reset switch.



Check that STO is released and the 7-segment LED display shows '--'.



4.2. Adding the Safe Stop 1 (SS1) Function

This section describes how to add the SS1 function to the project created in 3. *Performing Setup*. It also describes the procedure for adding the SBC function to the SS1 function. The SBC function is used to interlock it with the Brake Interlock Output (BKIR).

Changes in System Configuration

Change the Servomotor to a motor with a brake.

NX-series NX1 CPU Unit

Additional I/O power supply

Digital Input Unit

NX-series Safety CPU Unit

NX-series Safety Input Unit

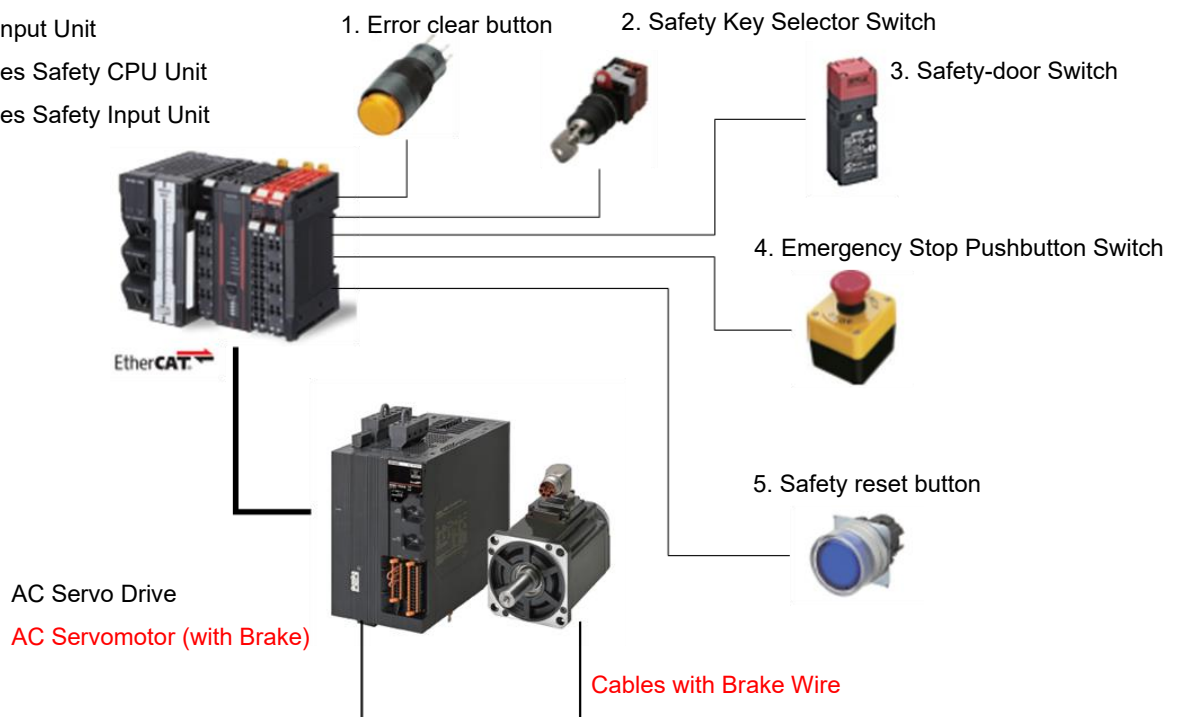

Device name	Model	Manual name
AC Servomotor (with Brake)	R88M-1A[]-B[]	1S-series with Built-in EtherCAT Communications and Safety Functionality User's Manual (Cat. No. I621)

Changes in Wiring

- When you use the SBC function, plug the brake cable into the Servo Drive. (CN15)

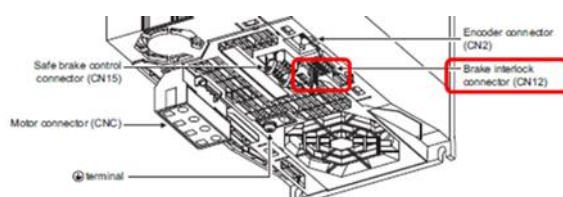

Pin No.	Symbol	Signal name	Pin No.	Symbol	Signal name
1	SBC PS	24-V power supply for SBC (+)	5	SBC CM	24-V power supply for SBC (-)
2	SBC PS	24-V power supply for SBC (+)	6	SBC RFB	SBC relay feedback input
3	S1+	SBC1+	7	S1	SBC1
4	S1+	SBC1+	8	S2	SBC2

Connector for CN15 (8 Pins)

Model	Manufacturer	Original Model
DFMC1.54-G7-3-S-LR3K	PHOENIX CONTACT	NSBA-CN15C2

Applicable wire: AWG 24 to 16 (0.2 to 1.5 mm²) (strip length of the wire insulating cover: 10 mm)



■ Changes in Drive Parameters

1. Set Drive parameters.

In this guide, set them as follows.

Name	Object	Value	Unit
Brake Interlock Output	4610-01 hex	1: Enabled	-
Timeout at Servo OFF	4610-02 hex	500	ms
Threshold Speed at Servo OFF	4610-03 hex	30	r/min
Hardware Delay Time	4610-04 hex	0	ms
External Brake Interlock Output	4663-01 hex	SBC Output	-

= 4610.01	Brake Interlock Output - Enable	1 : Enabled
= 4610.02	Brake Interlock Output - Timeout at Servo OFF	500
= 4610.03	Brake Interlock Output - Threshold Speed at Ser..	30
= 4610.04	Brake Interlock Output - Hardware Delay Time	0
= 4663.01	External Brake Interlock Output - Port Selection	2147483648 : SBC Output
= 4663.02	External Brake Interlock Output - Logic Selection	0 : Positive logic (NO contact)

The operation of the servo system set up in this section is explained below.

1. When the error clear button is pressed, the errors of the standard controller and Servo Drive are reset.
2. When the Safety Key Selector Switch is operated to switch to safety active mode, the standard controller lets the Servomotor decelerate to a stop.
The Servo Drive activates the STO function using the SS1 function to turn OFF the motor torque. After the torque is turned OFF, the Servo Drive activates the SBC function to monitor the brake signal.
3. When the Emergency Stop Pushbutton Switch is pressed, the motor torque is turned OFF. (If the Servo Drive activates the SBC function after the torque is turned OFF, you need to perform the setting procedure described in [4.1.](#))
4. When the safety reset button is pressed, the STO status is reset.

Input device	State	Operation
1. Error clear button	ON	Enable error reset command
	OFF	Disable error reset command
2. Safety Key Selector Switch	Normal operating mode	Run Servomotor at normal velocity.
	Safety active mode	Make Servomotor decelerate to a stop and activate STO function using SS1 function. After the torque is turned OFF, the Servo Drive activates the SBC function to monitor the brake signal.
3. Safety-door Switch	Open	SS1 function deactivated: Enable STO command SS1 function activated (during deceleration): Enable STO command SS1 function activated (after STO activation from SS1): Disable STO command
	Close	Disable STO command
4. Emergency Stop Pushbutton Switch	ON	Enable STO command
	OFF	Disable STO command
5. Safety reset button	ON	Enable reset STO status command
	OFF	Disable reset STO status command

■ Operation of SBC Function Interlocked with Motion Control and SS1 Function

1. When the Servo ON command is enabled, the Servo Drive turns ON the Servo.
2. When an operation command is enabled, the command velocity to the Servomotor is set to 600 r/min.
3. The standard controller lets the Servomotor decelerate to a stop.

When the SS1 function is executed, the Servo Drive shifts to the STO state after the wait time (SS1 time to STO 1) and turns OFF torque. After the torque is turned OFF, the Servo Drive activates the SBC function to monitor the brake signal.

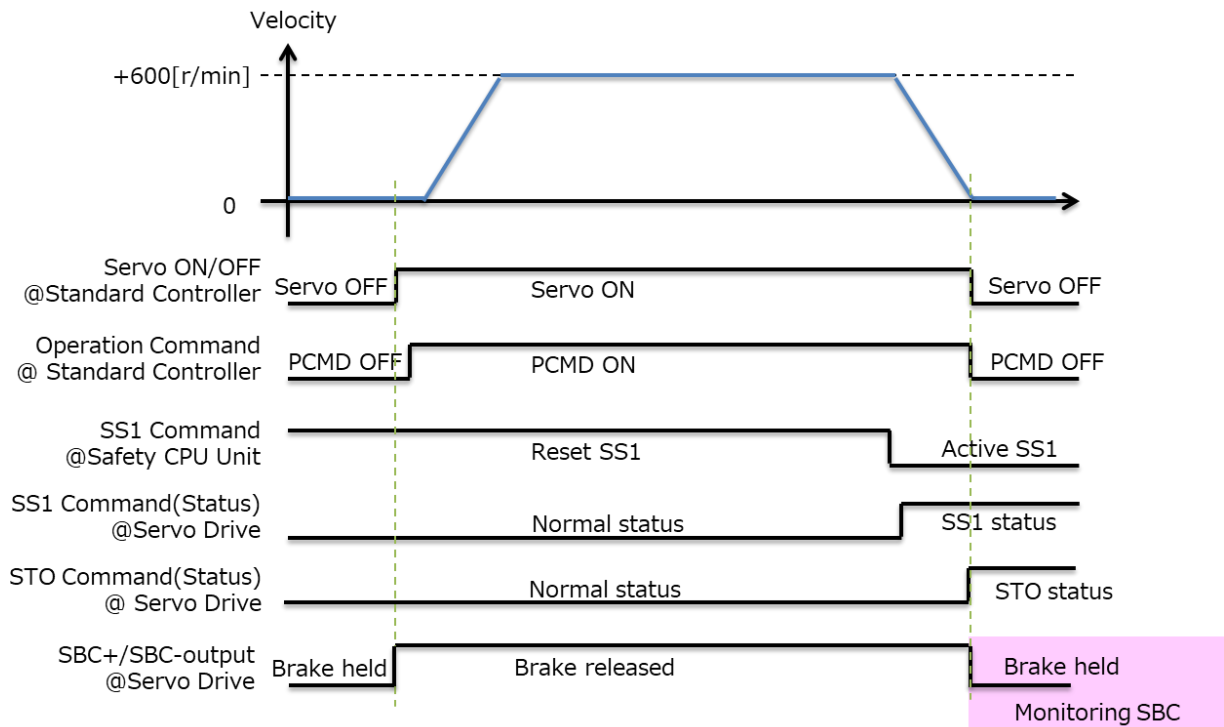



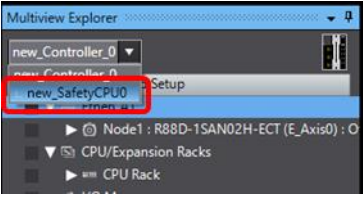

■ Setting the Safety Controller

1. Select *new_SafetyCPU0* from the list.

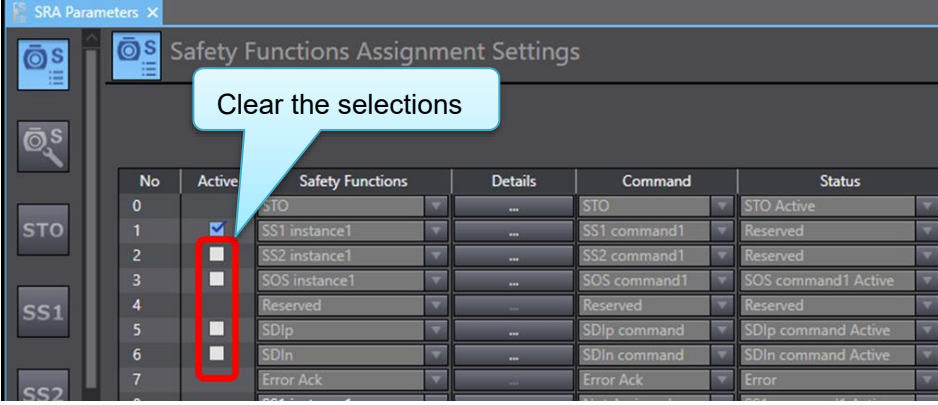
2. Double-click *SRA Parameters* and click the *Safety Function Assignment Settings* Button.

3. Deactivate safety functions except for the SS1 function.
Clear the selections of the *Active* Check Boxes for SS2 instance1, SOS instance1, SDIp, and SDIn to deactivate the unused safety functions.

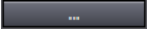

No	Active	Safety Functions	Details	Command	Status
0	<input type="checkbox"/>	STO	...	STO	STO Active
1	<input checked="" type="checkbox"/>	SS1 instance1	...	SS1 command1	Reserved
2	<input type="checkbox"/>	SS2 instance1	...	SS2 command1	Reserved
3	<input type="checkbox"/>	SOS instance1	...	SOS command1	SOS command1 Active
4	<input type="checkbox"/>	Reserved	...	Reserved	Reserved
5	<input type="checkbox"/>	SDIp	...	SDIp command	SDIp command Active
6	<input type="checkbox"/>	SDIn	...	SDIn command	SDIn command Active
7	<input type="checkbox"/>	Error Ack	...	Error Ack	Error
4. Click the  Button to display the **SS1 Detailed Settings** view.
You can also use  the  Button to display the **SS1 Detailed Settings** view.

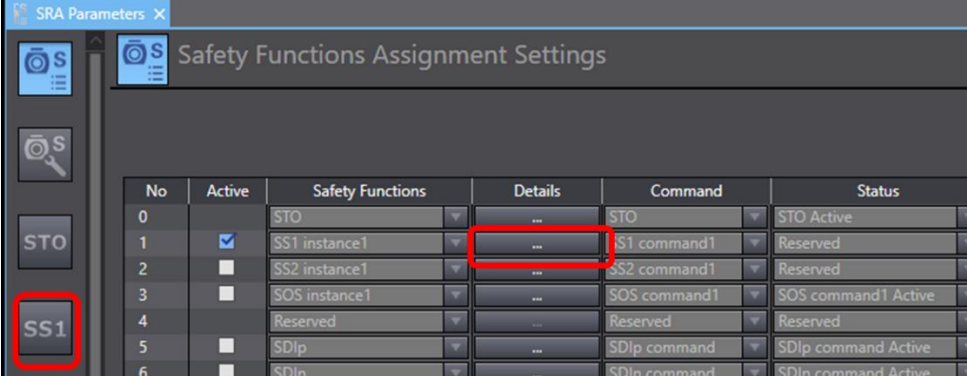

5. **Set SS1 parameters.**

In this guide, set them as follows.

Name	Value	Unit
SS1 time to STO 1	300	ms
SS1 velocity zero window 1	50	r/min
SS1 time for velocity zero 1	100	ms
SS1 activate SBC 1	Activate SBC command 1.	-

Note: Set times so that SS1 time for velocity zero 1 is less than or equal to SS1 time to STO 1.

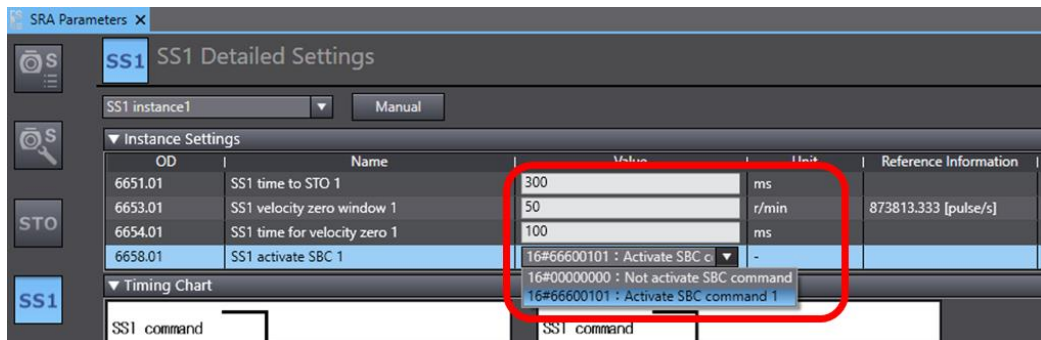

6. **Open the I/O Map and create device variables.**

Port	Variable name
SS1 command1 Active for R88D-1SAN02H-ECT	E_Axis0_SS1_command1_Active
SS1 command1 for R88D-1SAN02H-ECT	E_Axis0_SS1_command1

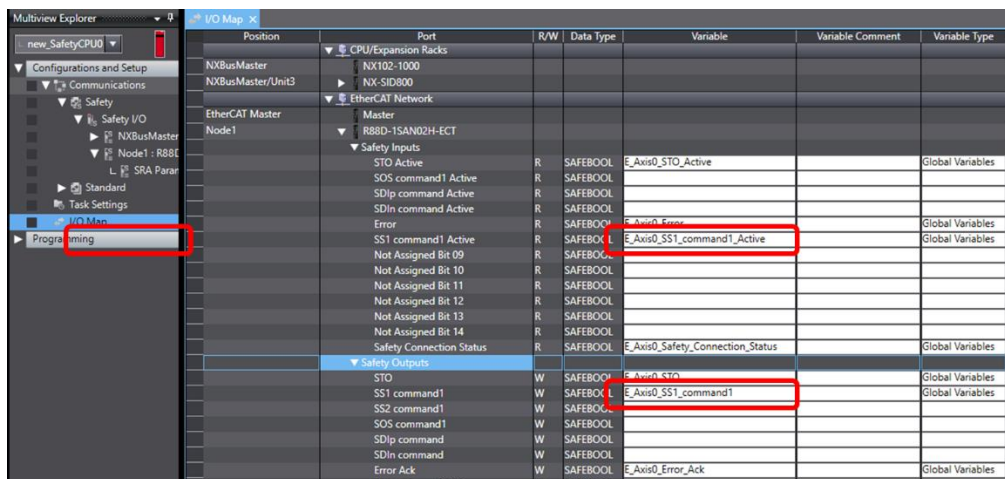

7. Create a safety program.
Add the following code to AutoProgram1.

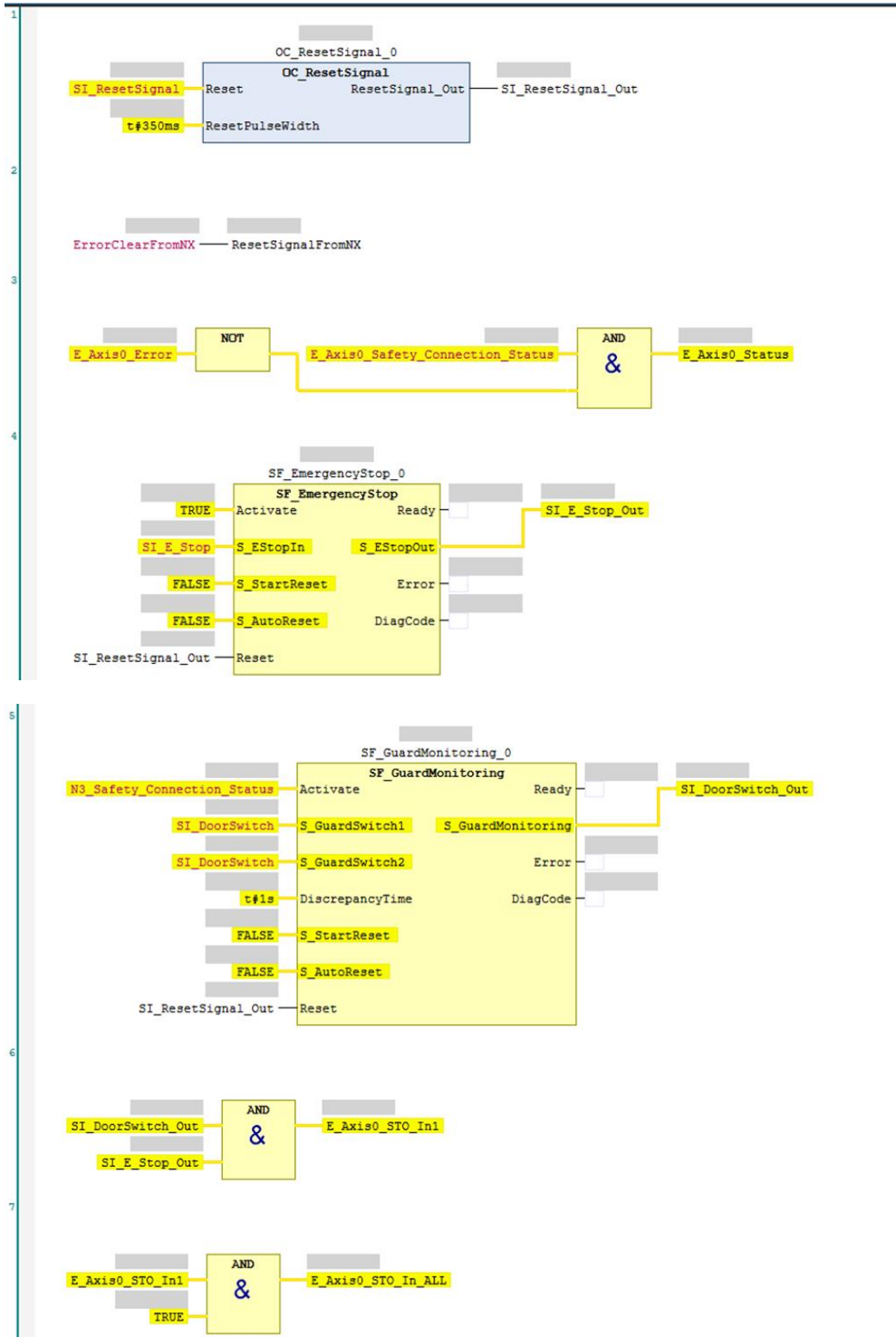

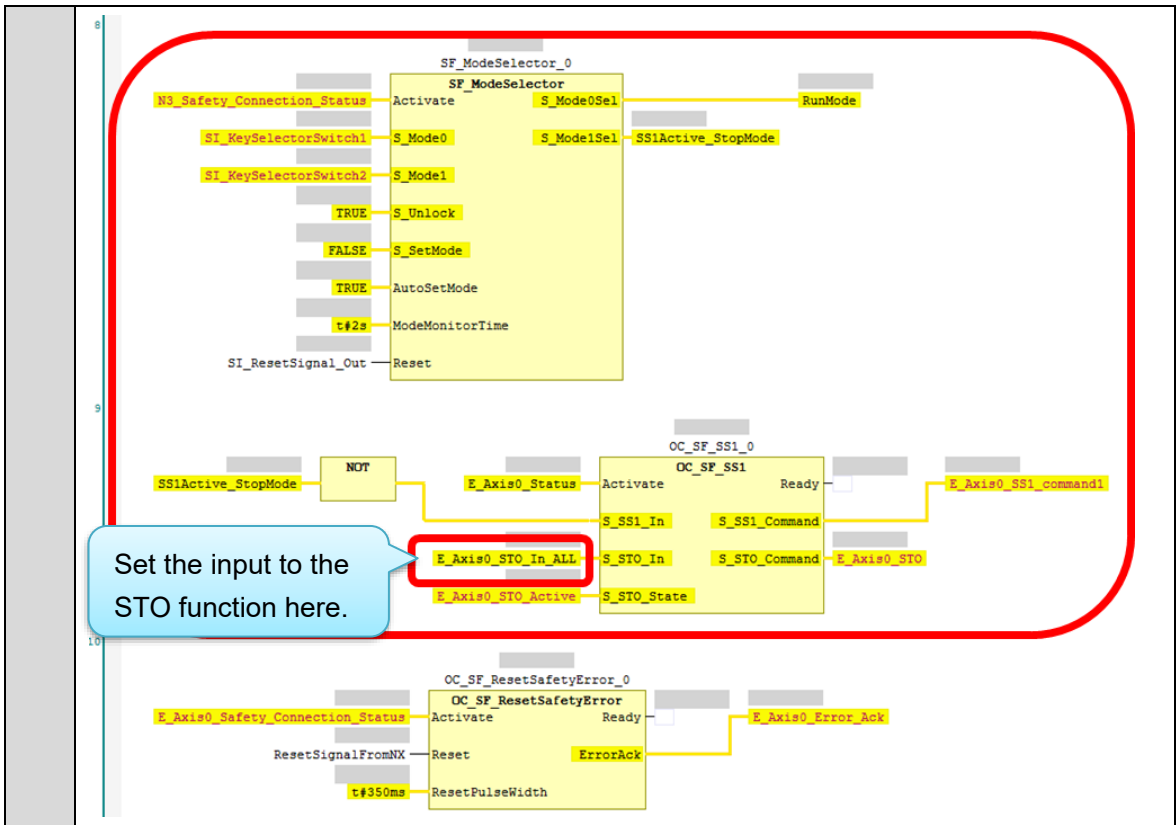

■ Setting the Standard Controller

1. Select *new_Controller_0* from the list.

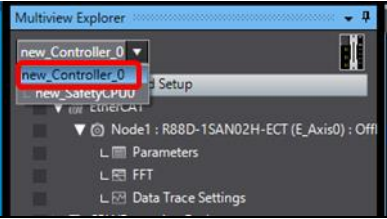

2. Double-click *I/O Map*.

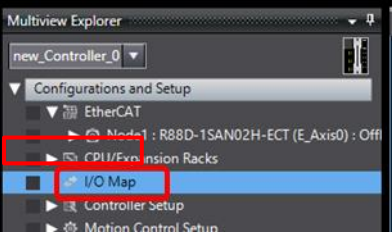

3. Create device variables.

Port	Variable name
SS1 command1 for R88D-1SAN02H-ECT	E_Axis0_SS1_command_1
SS1 command1 active for R88D-1SAN02H-ECT	E_Axis0_SS1_command_1_active

▼ Mirror Safety controlword	Mirror Safety controlword	R	UINT			
STO command	Mirror Safety Controlword	R	BOOL			
SS1 command 1	Mirror Safety Controlword	R	BOOL	E_Axis0_SS1_command_1		Global Variables
SS2 command 1	Mirror Safety Controlword	R	BOOL			
▼ Mirror Safety statusword	Mirror Safety statusword	R	UINT			
STO command active	Mirror Safety Statusword 0	R	BOOL	E_Axis0_STO_command_active		Global Variables
Mirror Safety Statusword 1	Mirror Safety Statusword 1	R	BOOL			
Mirror Safety Statusword 2	Mirror Safety Statusword 2	R	BOOL			
SOS command 1 active	Mirror Safety Statusword 3	R	BOOL			
Mirror Safety Statusword 4	Mirror Safety Statusword 4	R	BOOL			
SDI positive direction command active	Mirror Safety Statusword 5	R	BOOL			
SDI negative direction command active	Mirror Safety Statusword 6	R	BOOL			
error acknowledge active	Mirror Safety Statusword 7	R	BOOL			
SS1 command 1 active	Mirror Safety Statusword 8	R	BOOL	E_Axis0_SS1_command_1_active		Global Variables
Mirror Safety Statusword 9	Mirror Safety Statusword 9	R	BOOL			

4. **Create code for the standard program.**

Add the code to change the command velocity.

- When the SS1 function is active, reduce the command velocity to 0 r/min.

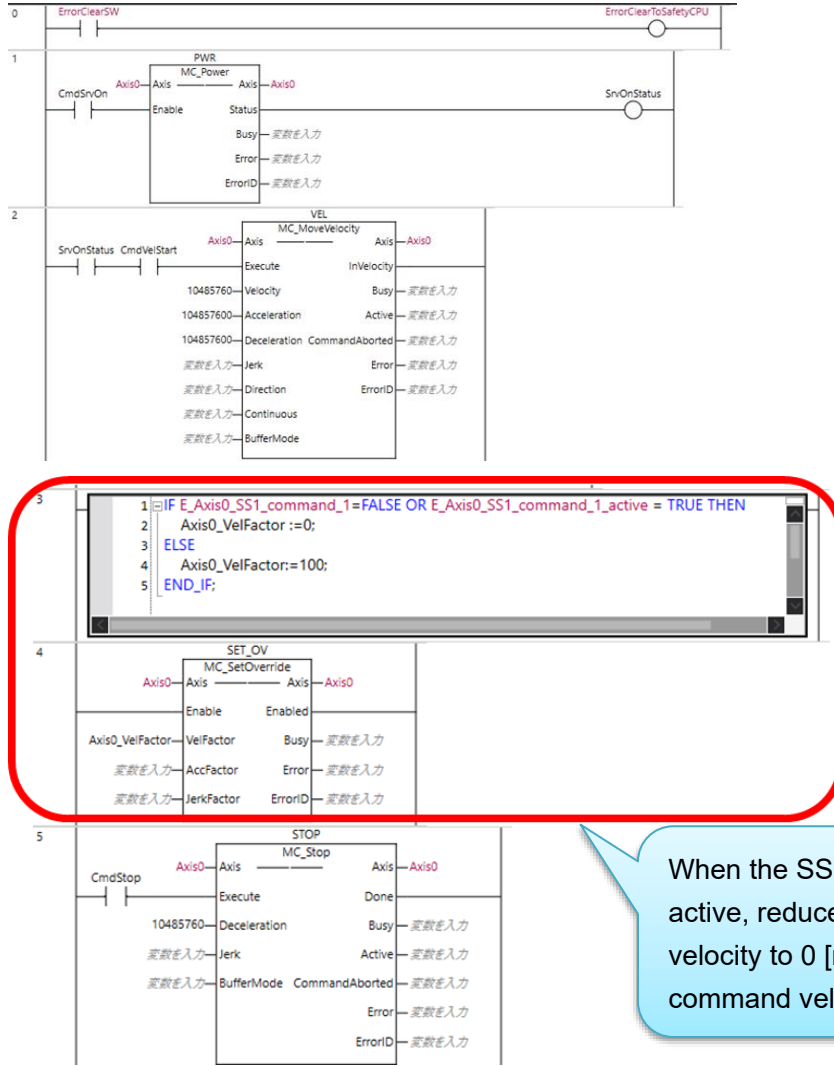

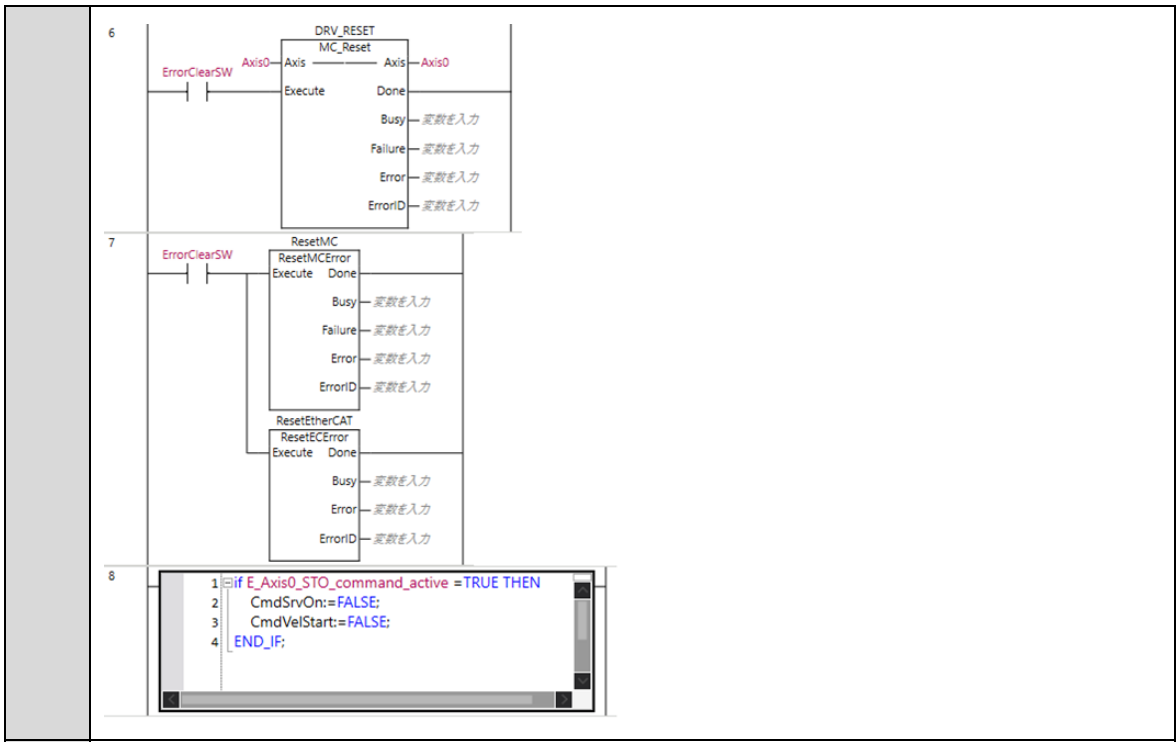

5. **Transfer to the standard controller.**

Select *new_Controller_0* from the list.

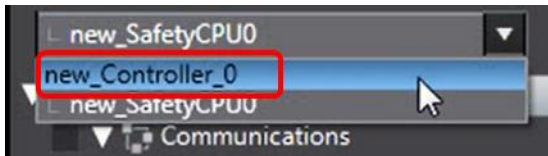

Connect to the standard controller.



Click the **Synchronization** Button to synchronize with the standard controller.

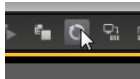

Transfer to the standard controller.

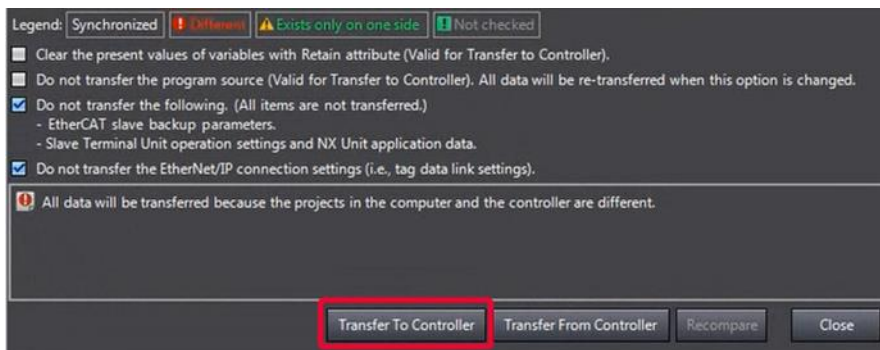

6. **Download the safety application.**
 Select *new_SafetyCPU0* from the list.

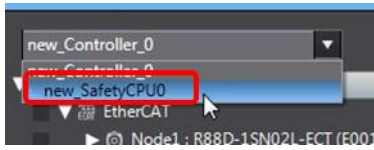

Click the **PROGRAM Mode** Button to switch to PROGRAM mode.

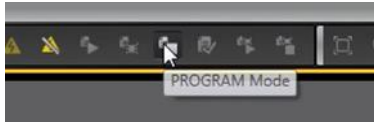

Click the **DEBUG Mode** Button to enter DEBUG mode.

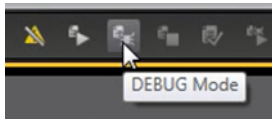

Click the **Start Debugging** Button to start DEBUG mode.

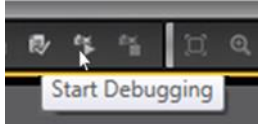

Click the **Safety Validation** Button.



Click the **OK** Button.

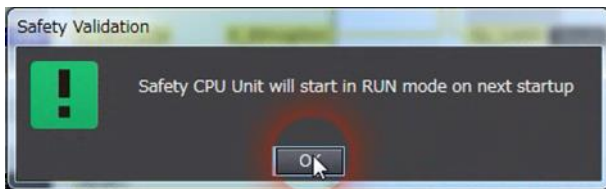

Click the **Run** Button.





7. **The FSoE communications are now established.**

The FS indicator is lit in green.

FS	Displays FSoE communications status.	Green	ON	FSoE slave connection established
			Flashing	FSoE slave connection establishment in progress
		Red	Flashing	Safety Parameter Error, Safety Communications Timeout, or other errors
		--	OFF	The safety functions are disabled by FSoE, the power is not supplied, or a fatal error including Self-diagnosis Error

■ Checking Operation of the SBC Function Interlocked with the SS1 Function

1. **Check that the Safety Key Selector Switch is in normal operating mode.**

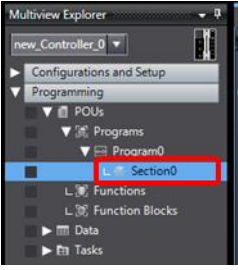

The image shows a safety key selector switch. The switch is in the 'RUN' position, which is highlighted with a red box. The text 'SAFETYACTIVE' is visible above the switch.
2. **Press the safety reset button.**

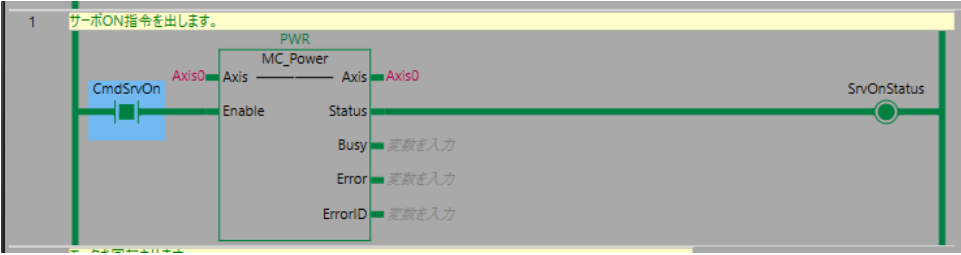
The image shows a blue safety reset button.
3. **Double-click Section0 to display the section.**

The image shows a screenshot of the Multiview Explorer software interface. The 'Section0' folder is selected and highlighted with a red box.
4. **Right-click CmdSrvOn and select Set/Reset – Set.**

The image shows a ladder logic diagram for the 'CmdSrvOn' function. The 'Enable' input is connected to a normally open contact. The 'Status' output is connected to a normally closed contact. The 'SrvOnStatus' output is connected to a normally open contact. The diagram is titled 'サーボON指令を出します。' (Issue servo ON command).

Check that the 7-segment LED display shows 'oE.'.

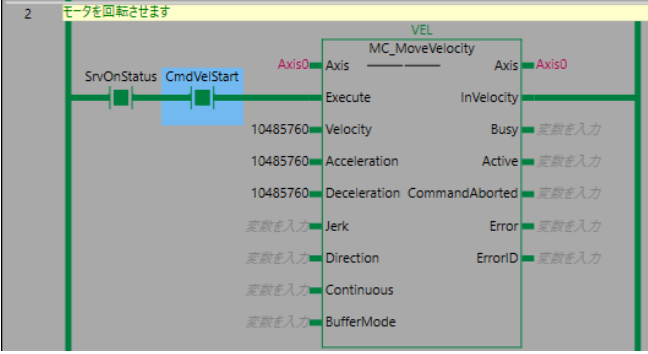

The image shows a 7-segment LED display showing the characters 'oE.'.
5. **Right-click CmdVelStart and select Set/Reset – Set.**

The image shows a ladder logic diagram for the 'CmdVelStart' function. The 'Execute' input is connected to a normally open contact. The 'InVelocity' output is connected to a normally open contact. The 'SrvOnStatus' output is connected to a normally open contact. The diagram is titled 'モータを回転させます' (Rotate motor).

Check that the Servomotor rotates at about 600 r/min.

6.

Operate the Safety Key Selector Switch to switch to safety active mode.



The Servomotor decelerates to a stop and the Servo Drive goes into STO state.

Check that the brake is applied.

(Make sure that no SBC stuck-at-high error is detected.)

Check that the 7-segment LED display shows 'st'.



4.3. Adding the Safe Stop 2 (SS2) Function

This section describes how to add the SS2 function to the project created in 3. *Performing Setup*.

The operation of the servo system set up in this section is explained below.

1. When the error clear button is pressed, the errors of the standard controller and Servo Drive are reset.
2. When the Safety Key Selector Switch is operated to switch to safety active mode, the standard controller lets the Servomotor decelerate to a stop. The Servo Drive activates the SOS function using the SS2 function to monitor the Servomotor position and velocity.
3. When the guard with the Safety-door Switch is opened while the SOS function is inactive, the motor torque is turned OFF.
4. When the Emergency Stop Pushbutton Switch is pressed, the motor torque is turned OFF.
5. When the safety reset button is pressed, the STO status is reset.

NX-series NX1 CPU Unit

Additional I/O power supply

Digital Input Unit

NX-series Safety CPU Unit

NX-series Safety Input Unit

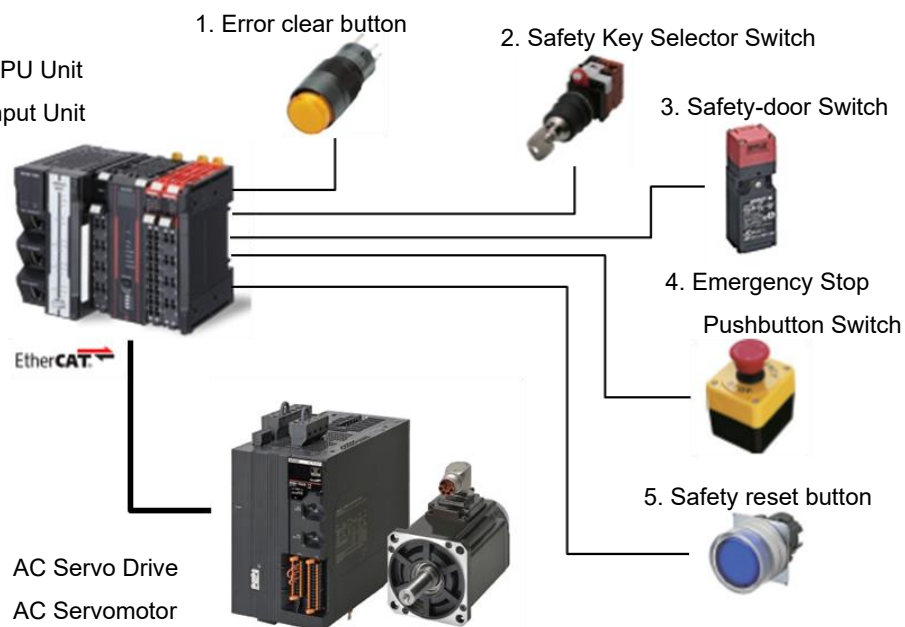

Input device	State	Operation
1. Error clear button	ON	Enable error reset command
	OFF	Disable error reset command
2. Safety Key Selector Switch	Normal operating mode	Run Servomotor at normal velocity and deactivate SOS function.
	Safety active mode	Make Servomotor decelerate to a stop and activate SOS function using SS2 function. When position or velocity exceeds SOS position or velocity zero window, Servo Drive goes into STO state and Excessive Limit Value Error occurs.
3. Safety-door Switch	Open	SLS function deactivated: Enable STO command SLS function activated: Disable STO command
	Close	Disable STO command
4. Emergency Stop Pushbutton Switch	ON	Enable STO command
	OFF	Disable STO command
5. Safety reset button	ON	Enable reset STO status command
	OFF	Disable reset STO status command

■ Operation of SS2 Function with Motion Control

1. When the Servo ON command is enabled, the Servo Drive turns ON the Servo.
2. When an operation command is enabled, the command velocity to the Servomotor is set to 600 r/min.
3. When the SS2 function is executed, the Servo Drive shifts to the SOS state after the wait time (SS2 time to SOS 1) and monitors the motor position and velocity.
The standard controller lets the Servomotor decelerate to a stop.
4. When the SS2 or SOS function is released, the Servo Drive goes into the normal state and stops monitoring the motor position and velocity.
The standard controller sets the command velocity to the Servomotor to 600 r/min.

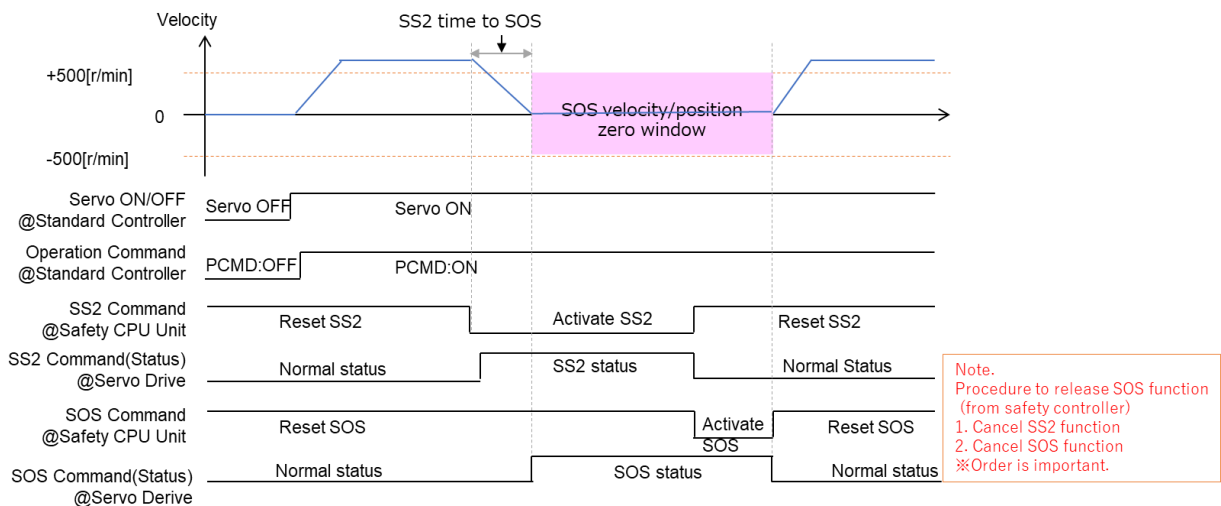

■ Setting the Safety Controller

1. Select *new_SafetyCPU0* from the list.

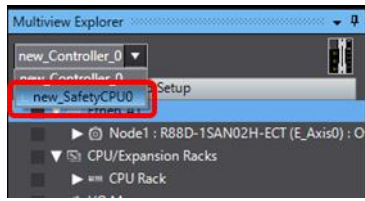

2. Double-click *SRA Parameters* and click the *Safety Function Assignment Settings* Button.

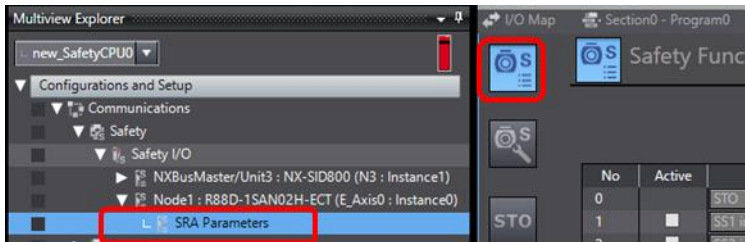

3. Assign STO, SS2 instance1, and SOS instance1.

Clear the selection of the Active Check Box.

SS2 command1 Active cannot be selected for No. 2 SS2 instance1.

Select SS2 instance1 to assign SS2 command1 Active.

No.	Active	Safety Functions	Details	Command	Status
0		STO	---	STO	STO Active
1	<input checked="" type="checkbox"/>	SS1 instance1	---	SS1 command1	Reserved
2	<input checked="" type="checkbox"/>	SS2 instance1	---	SS2 command1	Reserved
3	<input checked="" type="checkbox"/>	SOS instance1	---	SOS command1	SOS command1 Active
4		Reserved	---	Reserved	Reserved
5	<input checked="" type="checkbox"/>	SDip	---	SDip command	SDip command Active
6		SDin	---	SDin command	SDin command Active
7		Error Ack	---	Error Ack	Error
8		SS2 instance1	---	Not Assigned	SS2 command1 Active
9		Not Assigned	---	Not Assigned	Not Assigned
10		Not Assigned	---	Not Assigned	Not Assigned
11		Not Assigned	---	Not Assigned	Not Assigned
12		Not Assigned	---	Not Assigned	Not Assigned
13		Not Assigned	---	Not Assigned	Not Assigned
14		Not Assigned	---	Not Assigned	Not Assigned
15		Not Assigned	---	Not Assigned	Not Assigned

4. Click the **SS2** Button or the **...** Button to display the SS2 Detailed Settings view.

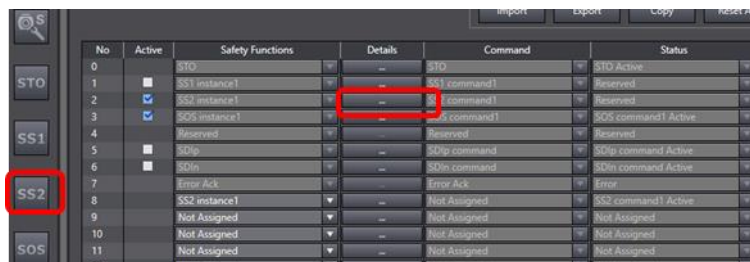

5. **Set SS2 parameters.**

In this Guide, set as follows:

Name	Value	Unit
SS2 time to SOS 1	1000	ms
SS2 time for velocity zero 1	500	ms

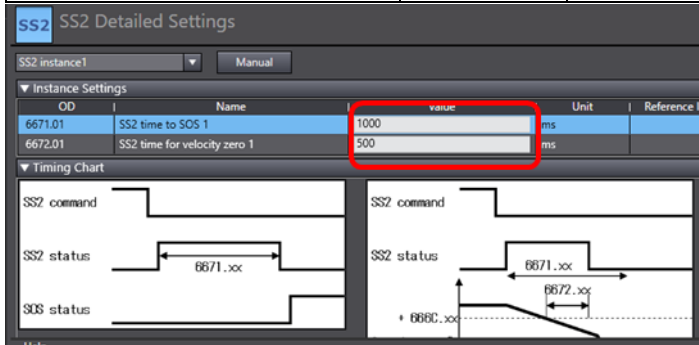

6. **Click the  Button or the  Button to display the SOS Detailed Settings view.**

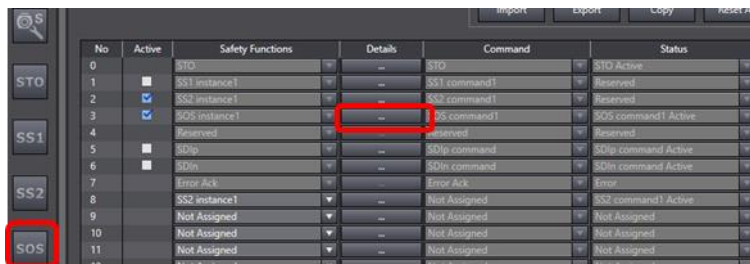

7. **Set SOS parameters.**

In this Guide, set as follows:

Name	Value	Unit
SOS position zero window 1	131072	Encoder Unit
SOS velocity zero window 1	60	r/min

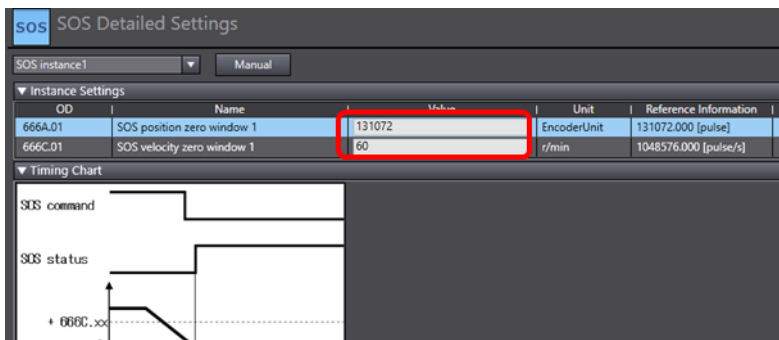

8. Open the I/O Map and create device variables.

Port	Variable name
SOS command1 Active for R88D-1SAN02H-ECT	E_Axis0_SOS_command1_Active
SS2 command1 for R88D-1SAN02H-ECT	E_Axis0_SS2_command1
SOS command1 for R88D-1SAN02H-ECT	E_Axis0_SOS_command1

Position	Port	R/W	Data Type	Variable	Variable Comment	Variable Type
	▼ CPU/Expansion Racks					
	NXBusMa					
	NXBusMa					
	▼ EtherCAT Network					
	EtherCAT					
	Master					
	Node1					
	▼ R88D-1SAN02H-ECT					
	▼ Safety Inputs					
	STO Active	R	SAFEBOOL	E_Axis0_STO_Active		Global Variables
	SOS command1 Active	R	SAFEBOOL	E_Axis0_SOS_command1_Active		Global Variables
	SDIp command Active	R	SAFEBOOL			
	SDIn command Active	R	SAFEBOOL			
	Error	R	SAFEBOOL	E_Axis0_Error		Global Variables
	SS2 command1 Active	R	SAFEBOOL	E_Axis0_SS2_command1_Active		Global Variables
	Not Assigned Bit 09	R	SAFEBOOL			
	Not Assigned Bit 10	R	SAFEBOOL			
	Not Assigned Bit 11	R	SAFEBOOL			
	Not Assigned Bit 12	R	SAFEBOOL			
	Not Assigned Bit 13	R	SAFEBOOL			
	Not Assigned Bit 14	R	SAFEBOOL			
	Safety Connection Status	R	SAFEBOOL	E_Axis0_Safety_Connection_Status		Global Variables
	▼ Safety Outputs					
	STO	W	SAFEBOOL	E_Axis0_STO		Global Variables
	SS1 command1	W	SAFEBOOL			
	SS2 command1	W	SAFEBOOL	E_Axis0_SS2_command1		Global Variables
	SOS command1	W	SAFEBOOL	E_Axis0_SOS_command1		Global Variables
	SDIp command	W	SAFEBOOL			
	SDIn command	W	SAFEBOOL			
	Error Ack	W	SAFEBOOL	E_Axis0_Error_Ack		Global Variables

9. Create a safety program.

Add the following code to AutoProgram1.

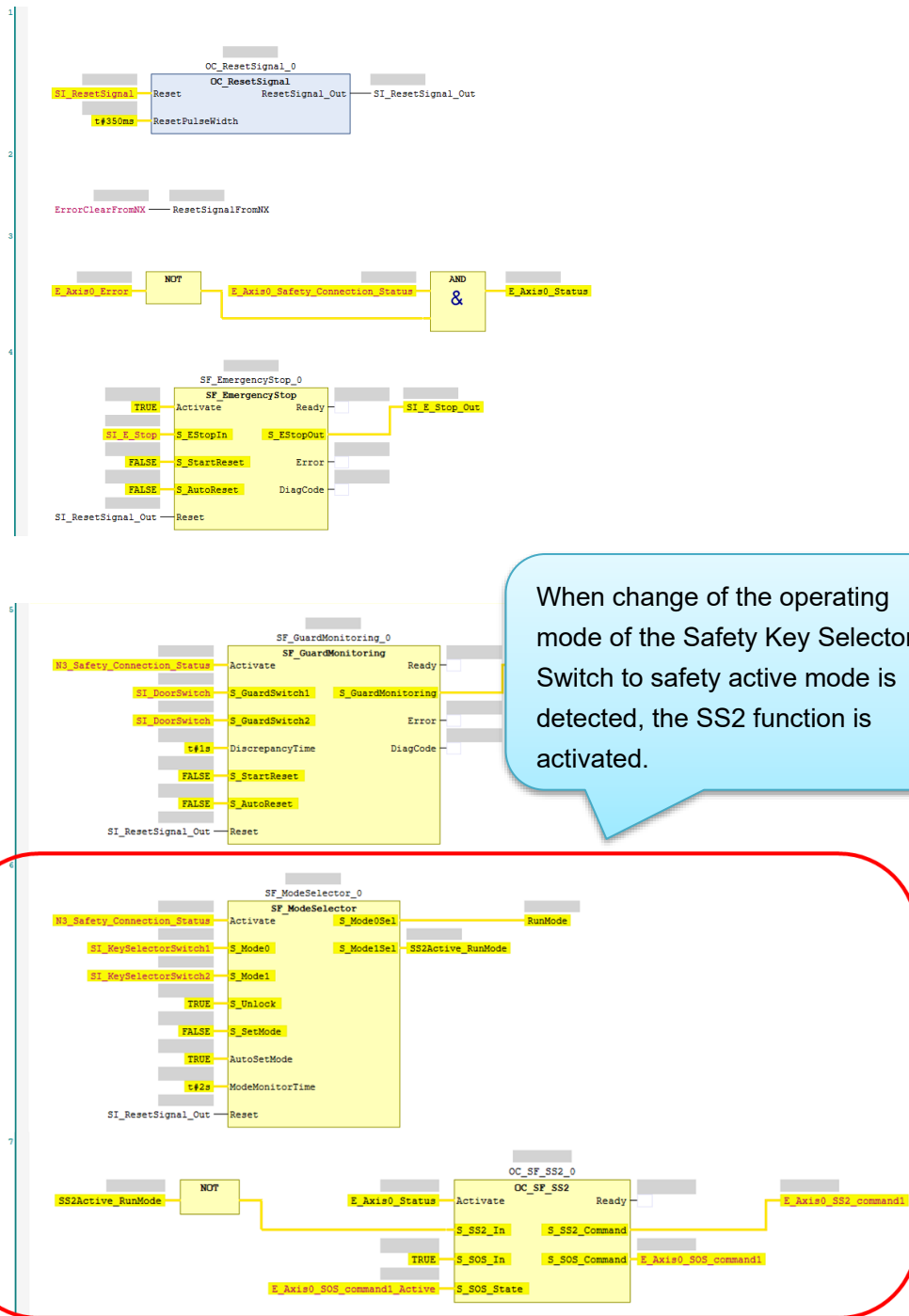

When change of the operating mode of the Safety Key Selector Switch to safety active mode is detected, the SS2 function is activated.

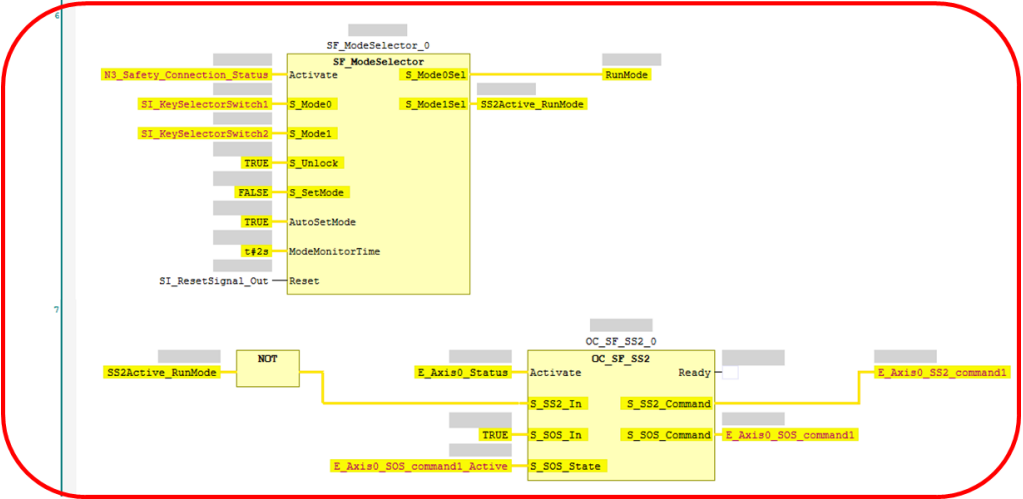

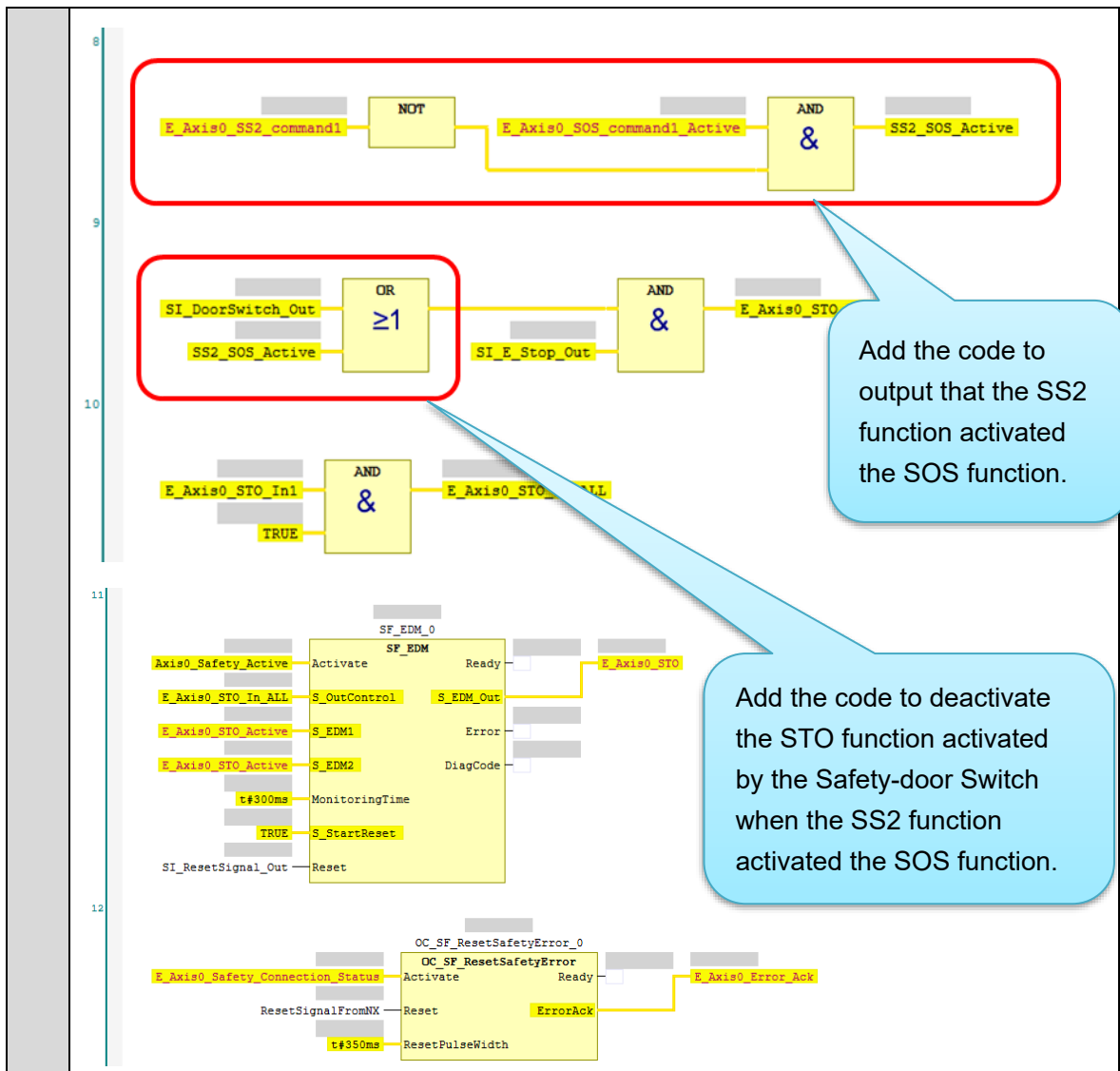

Add the code to output that the SS2 function activated the SOS function.

Add the code to deactivate the STO function activated by the Safety-door Switch when the SS2 function activated the SOS function.

■ Setting the Standard Controller

1. Select **new_Controller_0** from the list.

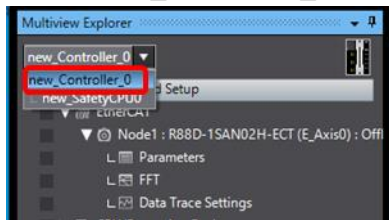

2. Double-click **I/O Map**.

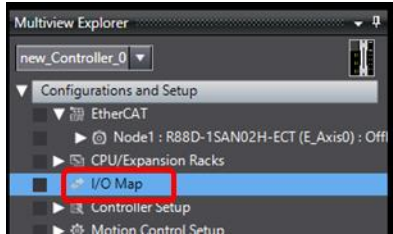

3. Create device variables.

Port	Variable name
SS2 command 1 for R88D-1SAN02H-ECT	E_Axis0_SS2_command_1
SOS command 1 active for R88D-1SAN02H-ECT	E_Axis0_SOS_command_1_active

Position	Port	Description	R/W	Data Type	Variable	Variable Comment	Variable Type	
Node1	EtherCAT Network Configuration							
	R88D-1SAN02H-ECT							
		Controlword	Controlword	W	WORD			
		Target position	Target position	W	DINT			
		Target velocity	Target velocity	W	DINT			
		Target torque	Target torque	W	INT			
		Modes of operation	Modes of operation	W	SINT			
		Touch probe function	Touch probe function	W	WORD			
		Signal repair	Signal repair	R	BOOL			
		Mirror Safety controlword						
		STO command	Mirror Safety Controlword	R	BOOL			
		SS1 command 1	Mirror Safety Controlword	R	BOOL			
		SS2 command 1	Mirror Safety Controlword	R	BOOL	E_Axis0_SS2_command_1	Global Variables	
		Mirror Safety Controlword 15	Mirror Safety Controlword	R	BOOL			
		Mirror Safety statusword						
	STO command active	Mirror Safety Statusword 0	R	BOOL	E_Axis0_STO_command_active	Global Variables		
	Mirror Safety Statusword 1	Mirror Safety Statusword 1	R	BOOL				
	Mirror Safety Statusword 2	Mirror Safety Statusword 2	R	BOOL				
	SOS command 1 active	Mirror Safety Statusword 3	R	BOOL	E_Axis0_SOS_command_1_active	Global Variables		

4. **Create code for the standard program.**

Add the code to change the command velocity.

- When the SS2 and SOS functions are active, reduce the command velocity to 0 r/min.
- When the SS2 and SOS functions are inactive, increase the command velocity to 600 r/min.

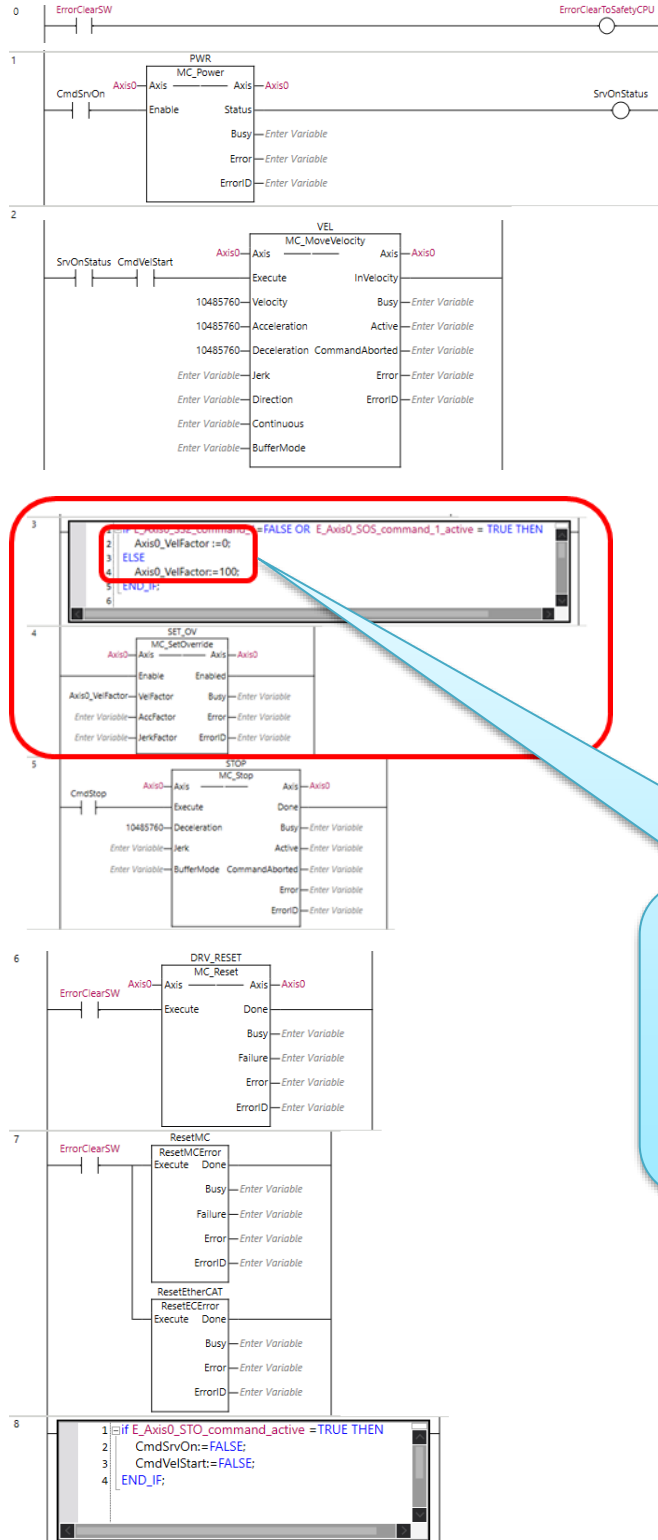

0 [r/min] (0% of command velocity) when the SS2 and SOS functions are active.
 600 [r/min] (100% of command velocity) when the SS2 and SOS functions are inactive.

5. **Transfer to the standard controller.**

Select *new_Controller_0* from the list.

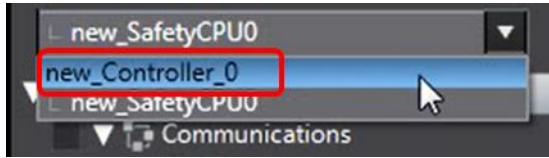

Connect to the standard controller.



Click the **Synchronization** Button to synchronize with the standard controller.



Transfer to the standard controller.

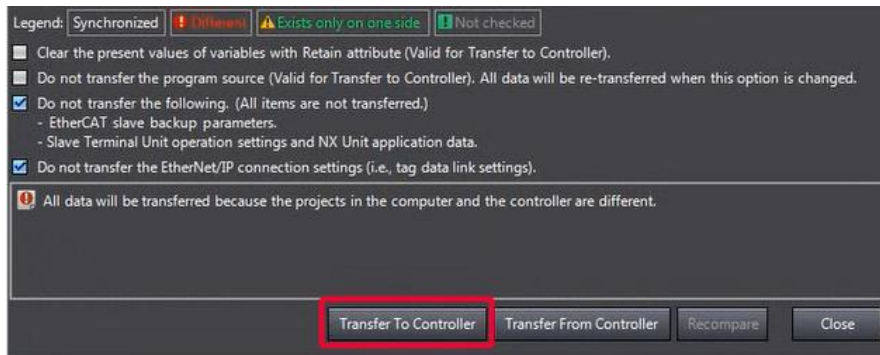

6. **Download the safety application.**

Select *new_SafetyCPU0* from the list.

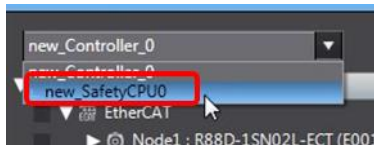

Click the **PROGRAM Mode** Button to switch to PROGRAM mode.

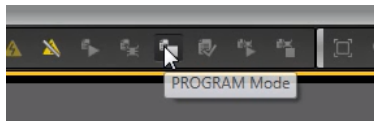

Click the **DEBUG Mode** Button to enter DEBUG mode.

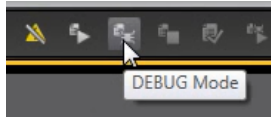

Click the **Start Debugging** Button to start DEBUG mode.

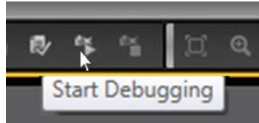

Click the **Safety Validation** Button.

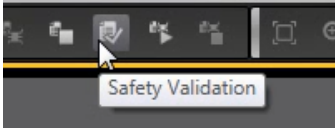

Click the **OK** Button.

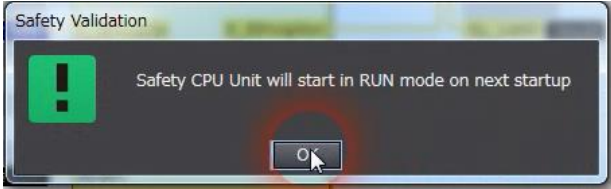

Click the **Run** Button.



7. **The FSoE communications are now established.**
The FS indicator is lit in green.

FS	Displays FSoE communications status.	Green	ON	FSoE slave connection established
			Flashing	FSoE slave connection establishment in progress
		Red	Flashing	Safety Parameter Error, Safety Communications Timeout, or other errors
		--	OFF	The safety functions are disabled by FSoE, the power is not supplied, or a fatal error including Self-diagnosis Error

■ Checking Operation of the SS2 Function

1. **Check that the Safety Key Selector Switch is in normal operating mode.**



2. **Press the safety rest button.**



3. **Double-click *Section0* to display the section.**

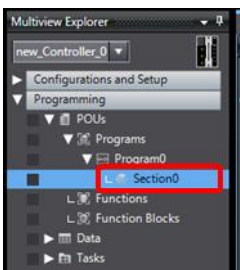

4. **Right-click *CmdSrvOn* and select *Set/Reset – Set*.**

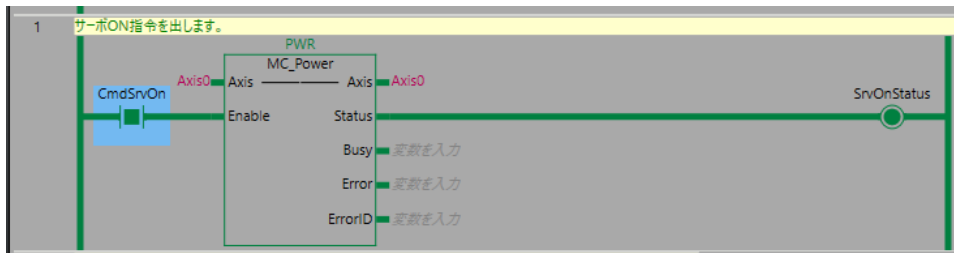

Check that the 7-segment LED display shows 'oE.'



5. **Right-click *CmdVelStart* and select *Set/Reset – Set*.**

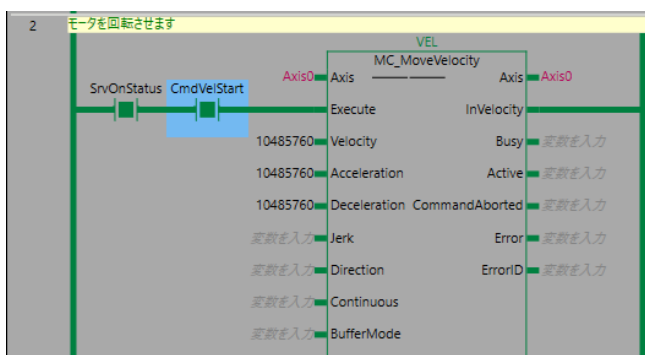

Check that the Servomotor rotates at about 600 r/min.

6. **Operate the Safety Key Selector Switch to switch to safety active mode.**



Check that the Servomotor decelerates to a stop.
Check that the 7-segment LED display shows 'SF'.



7. **Open the guard with the Safety-door Switch.**



Check that the 7-segment LED display still shows 'SF'.

8. **Close the guard and press the safety reset switch.**

9. **Operate the Safety key Selector Switch to switch to normal operating mode.**



SAFETYACTIVE

RUN



Check that the Servomotor rotates at about 600 r/min.

Check that the 7-segment LED display shows 'oE.'



4.4. Adding the Safe Operating Stop (SOS) Function

This section describes how to add the SOS function to the project created in 3. *Performing Setup*.

The operation of the servo system set up in this section is explained below.

1. When the error clear button is pressed, the errors of the standard controller and Servo Drive are reset.
2. When the Safety Key Selector Switch is operated to switch to safety active mode, the Servo Drive activates the SOS function to monitor the Servomotor position and velocity.
3. When the guard with the Safety-door Switch is opened while the SOS function is inactive, the motor torque is turned OFF.
4. When the Emergency Stop Pushbutton Switch is pressed, the motor torque is turned OFF.
5. When the safety reset button is pressed, the STO status is reset.

NX-series NX1 CPU Unit

Additional I/O power supply

Digital Input Unit

NX-series Safety CPU Unit

NX-series Safety Input Unit

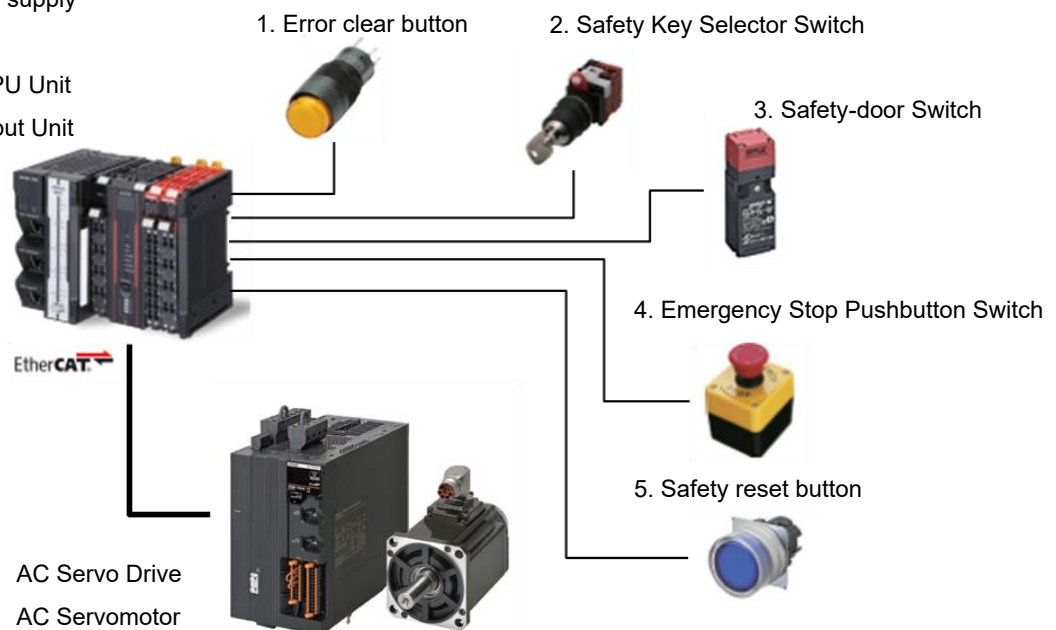

Input device	State	Operation
1. Error clear button	ON	Enable error reset command
	OFF	Disable error reset command
2. Safety Key Selector Switch	Normal operating mode	Deactivate SOS function.
	Safety active mode	Activate SOS function. When position or velocity exceeds SOS position or velocity zero window, Servo Drive goes into STO state and Excessive Limit Value Error occurs.

Input device	State	Operation
3. Safety-door Switch	Open	SOS function deactivated: Enable STO command SOS function activated: Disable STO command
	Close	Disable STO command
4. Emergency Stop Pushbutton Switch	ON	Enable STO command
	OFF	Disable STO command
5. Safety reset button	ON	Enable reset STO status command
	OFF	Disable reset STO status command

■ Operation of SOS Function with Motion Control

1. When the Servo ON command is enabled, the Servo Drive turns ON the Servo.
2. When an operation command is enabled, the command velocity to the Servomotor is set to 600 r/min.
3. When the operation command is disabled, the Servomotor decelerates to a stop.
4. When the SOS function is executed after the Servomotor stops, the Servo Drive shifts to the SOS state and monitors the motor position and velocity.
5. When the SOS function is released, the Servo Drive goes into the normal state. When an operation command is enabled, the command velocity to the Servomotor is set to 600 r/min.

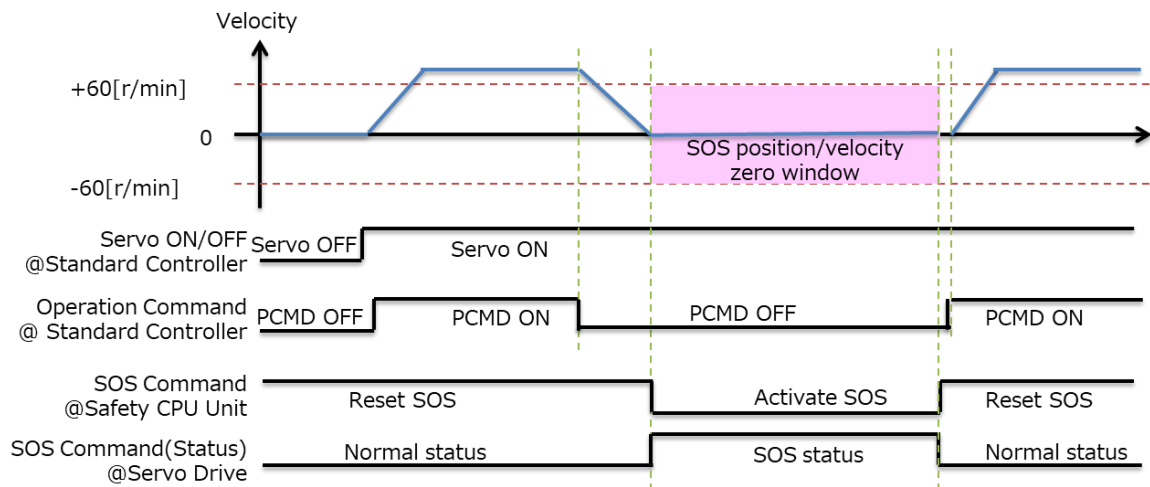

■ Setting the Safety Controller

1. Select *new_SafetyCPU0* from the list.

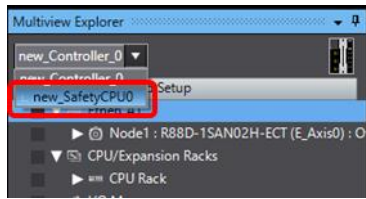

2. Double-click *SRA Parameters* and click the *Safety Function Assignment Settings* Button.

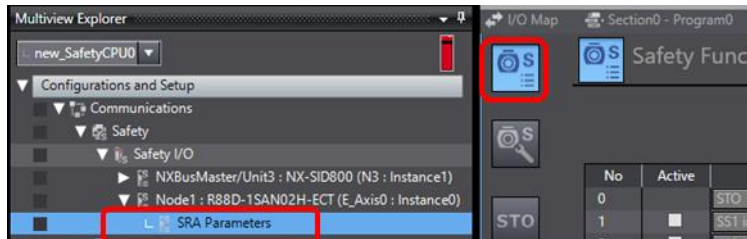

3. Assign *STO*, *SS2 instance1*, and *SOS instance1*.

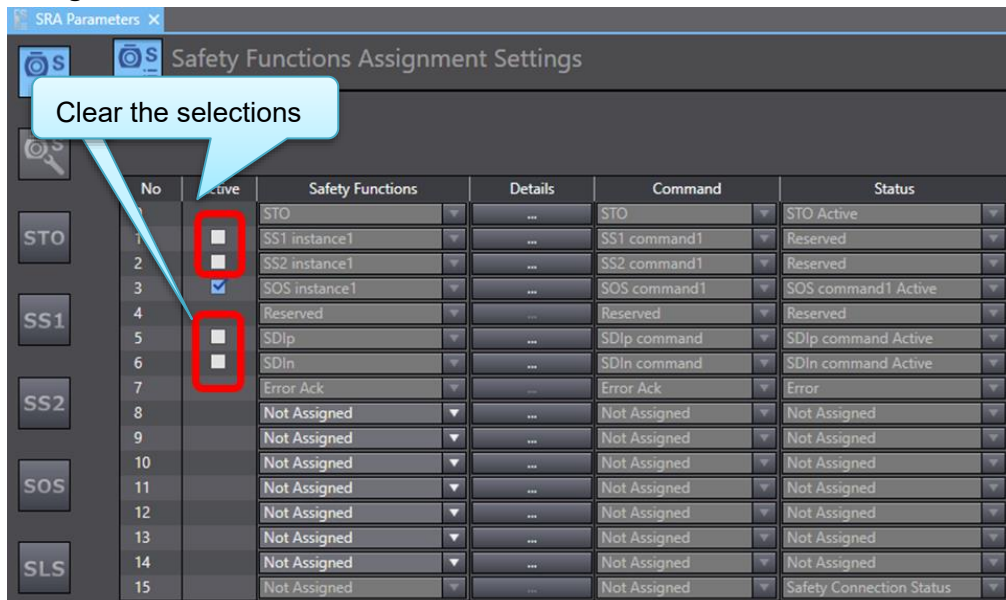

4. Click the **SS2** Button to display the **SOS Detailed Settings** view.
You can also use the **...** Button to display the **SOS Detailed Settings** view.

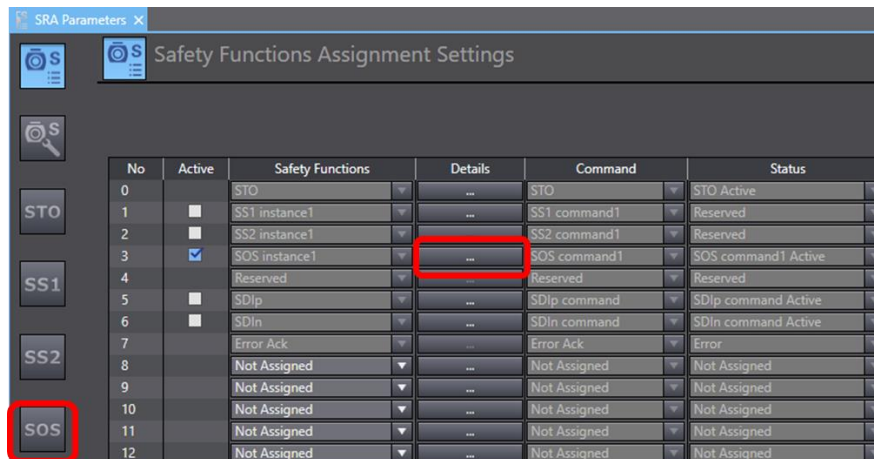

5. Set SOS parameters.

In this guide, set them as follows.

Name	Value	Unit
SOS position zero window	131072	EncoderUnit
SOS velocity zero window	60	r/min

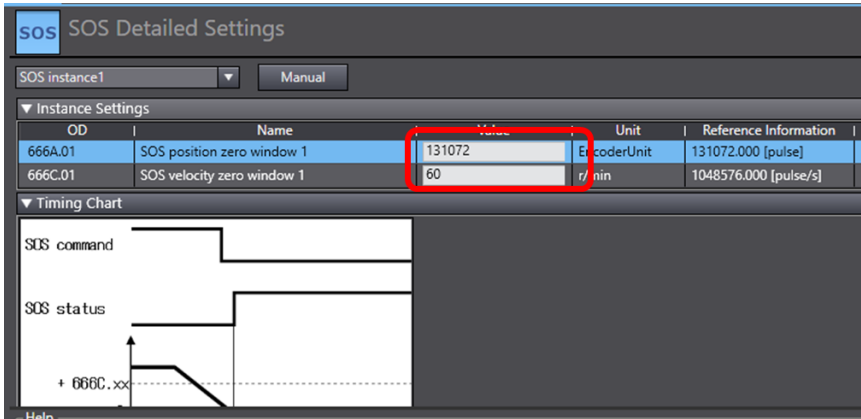

6. Open the I/O Map and create device variables.

Port	Variable name
SOS command1 Active for R88D-1SAN02H-ECT	E_Axis0_SOS_command1_Active
SOS command1 for R88D-1SAN02H-ECT	E_Axis0_SOS_command1

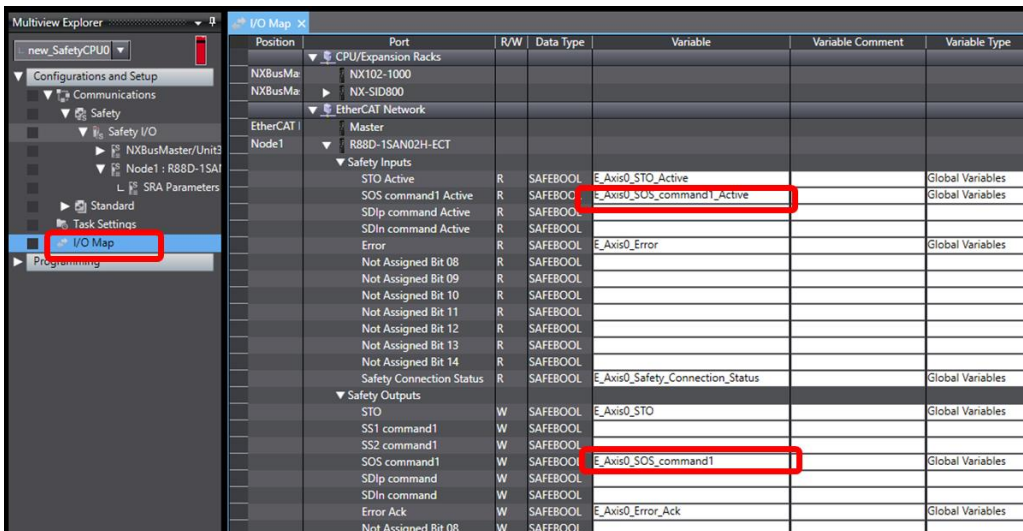

7. Create a safety program.

Add the following code to AutoProgram1.

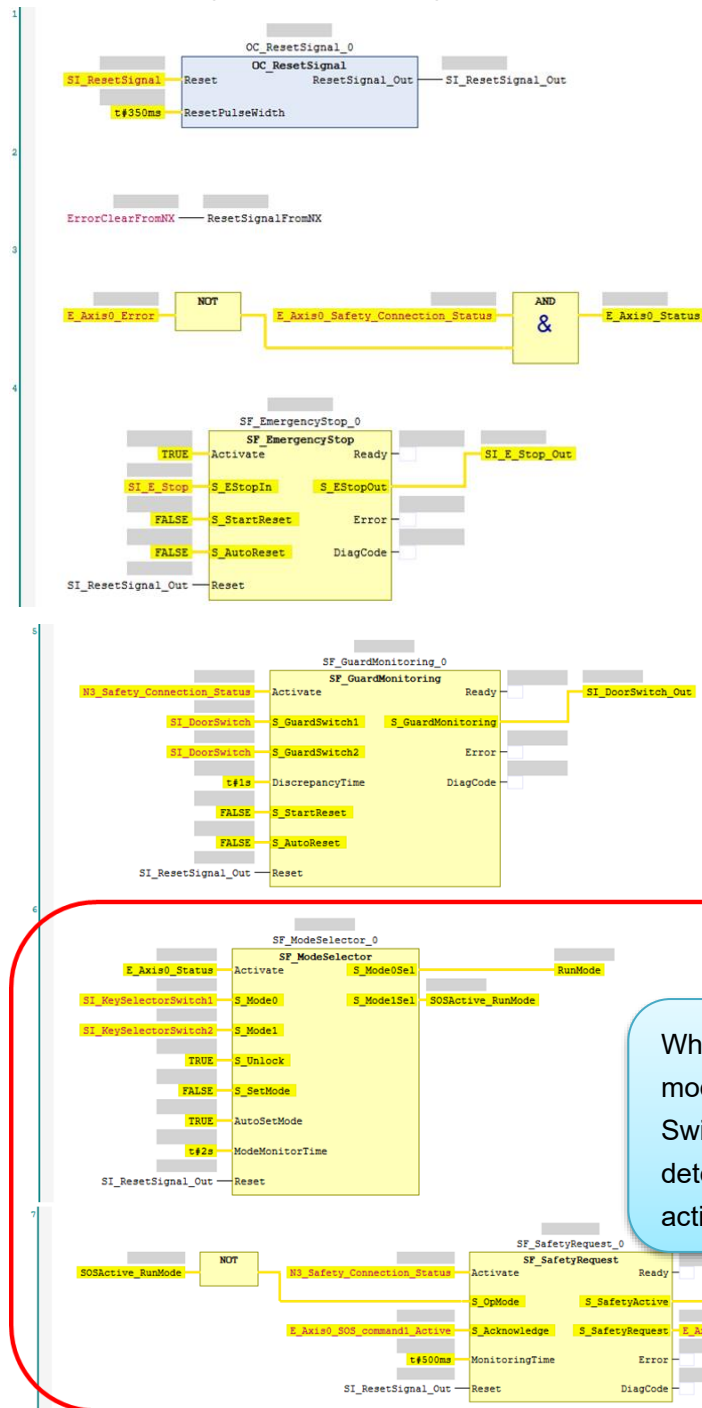

When change of the operating mode of the Safety Key Selector Switch to safety active mode is detected, the SOS function is activated.

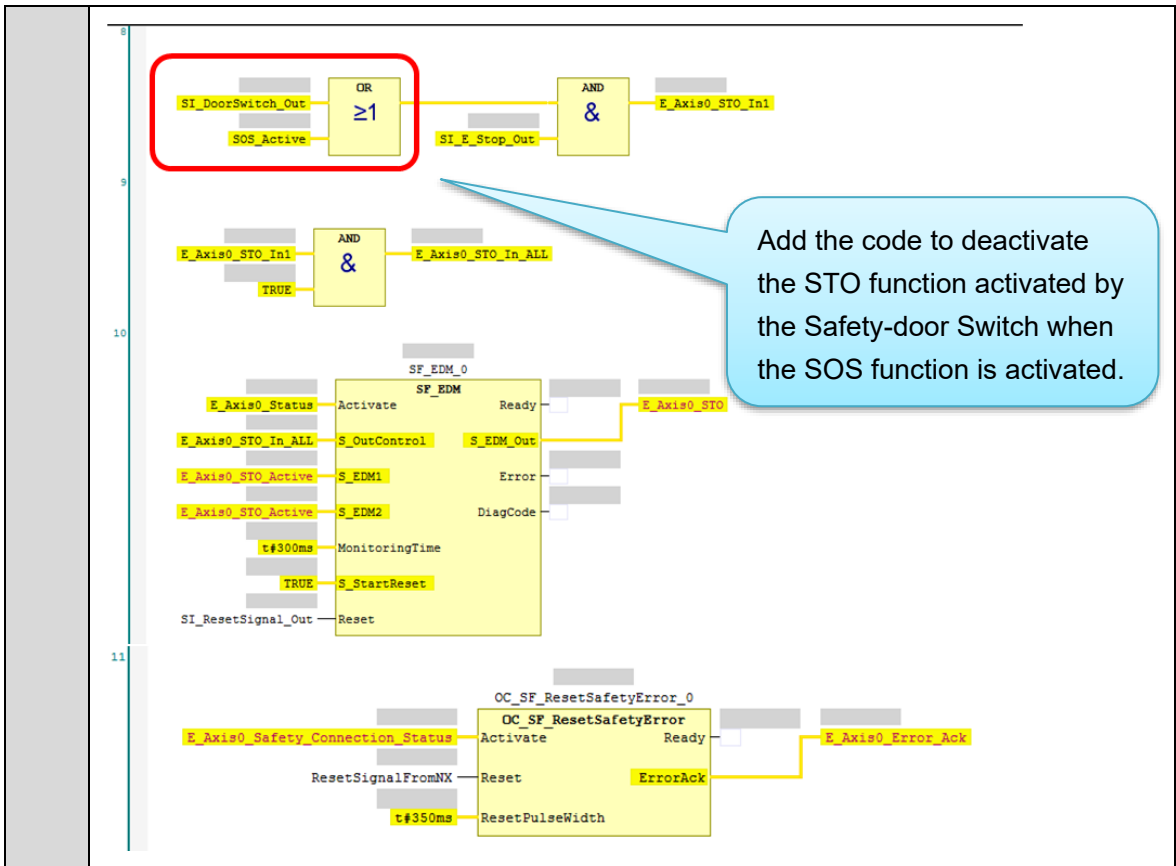

■ Setting the Standard Controller

1. The program is the same as that of the STO function. For further details, refer to **3.6 Creating a Motor Control Program**. Confirm that the program is as follows.

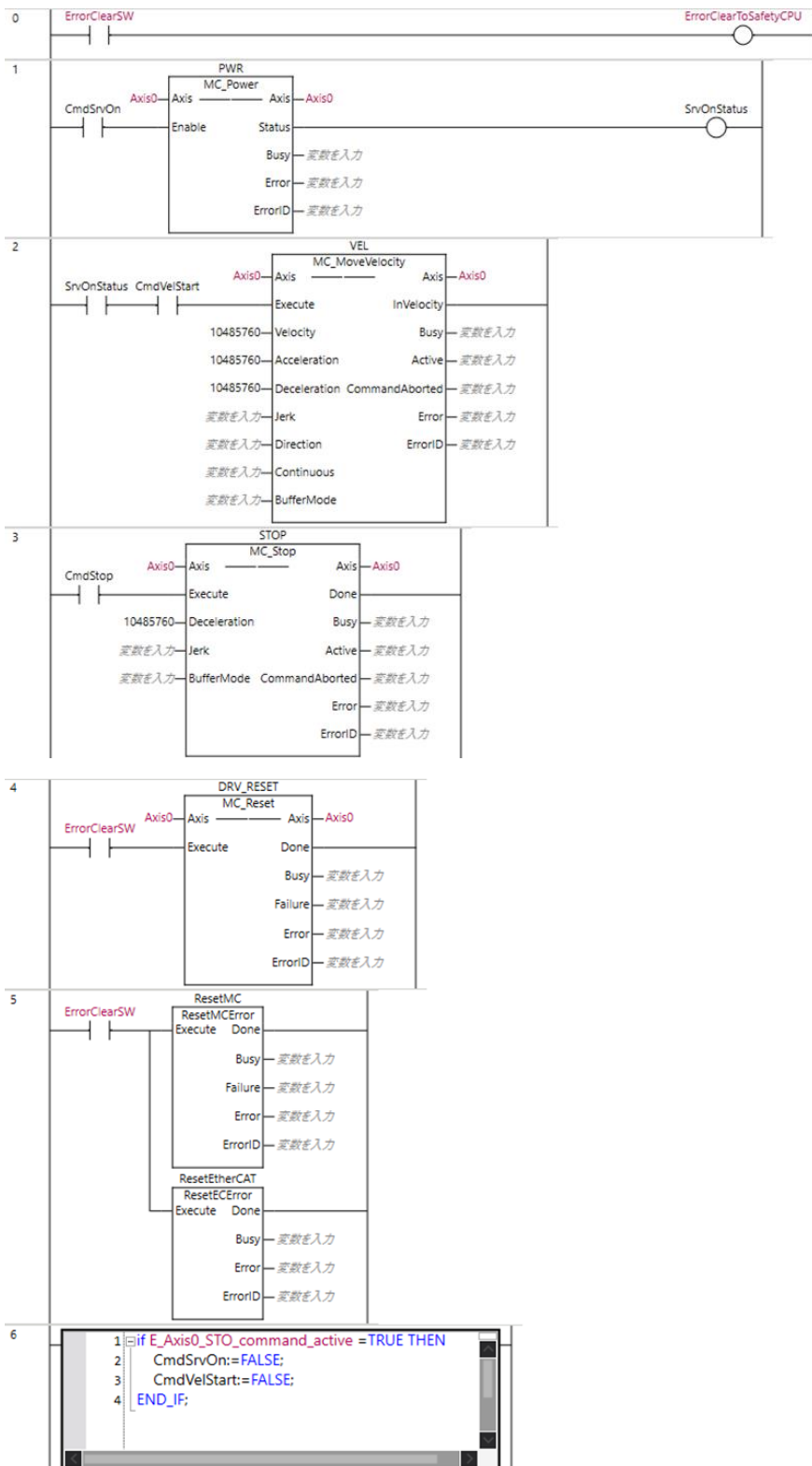

2. **Transfer to the standard controller.**

Select *new_Controller_0* from the list.

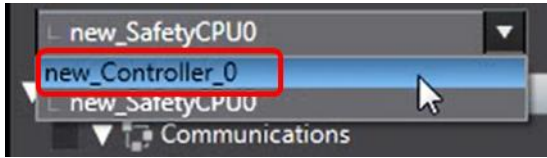

Connect to the standard controller.



Click the **Synchronization** Button to synchronize with the standard controller.



Transfer to the standard controller.

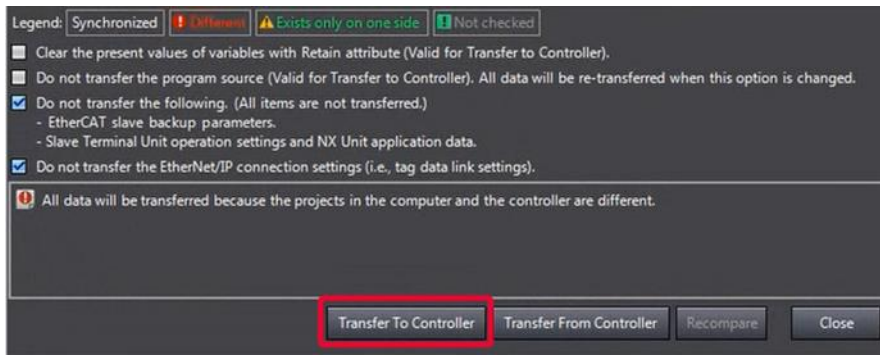

3. **Download the safety application.**

Select *new_SafetyCPU0* from the list.

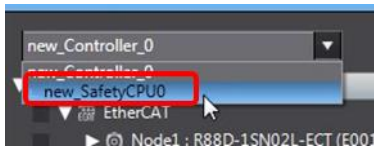

Click the **PROGRAM Mode** Button to switch to PROGRAM mode.

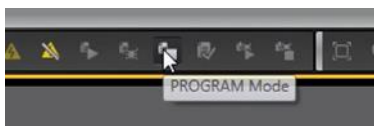

Click the **DEBUG Mode** Button to enter DEBUG mode.

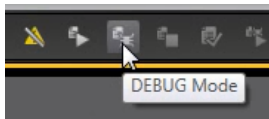

Click the **Start Debugging** Button to start DEBUG mode.

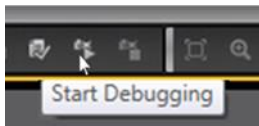

Click the **Safety Validation** Button.

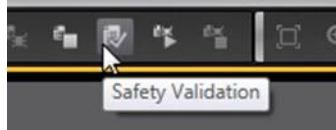

Click the **OK** Button.

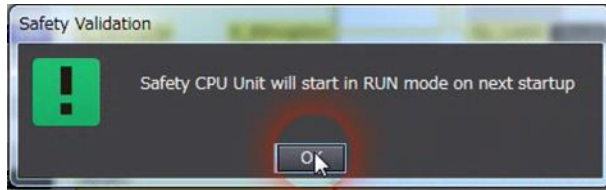

Click the **Run** Button.

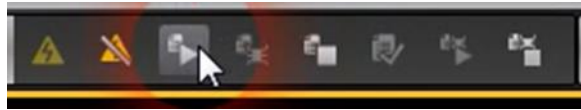





4. **The FSoE communications are now established.**

The FS indicator is lit in green.

FS	Displays FSoE communications status.	Green	ON	FSoE slave connection established
			Flashing	FSoE slave connection establishment in progress
		Red	Flashing	Safety Parameter Error, Safety Communications Timeout, or other errors
		---	OFF	The safety functions are disabled by FSoE, the power is not supplied, or a fatal error including Self-diagnosis Error

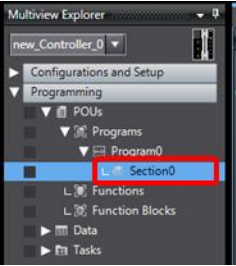
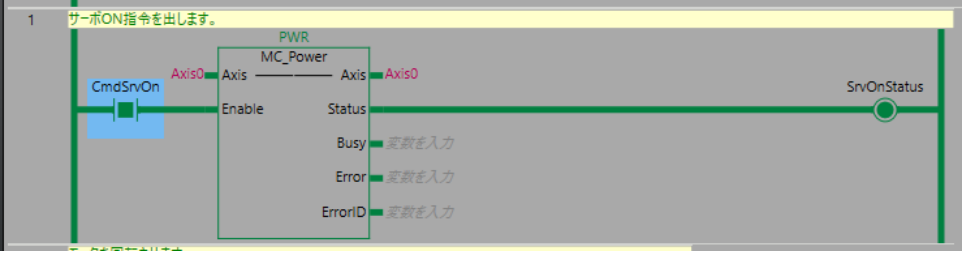
■ Checking Operation of the SOS Function

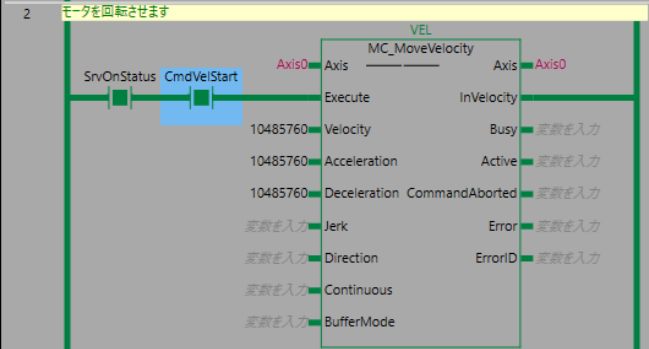
1.	<p>Check that the Safety Key Selector Switch is in normal operating mode.</p> 
2.	<p>Press the safety reset button.</p> 
3.	<p>Double-click <i>Section0</i> to display the section.</p> 
4.	<p>Right-click <i>CmdSrvOn</i> and select <i>Set/Reset – Set</i>.</p>  <p>Check that the 7-segment LED display shows 'oE.'</p> 
5.	<p>Right-click <i>CmdVelStart</i> and select <i>Set/Reset – Set</i>.</p>  <p>Check that the Servomotor rotates at about 600 r/min.</p>
6.	<p>Right-click <i>CmdVelStart</i> and select <i>Set/Reset – Reset</i>.</p> <p>The Servomotor decelerates to a stop.</p>

7. **Operate the Safety Key Selector Switch to switch to safety active mode.**



Check that the 7-segment LED display shows 'SF'.

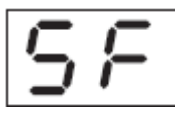

8. **Open the guard with the Safety-door Switch.**



Check that the 7-segment LED display still shows 'SF'.

9. **Close the guard and press the safety reset switch.**

10. **Operate the Safety Key Selector Switch to switch to normal operating mode.**



Check that the 7-segment LED display shows 'oE'.

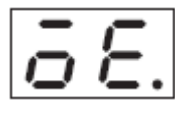

11. **Right-click *CmdVelStart* and select *Set/Reset – Set*.**

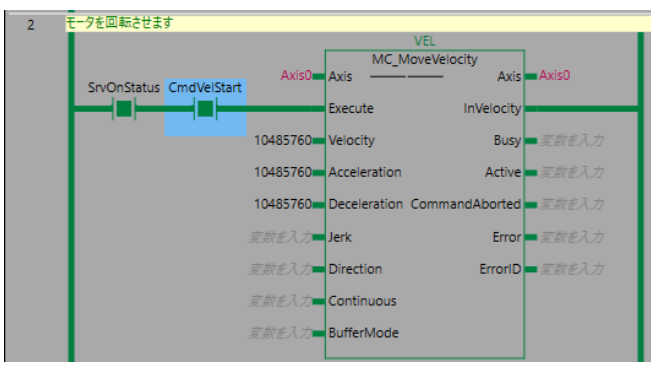

The Servomotor rotates at about 600 r/min.

4.5. Adding the Safely-limited Speed (SLS) Function

This section describes how to add the SLS function to the project created in 3. *Performing Setup*.

The operation of the servo system set up in this section is explained below.

1. When the error clear button is pressed, the errors of the standard controller and Servo Drive are reset.
2. When the Safety Key Selector Switch is operated to switch to safety active mode, the standard controller changes the velocity command value to low speed. The Servo Drive activates the SLS function and monitors the motor velocity.
3. When the guard with the Safety-door Switch is opened while the SLS function is inactive, the motor torque is turned OFF.
4. When the Emergency Stop Pushbutton Switch is pressed, the motor torque is turned OFF.
5. When the safety reset button is pressed, the STO status is reset.

NX-series NX1 CPU Unit

Additional I/O power supply

Digital Input Unit

NX-series Safety CPU Unit

NX-series Safety Input Unit

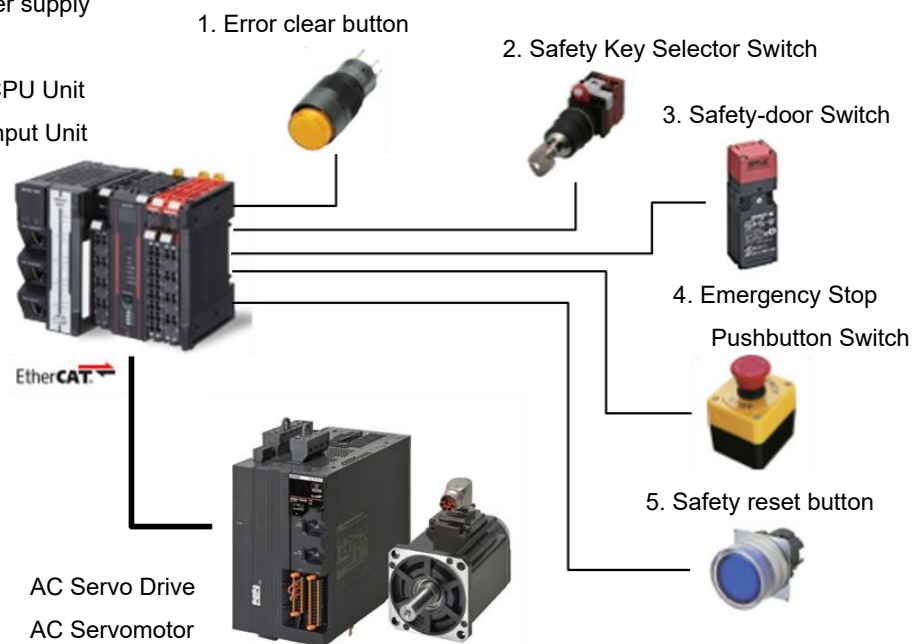

Input device	State	Operation
1. Error clear button	ON	Enable error reset command
	OFF	Disable error reset command
2. Safety Key Selector Switch	Normal operating mode	Run Servomotor at 600 [r/min] and deactivate SLS function.
	Safety active mode	Run Servomotor at 60 [r/min] and activate SLS function. When velocity exceeds SLS velocity limit, Servo Drive goes into STO state and Excessive Limit Value Error occurs.
3. Safety-door Switch	Open	SLS function deactivated: Enable STO command SLS function activated: Disable STO command
	Close	Disable STO command
4. Emergency Stop Pushbutton Switch	ON	Enable STO command
	OFF	Disable STO command
5. Safety reset button	ON	Enable reset STO status command
	OFF	Disable reset STO status command

□ Operation of SLS Function with Motion Control

1. When the Servo ON command is enabled, the Servo Drive turns ON the Servo.
2. When an operation command is enabled, the command velocity to the Servomotor is set to 600 r/min.
3. When the SLS function is executed, the Servo Drive shifts to the SLS state after the wait time (SLS time to velocity monitoring 1) and monitors the motor velocity. The standard controller sets the command velocity to the Servomotor to 60 r/min.
4. When the SLS function is released, the Servo Drive goes into the normal state and stops monitoring the motor velocity. The standard controller sets the command velocity to the Servomotor to 600 r/min.

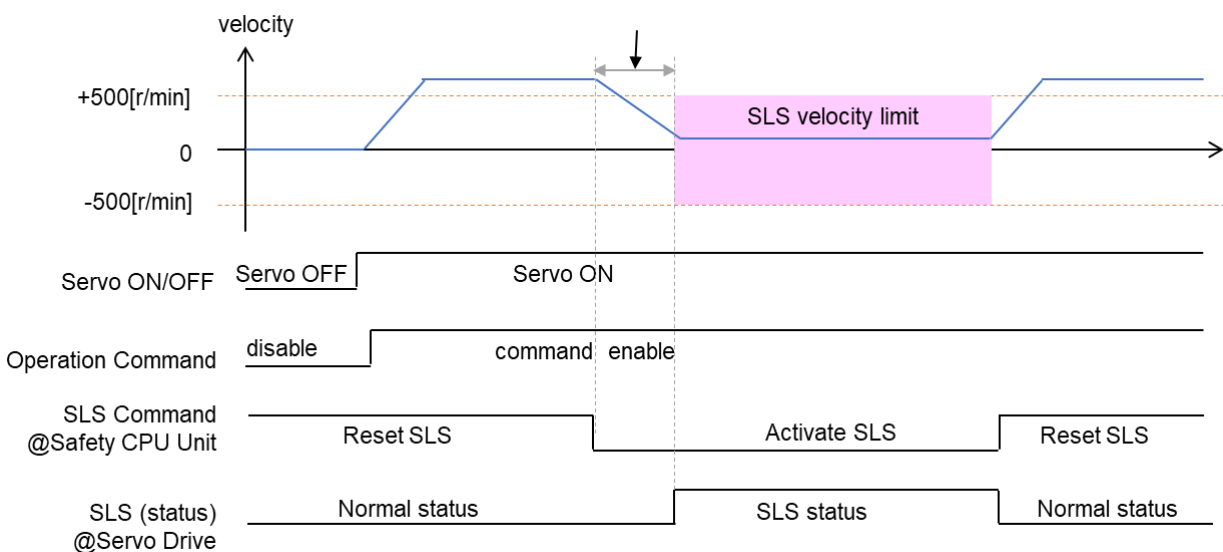

■ Setting the Safety Controller

1. Select *new_SafetyCPU0* from the list.

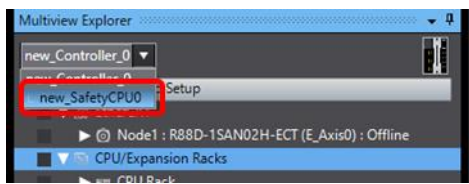

2. Double-click *SRA Parameters* and click the *Safety Function Assignment Settings* Button.

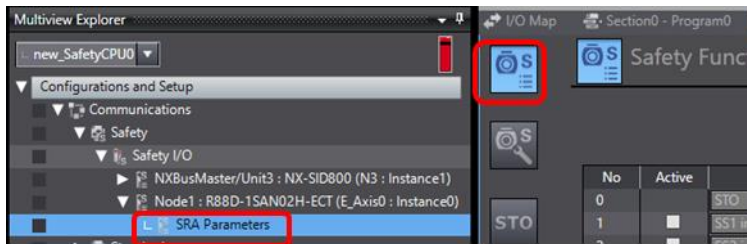

3. Assign SLS instance1.

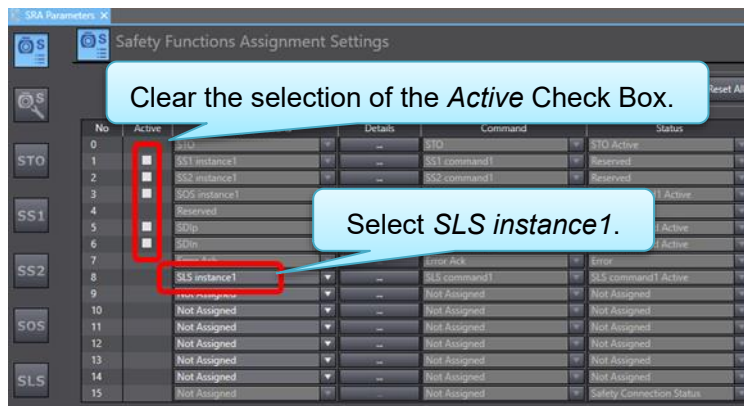

4. Click the **SLS** Button or the **...** Button to display the SLS Detailed Settings view.



5. **Set SLS parameters.**

In this Guide, set as follows:

Name	Value	Unit
SLS time to velocity monitoring 1	1000	ms
SLS velocity limit 1	500	r/min
SLS time for velocity in limits 1	1000	ms
Error Detection Activate In SLS Deactivate 1	Activate	-

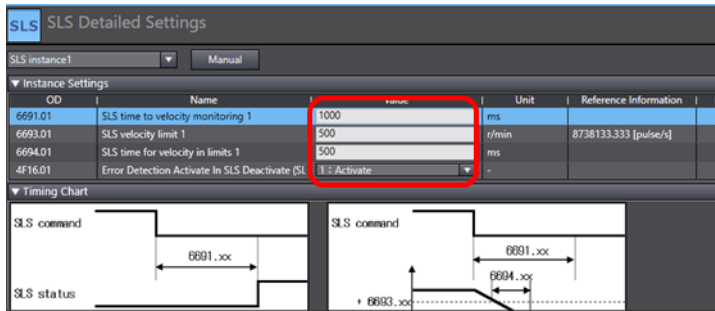

6. **Open the I/O Map and create device variables.**

Port	Variable name
SLS command1 Active for R88D-1SAN02H-ECT	E_Axis0_SLS_command1_Active
SLS command1 for R88D-1SAN02H-ECT	E_Axis0_SLS_command1

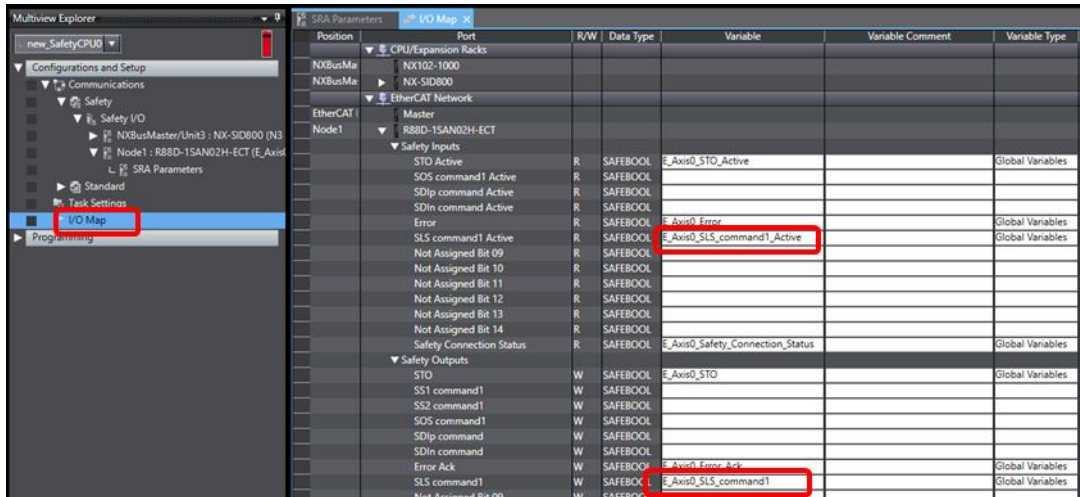

7. Create a safety program.

Add the following code to AutoProgram1.

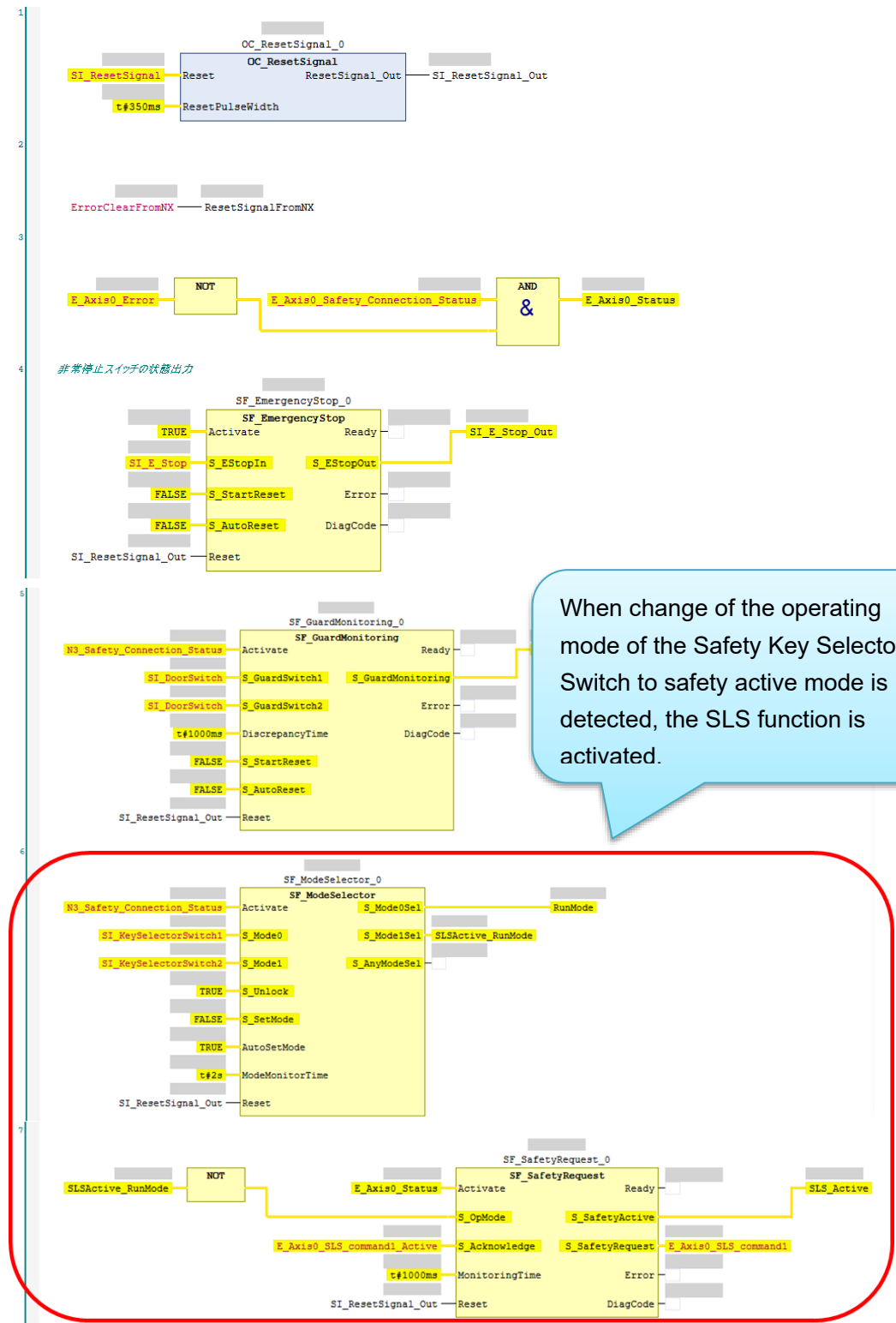

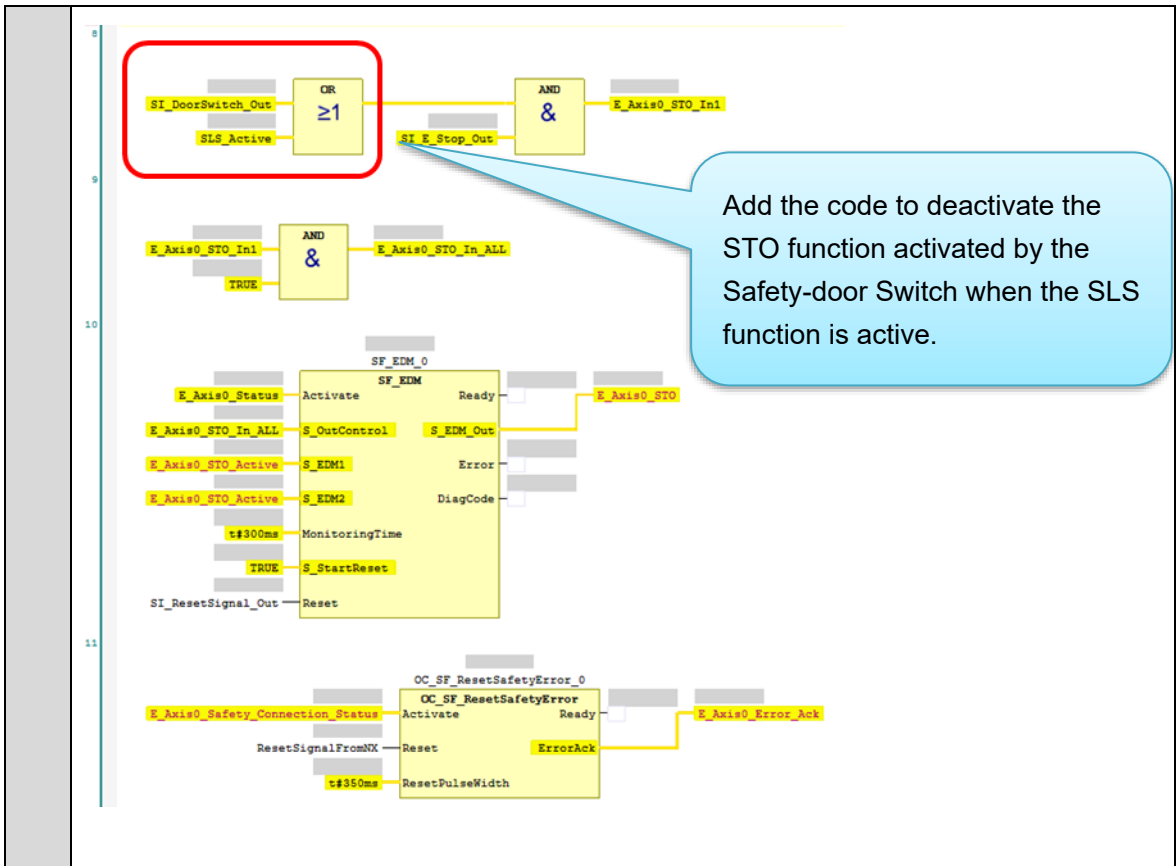

Add the code to deactivate the STO function activated by the Safety-door Switch when the SLS function is active.

■ Setting the Standard Controller

1. Select **new_Controller_0** from the list

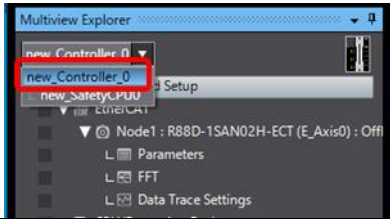

2. Double-click **I/O Map**.

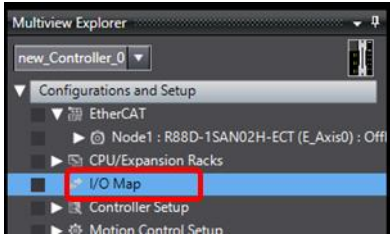

3. Create device variables.

Port	Variable name
SLS command 1 for R88D-1SAN02H-ECT	E_Axis0_SLS_command_1
SLS command 1 active for R88D-1SAN02H-ECT	E_Axis0_SLS_command_1_active

Position	Port	Description	R/W	Data Type	Variable	Variable Comment	Variable Type
Node1	R88D-1SAN02H-ECT	Controlword	W	WORD			
		Target position	W	DINT			
		Target velocity	W	DINT			
		Target torque	W	INT			
		Modes of operation	W	SINT			
		Touch probe function	W	WORD			
		Digital inputs	R	DWORD			
		Mirror Safety controlword	R	UINT			
		STO command	R	BOOL			
		SS1 command 1	R	BOOL			
		SS2 command 1	R	BOOL			
		SOS command 1	R	BOOL			
		Mirror Safety Controlword 4	R	BOOL			
		SDI positive direction command	R	BOOL			
		SDI negative direction command	R	BOOL			
		error acknowledge	R	BOOL			
		SLS command 1	R	BOOL	E_Axis0_SLS_command_1	Global Variables	
		Mirror Safety statusword	R	UINT			
		STO command active	R	BOOL	E_Axis0_STO_command_active	Global Variables	
		Mirror Safety Statusword 1	R	BOOL			
		Mirror Safety Statusword 2	R	BOOL			
		SOS command 1 active	R	BOOL			
		Mirror Safety Statusword 4	R	BOOL			
		SDI positive direction command active	R	BOOL			
		SDI negative direction command active	R	BOOL			
		error acknowledge active	R	BOOL			
		SLS command 1 active	R	BOOL	E_Axis0_SLS_command_1_active	Global Variables	

4. Create a standard program.

Add the code to change the command velocity.

- When the SLS function is active, reduce the command velocity to 60 r/min.
- When the SLS function is inactive, increase the command velocity to 600 r/min.

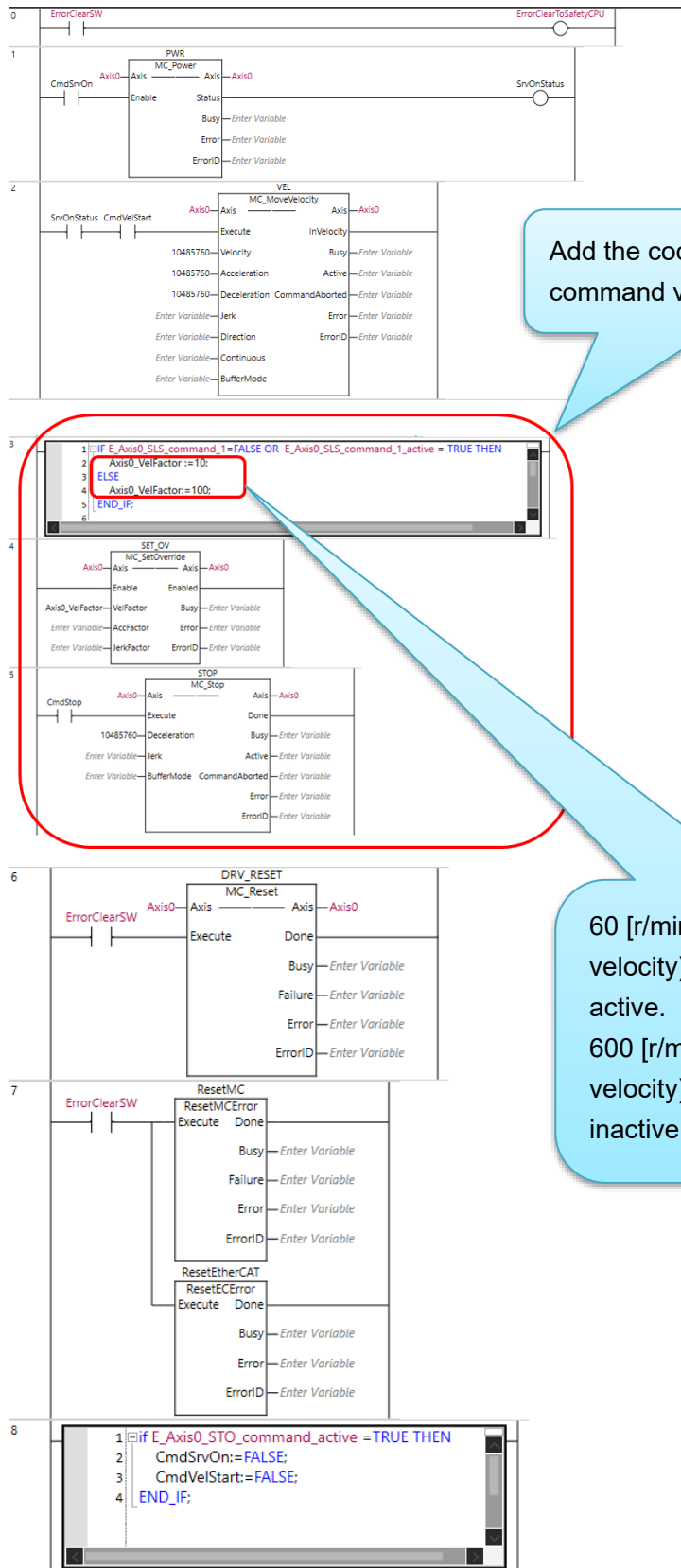

Add the code to change the command velocity here.

60 [r/min] (10% of command velocity) when the SLS function is active.
 600 [r/min] (100% of command velocity) when the SLS function is inactive.

5. **Transfer to the standard controller.**

Select *new_Controller_0* from the list.

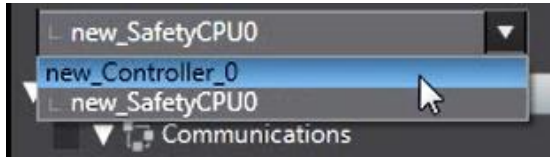

Connect to the standard controller.



Click the **Synchronization** Button to synchronize with the standard controller.



Transfer to the standard controller.

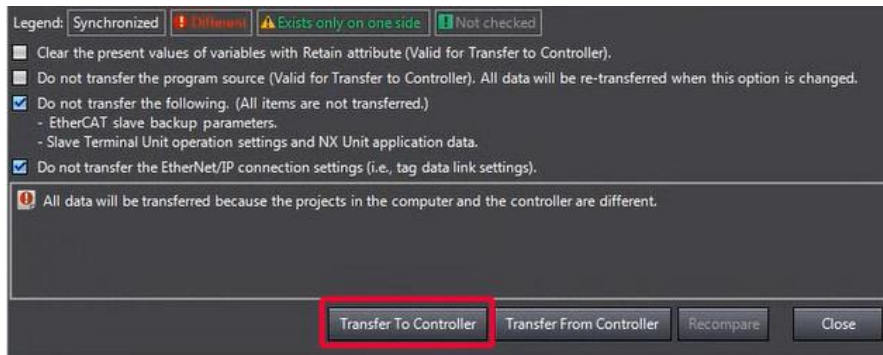

6. **Download the safety application.**

Select *new_SafetyCPU0* from the list.

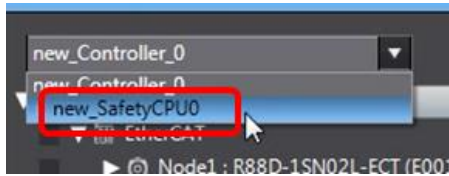

Click the **PROGRAM Mode** Button to switch to PROGRAM mode.

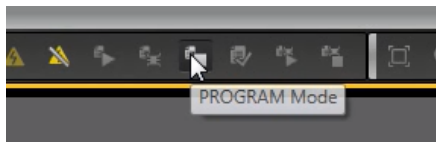

Click the **DEBUG Mode** Button to enter DEBUG mode.

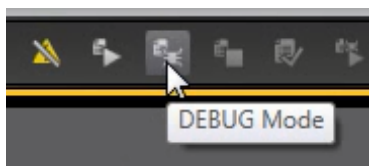

Click the **Start Debugging** Button to start DEBUG mode.

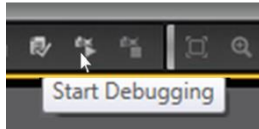

Click the **Safety Validation** Button.

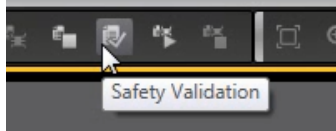

The safety application is now ready to run.

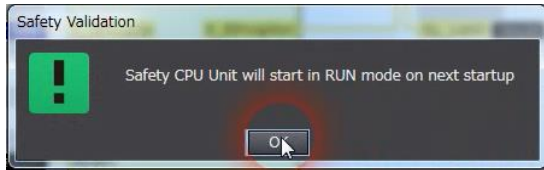

Click the **Run** Button.







7. **The FSoE communications are now established.**

The FS indicator is lit in green.

FS	Displays FSoE communications status.	Green	ON	FSoE slave connection established
			Flashing	FSoE slave connection establishment in progress
		Red	Flashing	Safety Parameter Error, Safety Communications Timeout, or other errors
		--	OFF	The safety functions are disabled by FSoE, the power is not supplied, or a fatal error including Self-diagnosis Error

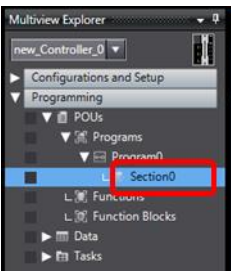
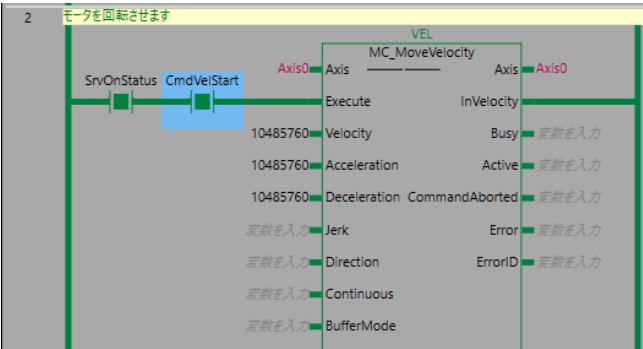
■ Checking Operation of the SLS Function

1.	<p>Check that the Safety Key Selector Switch is in normal operating mode.</p>  <p>The image shows a Safety Key Selector Switch. The switch is in the 'RUN' position, indicated by a red box around the 'RUN' label. The 'SAFETYACTIVE' label is also visible.</p>
2.	<p>Press the safety rest button.</p>  <p>The image shows a blue safety rest button.</p>
3.	<p>Double-click <i>Section0</i> to display the section.</p>  <p>The image is a screenshot of the Multiview Explorer software interface. The 'Section0' folder is highlighted with a red box.</p>
4.	<p>Right-click <i>CmdVelStart</i> and select <i>Set/Reset – Set</i>.</p>  <p>The image is a screenshot of the 'VEL' parameter configuration window. The 'CmdVelStart' parameter is highlighted with a blue box. The window shows various parameters for 'Axis0' such as Velocity, Acceleration, Deceleration, Jerk, Direction, Continuous, BufferMode, InVelocity, Busy, Active, CommandAborted, Error, and ErrorID.</p> <p>Check that the Servomotor rotates at about 600 r/min.</p>
5.	<p>Operate the Safety Key Selector Switch to switch to safety active mode.</p>  <p>The image shows the Safety Key Selector Switch in the 'SAFETYACTIVE' position, indicated by a red box around the 'SAFETYACTIVE' label. The 'RUN' label is also visible.</p> <p>Check that the Servomotor rotates at about 60 r/min. Check that the 7-segment LED display shows 'SF'.</p>  <p>The image shows a 7-segment LED display showing the characters 'SF'.</p>

6. **Open the guard with the Safety-door Switch.**



Check that the 7-segment LED display still shows 'SF'.

7. **Close the guard and press the safety reset switch.**

8. **Operate the Safety key Selector Switch to switch to normal operating mode.**



Check that the Servomotor rotates at about 600 r/min.

Check that the 7-segment LED display shows 'oE.'.



4.6. Adding the Safely-limited Position (SLP) Function

This section describes how to add the SLP function (*SOPT1 and SOPT2 Input in Safety Origin Position Determination Method*) to the project created in 3. *Performing Setup*.

Changes in System Configuration

Add the SOPT1 and SOPT2 input sensors.

NX-series NX1 CPU Unit

Additional I/O power supply

Digital Input Unit

NX-series Safety CPU Unit

NX-series Safety Input Unit

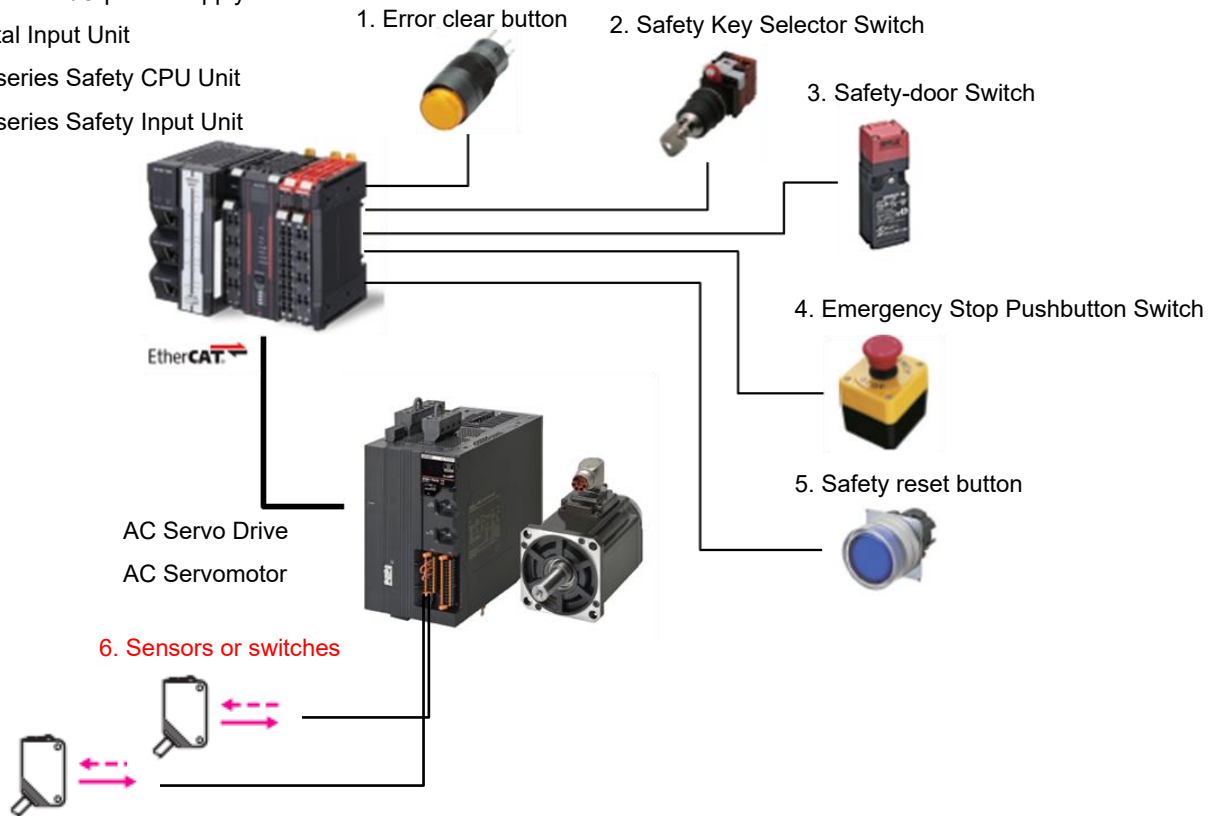

Changes in Wiring

1. Plug the wires for SOPT1 and SOPT2 into the Servo Drive. (CN14)

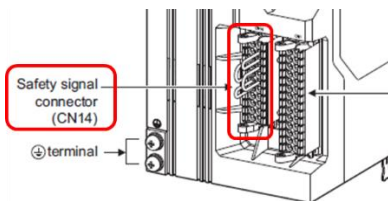

Safety I/O Signal Table

Pin No.	Symbol	Signal name	Pin No.	Symbol	Signal name
1	EDM-P	EDM- Output with short-circuit protection	12	EDM-	EDM- Output
2	EDM+	EDM+ Output without short-circuit protection	13	SFA	Reserved
3	SF1+	SF1+ Input	14	SF1+	SF1+ Input
4	SF1-	SF1- Input	15	SF1-	SF1- Input
5	SF2+	SF2+ Input	16	SF2+	SF2+ Input
6	SF2-	SF2- Input	17	SF2-	SF2- Input
7	SFB	Reserved	18	NC	Reserved
8	Y01	Test Output 1	19	Y02	Test Output 2
9	SOPT1	SOPT1 Input	20	SOPT2	SOPT2 Input
10	IOV	Test output 24-V power supply for SOPT input (+)	21	IOF	Test output 24-V power supply for SOPT input (-)
11	FG	FG	22	FG	FG

Connector for CN14 (22 Pins)

Model	Manufacturer	Omron model
DFMC1.5/11-ST-3.5-LRBK	PHOENIX CONTACT	R88A-CN1015 ¹⁾

¹⁾ Four short-circuit wires are connected to the connector.

Connection combinations:

3: SF1+ and 5: SF2+

6: SF2- and 7: SFB

13: SFA and 14: SF1+

15: SF1- and 17: SF2-

Applicable wire: AWG 24 to 16 (0.2 to 1.5 mm²) (Strip length of the wire insulating cover: 10 mm)

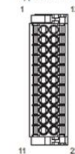

Note: Connectors at Servo Drives side include a pin to prevent improper connection.

The operation of the servo system set up in this section is explained below.

1. When the error clear button is pressed, the errors of the standard controller and Servo Drive are reset.
2. When the Safety Key Selector Switch is operated to switch to safety active mode, the Servo Drive activates the SLP function to monitor the Servomotor position. Before switching to safety active mode, you need to perform operation to limit the operating range (operation within the monitoring range) from the standard controller.
3. When the guard with the Safety-door Switch is opened while the SLP function is inactive, the motor torque is turned OFF.
4. When the Emergency Stop Pushbutton Switch is pressed, the motor torque is turned OFF.
5. When the safety reset button is pressed, the STO status is reset.

Input device	State	Operation
1. Error clear button	ON	Enable error reset command
	OFF	Disable error reset command
2. Safety Key Selector Switch	Normal operating mode	Deactivate SLP function.
	Safety active mode	Activate SLP function. When SLP position upper/lower limit range is exceeded, Servo Drive goes into STO state and Excessive Limit Value Error occurs.
3. Safety-door Switch	Open	SLP function deactivated: Enable STO command SLP function activated: Disable STO command
	Close	Disable STO command
4. Emergency Stop Pushbutton Switch	ON	Enable STO command
	OFF	Disable STO command
5. Safety reset button	ON	Enable reset STO status command
	OFF	Disable reset STO status command

■ Operation of SLP Function with Motion Control

1. When the Servo ON command is enabled, the Servo Drive turns ON the Servo.
2. When the origin determination command is enabled, the Servo Drive starts a safety origin determination operation. The Servomotor velocity recommended for origin determination operation is 200 r/min or less. Once the safety origin is determined, the Servo Drive sets it as the motion origin.
3. When the operation command is enabled, the Servomotor performs a reciprocating operation with a motor shaft travel distance of 4 rotations.
4. When the operation limit command is enabled, the Servomotor performs a reciprocating operation with a motor shaft travel distance of 2 rotations (within the SLP position upper/lower limit range).
5. When the SLP function is executed, the Servo Drive goes into the SLP state and monitors the position.
6. When the SLP function is released, the Servo Drive goes into the normal state.
7. When the operation limit command is disabled, the Servo Drive performs a reciprocating operation with a motor shaft travel distance of 4 rotations.

■ Procedure for Safety Origin Position Determination

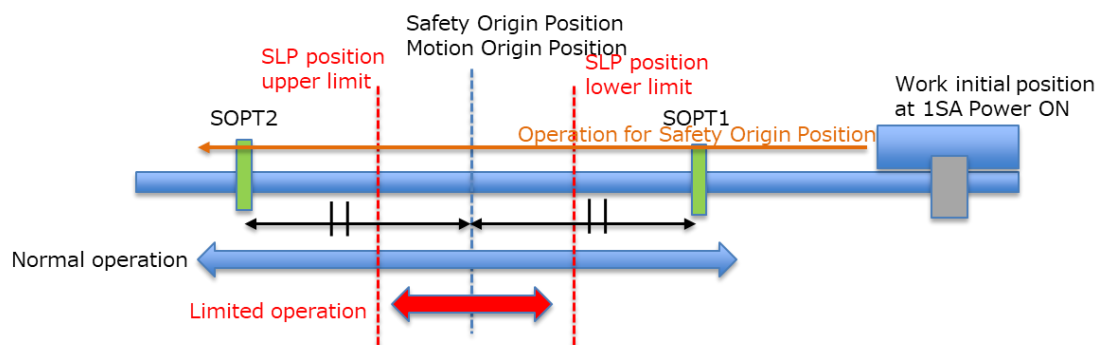

■ Safety Origin Determination Operation

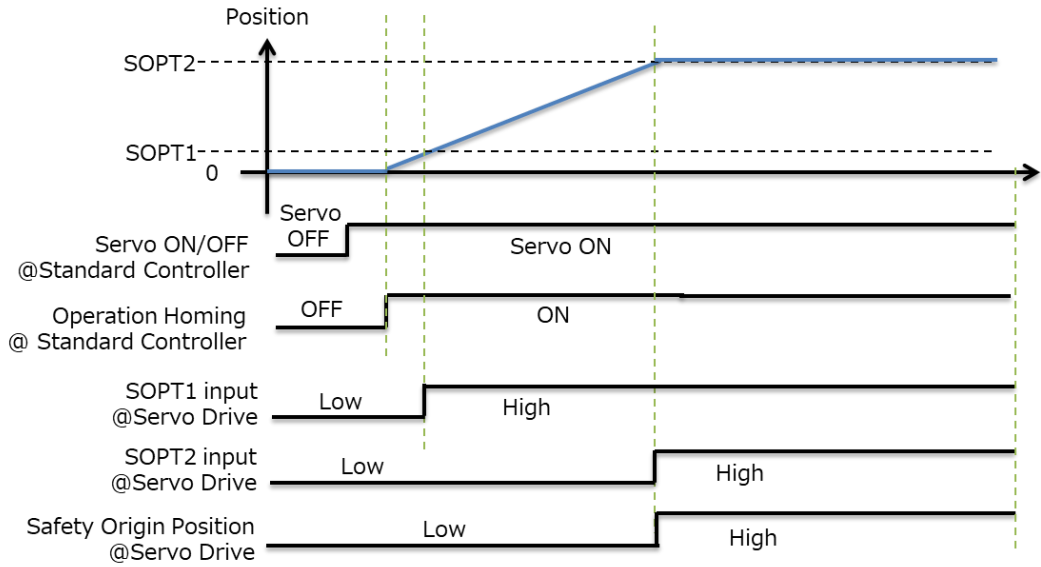

■ SLP Monitoring Operation

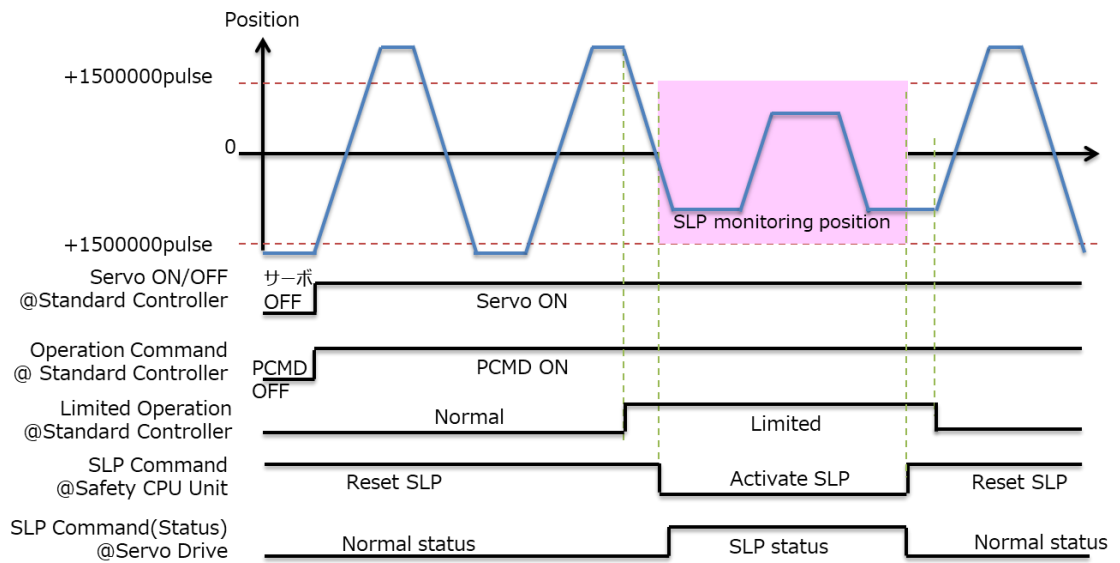

■ Setting the Safety Controller

1. Select *new_SafetyCPU0* from the list.

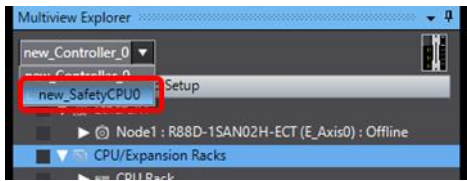

2. Click *SRA Parameters* and click the *Safety Function Assignment Settings* Button.

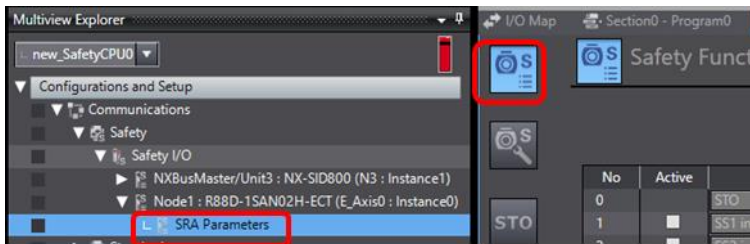

3. Assign the SLP function.

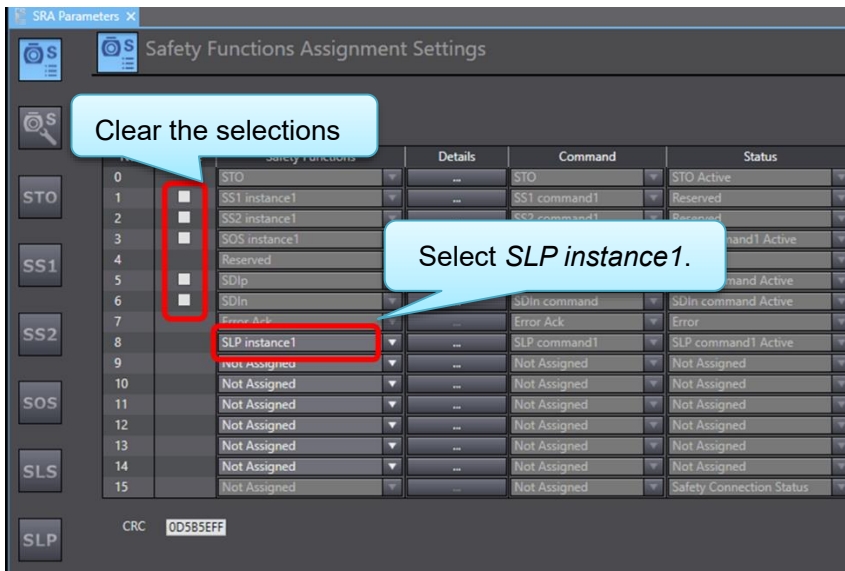

4. Click the **SLP** Button to display the SLP Detailed Settings view. You can also use the **...** Button to display the SLP Detailed Settings view.

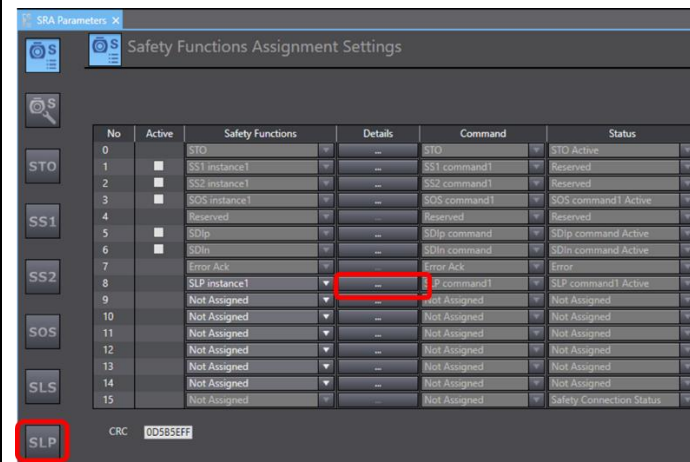

5. **Set SLP parameters.**

In this guide, set them as follows.

Name	Value	Unit
SLP position upper limit 1	1500000	EncoderUnit
SLP position lower limit 1	-1500000	EncoderUnit

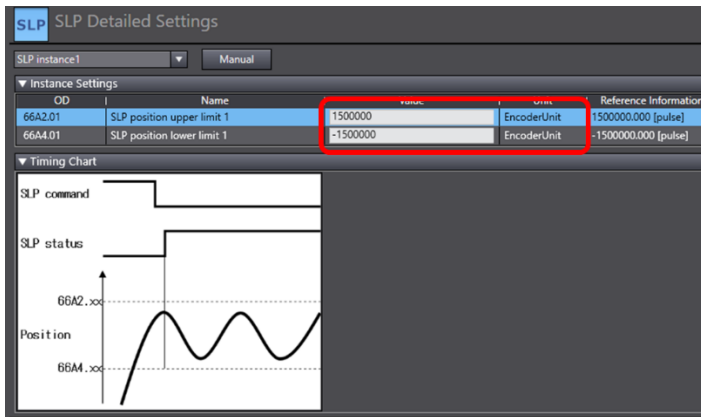

Set SLP common settings.

Name	Value	Unit
Safety Origin Position Determination Method	0: SOPT1 and SOPT2 Input	-
Safety Origin Position Offset	0	EncoderUnit
Test Pulse Diagnosis	0: Test pulse diagnosis of TO1 output is not enable / Test pulse diagnosis of TO2 output is not enable	-
SOPT Input Terminal Setting	0: SOPT1 input : Positive logic / SOPT2 input : Positive logic	-
Discrepancy Distance	667240	EncoderUnit
Safety Origin Position Tolerance	1048400	EncoderUnit

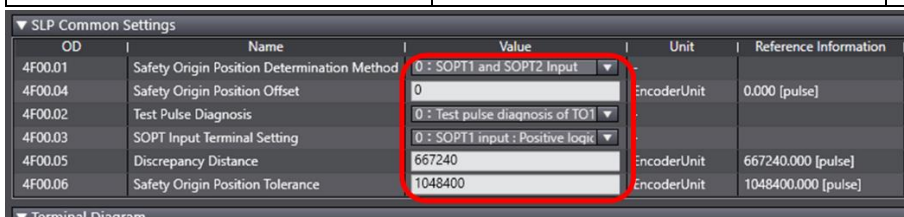

Procedure for Discrepancy Distance Setting

- 1) Set *Safety Origin Position Determination Method*, *Test Pulse diagnosis*, and *SOPT Input Terminal Setting* according to the sensor.
- 2) Set *Discrepancy Distance* to -1.
- 3) Set *Re-measurement of Discrepancy Distance Monitoring* to let a work carry out the behavior of origin determination shown in *Safety Origin Position Determination Method*.
- 4) Use the *Discrepancy Distance Monitor* to read the distance between the SOPTs.
- 5) After confirming the validity of this value, set *Discrepancy Distance* and *Safety Origin Position Tolerance*.

* Set the above values after thoroughly verifying that the device safety can be secured even if the safety origin position is shifted.

6. **Open the I/O Map and create device variables.**

Port	Variable name
SLP command1 Active for R88D-1SAN02H-ECT	E_Axis0_SLP_command1_Active
SLP command1 for R88D-1SAN02H-ECT	E_Axis0_SLP_command1

Position	Port	R/W	Data Type	Variable	Variable Comment	Variable Type
EtherCAT Master	Master					
Node1	R88D-1SAN02H-ECT					
	Safety Inputs					
	STO Active	R	SAFEROOL	E_Axis0_STO_Active		Global Variables
	SOS command1 Active	R	SAFEROOL			
	SDIp command Active	R	SAFEROOL			
	SDIn command Active	R	SAFEROOL			
	Error	R	SAFEROOL	E_Axis0_Error		Global Variables
	SLP command1 Active	R	SAFEROOL	E_Axis0_SLP_command1_Active		Global Variables
	Not Assigned Bit 09	R	SAFEROOL			
	Not Assigned Bit 10	R	SAFEROOL			
	Not Assigned Bit 11	R	SAFEROOL			
	Not Assigned Bit 12	R	SAFEROOL			
	Not Assigned Bit 13	R	SAFEROOL			
	Not Assigned Bit 14	R	SAFEROOL			
	Safety Connection Status	R	SAFEROOL	E_Axis0_Safety_Connection_Status		Global Variables
	Safety Outputs					
	STO	W	SAFEROOL	E_Axis0_STO		Global Variables
	SS1 command1	W	SAFEROOL			
	SS2 command1	W	SAFEROOL			
	SOS command1	W	SAFEROOL			
	SDIp command	W	SAFEROOL			
	SDIn command	W	SAFEROOL			
	Error Ack	W	SAFEROOL	E_Axis0_Error_Ack		Global Variables
	SLP command1	W	SAFEROOL	E_Axis0_SLP_command1		Global Variables
	Not Assigned Bit 00	W	SAFEROOL			

7.

Create a safety program.

Add the following code to AutoProgram1.

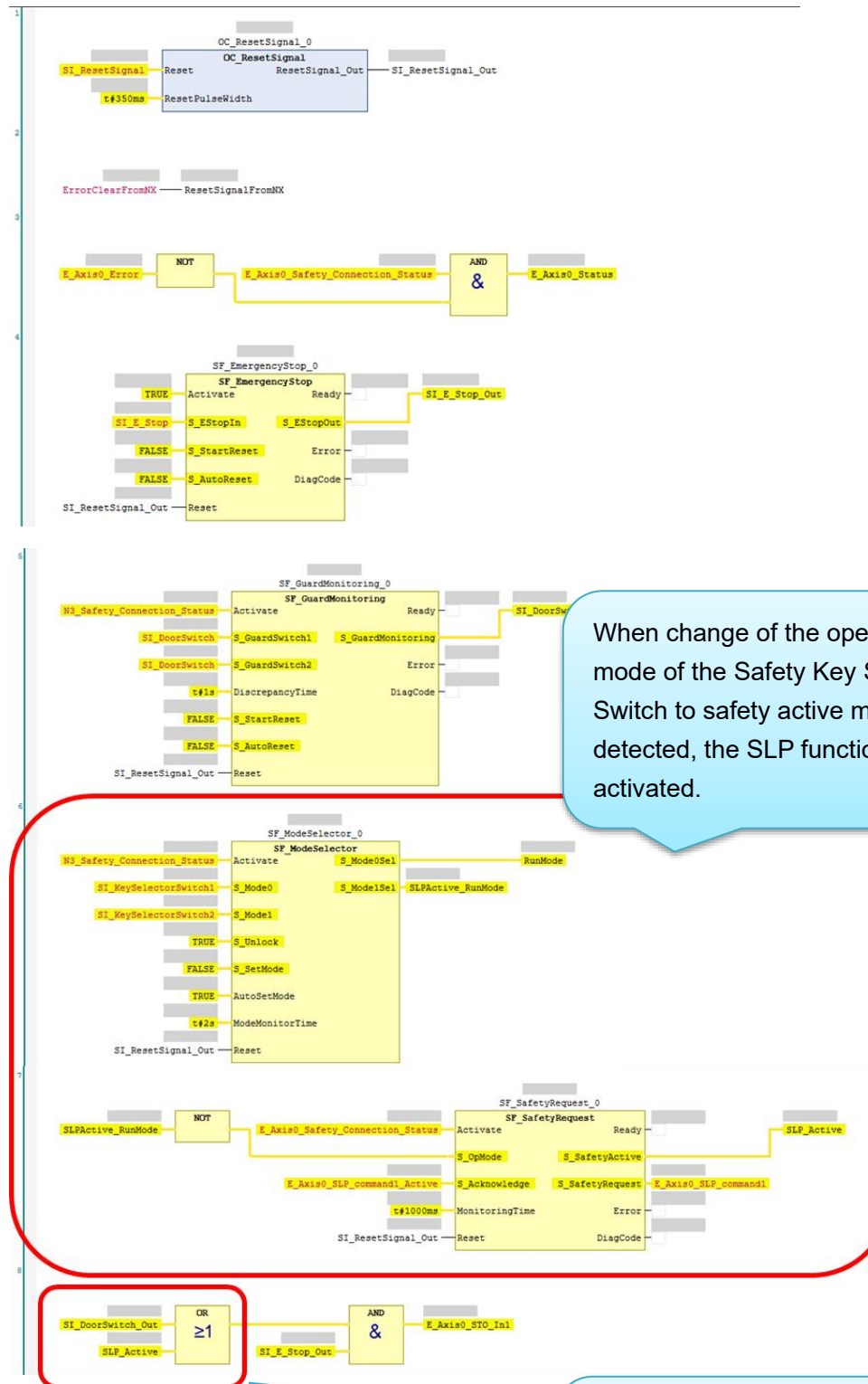

When change of the operating mode of the Safety Key Selector Switch to safety active mode is detected, the SLP function is activated.

Add the code to deactivate the STO function activated by the Safety-door Switch when the SLP function is activated.

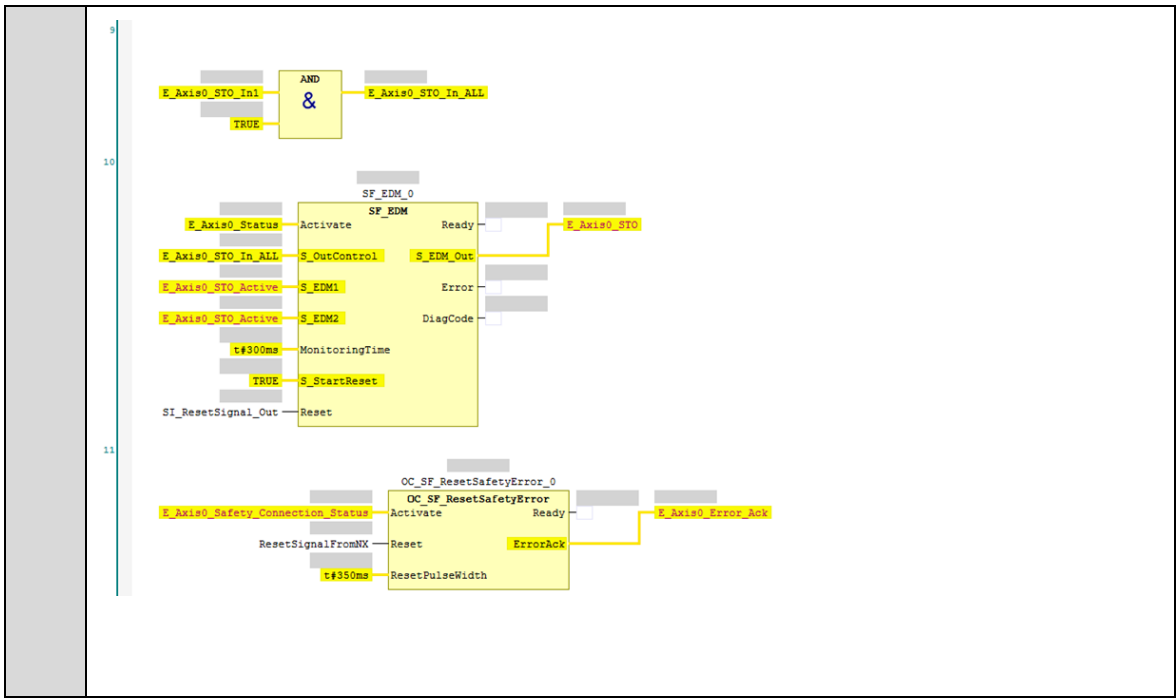

■ Setting the Standard Controller

1. Create code for the standard program.

Add the code to change the travel distance.

- When the operation limit command is enabled, set the travel distance to -1048576 to 1048576 (-1 to 1 rotation).
- When the operation limit command is disabled, set the travel distance to -2097152 to 2097152 (-2 to 2 rotations).

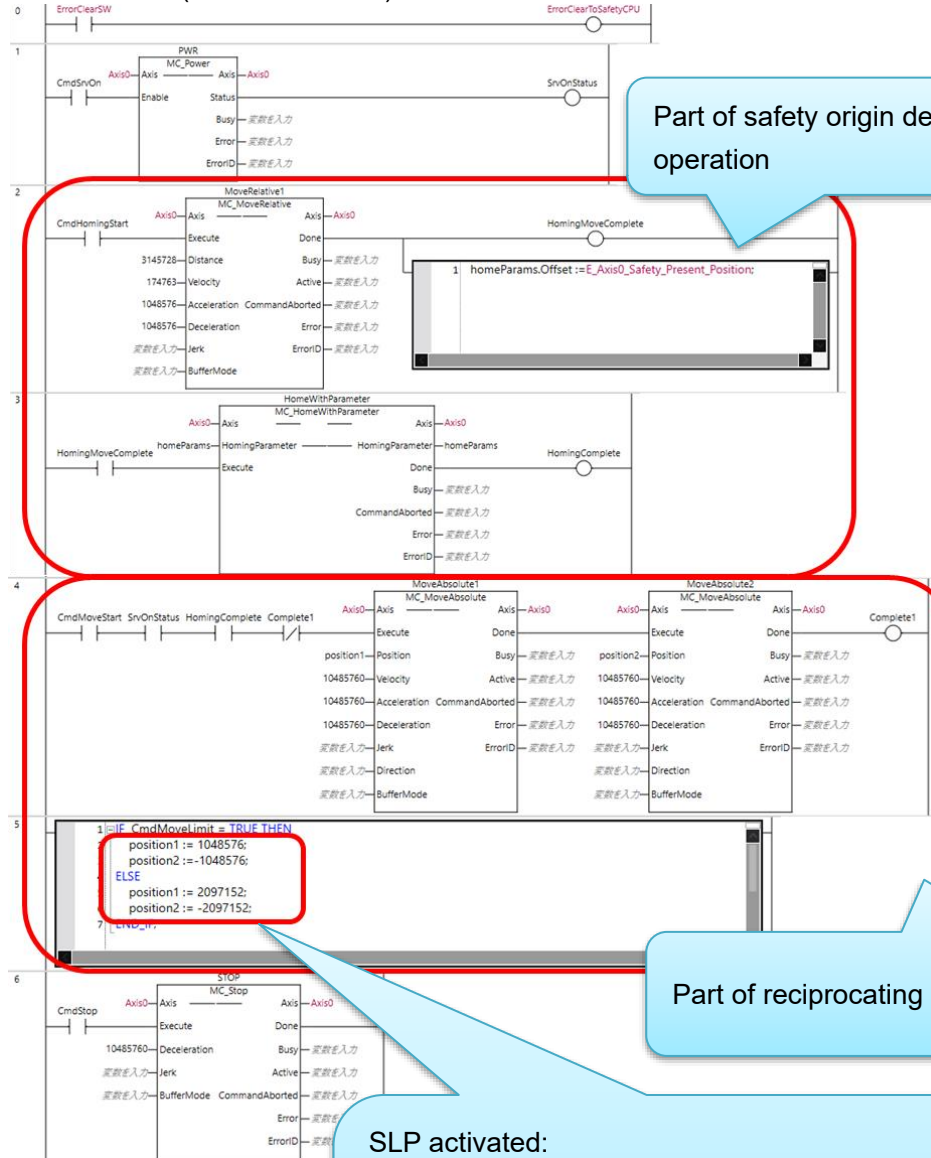

Part of safety origin determination operation

Part of reciprocating operation

SLP activated:
-1048576 to 1048576 (Reciprocating operation of -1 to 1 rotation)
SLP deactivated:
-2097152 to 2097152 (Reciprocating operation of -2 to 2 rotations)

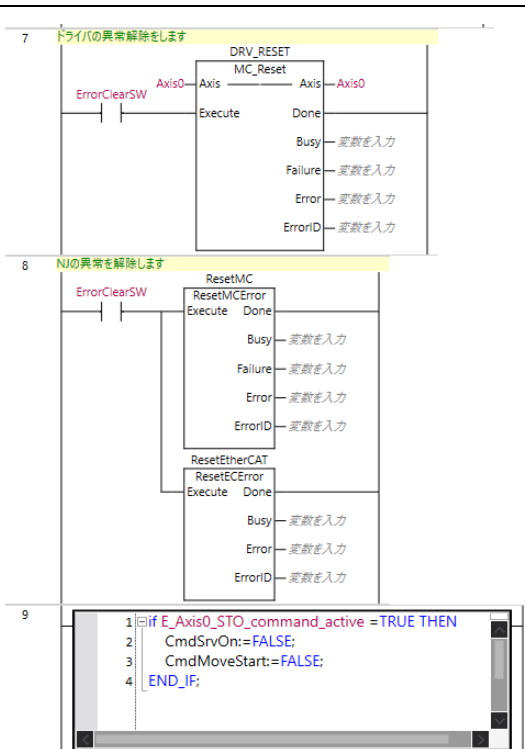

2. **Transfer to the standard controller.**

Select *new_Controller_0* from the list.

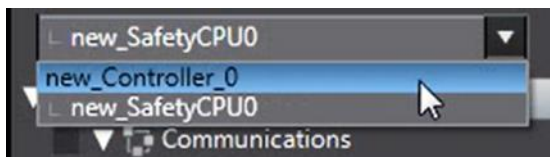

Connect to the standard controller.



Click the **Synchronization** Button to synchronize with the standard controller.



Transfer to the standard controller.

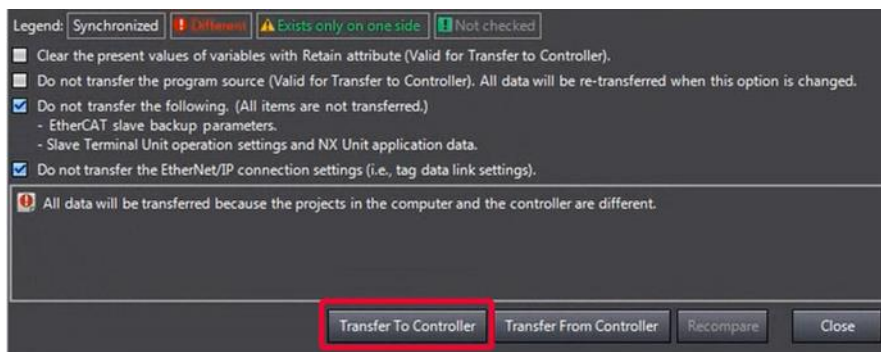

3. **Download the safety application.**

Select *new_SafetyCPU0* from the list.

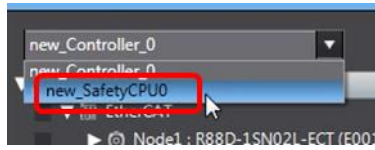

Click the **PROGRAM Mode** Button to switch to PROGRAM mode.



Click the **DEBUG Mode** Button to enter DEBUG mode.

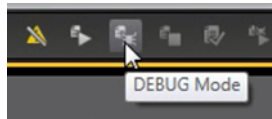

Click the **Start Debugging** Button to start DEBUG mode.

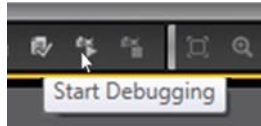

Click the **Safety Validation** Button.



Click the **OK** Button.

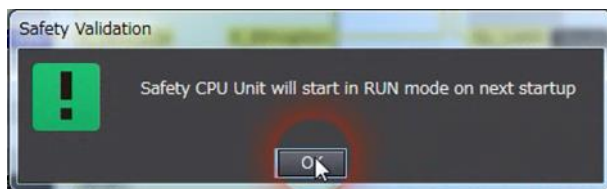

Click the **Run** Button.



4.

The FSoE communications are now established.

The FS indicator is lit in green.

FS	Displays FSoE communications status.	Green	ON	FSoE slave connection established
			Flashing	FSoE slave connection establishment in progress
		Red	Flashing	Safety Parameter Error, Safety Communications Timeout, or other errors
		---	OFF	The safety functions are disabled by FSoE, the power is not supplied, or a fatal error including Self-diagnosis Error

■ Checking Operation of the SLP Function

1. Check that the Safety Key Selector Switch is in normal operating mode.



2. Press the safety reset button.



3. Double-click *Section0* to display the section.



4. Right-click *CmdSrvOn* and select *Set/Reset – Set*.

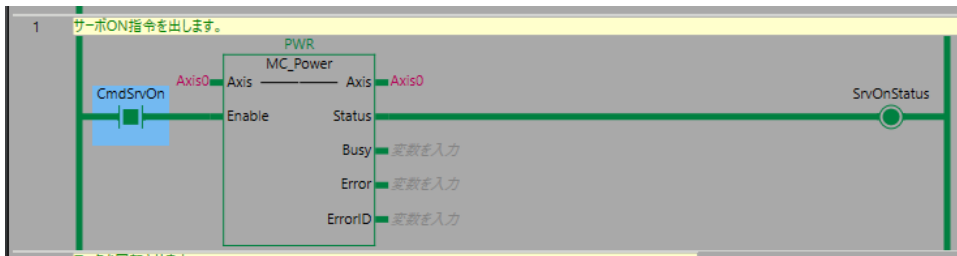

Check that the 7-segment LED display shows 'oE.'

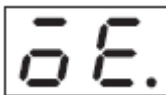

5. Right-click *CmdHomingStart* and select *Set/Reset – Set*.



Check that an origin determination operation starts and completes.

6. Right-click *CmdVelStart* and select *Set/Reset – Set*.

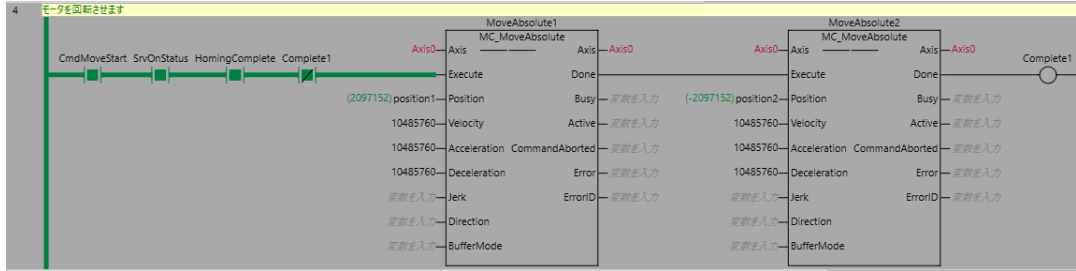

Confirm that the Servomotor performs a reciprocating operation with a motor shaft travel distance of 4 rotations.

7. When *CmdMoveLimit* is enabled (True), the Servomotor performs an operation with the travel distance limited (operation within the monitoring range).

```

5
1 IF CmdMoveLimit ▾ False = TRUE THEN
2   position1 ▶ 209 True False = 1048576;
3   position2 ▶ -2097152 := -1048576;
4 ELSE
5   position1 ▶ 2097152 := 2097152;
6   position2 ▶ -2097152 := -2097152;
7 END_IF;

```

Confirm that the Servomotor performs a reciprocating operation with a motor shaft travel distance of 2 rotations.

8. Operate the Safety Key Selector Switch to switch to safety active mode.



Check that the 7-segment LED display shows 'SF'.

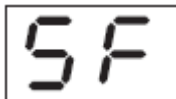



9. Open the guard with the Safety-door Switch.



Check that the 7-segment LED display still shows 'SF'.



10. Close the guard and press the safety reset switch.

11.	<p>Operate the Safety key Selector Switch to switch to normal operating mode.</p>  <p>Check that the 7-segment LED display shows 'oE.'.</p> 
12.	<p>When <i>CmdMoveLimit</i> is disabled (False), the Servomotor performs an operation based on the original travel distance.</p> <p>Confirm that the Servomotor performs a reciprocating operation with a motor shaft travel distance of 4 rotations.</p>

■ **Procedure for Recovery from an Excessive Limit Value Error (Er.71.03)**

If the motor position goes out of the SLP monitoring range during SLP monitoring, an Excessive Limit Value Error (Er.71.03) occurs.

Use the following procedure to reset the Excessive Limit Value Error (Er.71.03) and move the motor position into the SLP monitoring range.

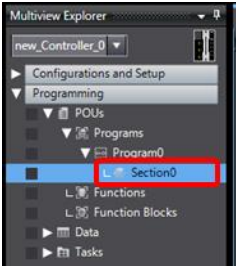
1.	<p>Operate the Safety key Selector Switch to switch to normal operating mode.</p> 
2.	<p>Press the safety reset button.</p> 
3.	<p>Press the error clear button twice.</p> 
4.	<p>Double-click <i>Section0</i> to display the section.</p> 

5. Right-click *CmdSrvOn* and select *Set/Reset – Set*.

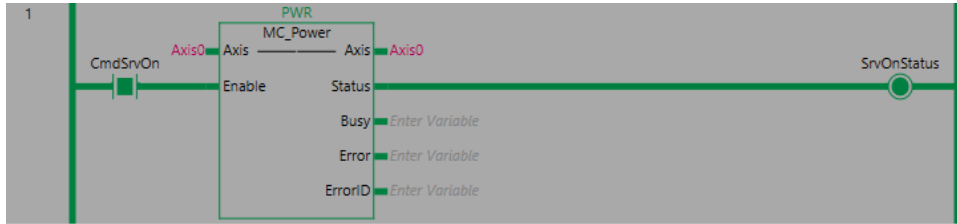

Check that the 7-segment LED display shows 'oE.'



6. Right-click *CmdHomingStart* and select *Set/Reset – Set*.

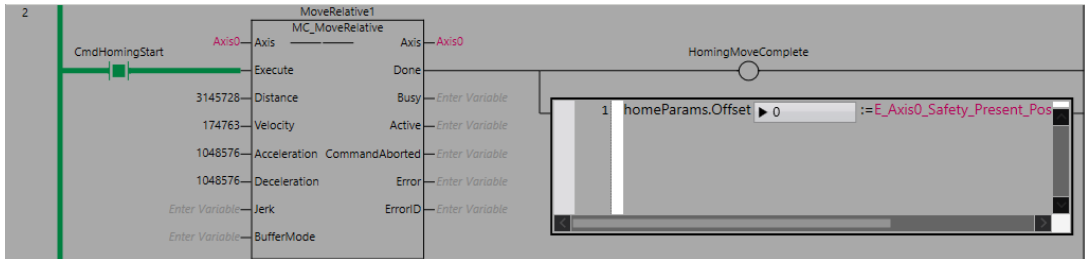

Check that an origin determination operation starts and completes.

7. Right-click *CmdVe/Start* and select *Set/Reset – Set*.

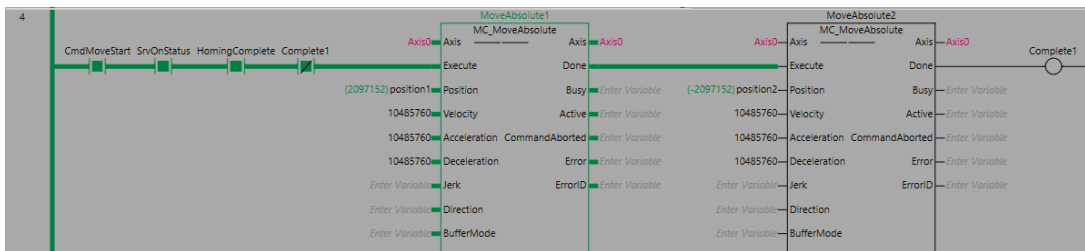

Confirm that the Servomotor performs a reciprocating operation with a motor shaft travel distance of 4 rotations.

8. When *CmdMoveLimit* is enabled (True), the Servomotor performs an operation with the travel distance limited (operation within the monitoring range).

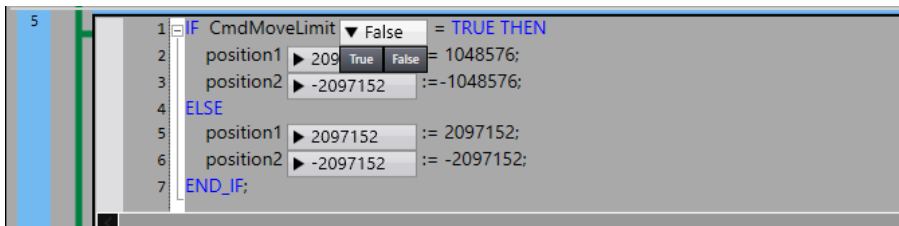

Confirm that the Servomotor performs a reciprocating operation with a motor shaft travel distance of 2 rotations.

4.7. Adding the Safe Direction (SDI) Function

This section describes how to add the SDI function to the project created in 3. *Performing Setup*. The SDI function monitors that a Servomotor is not operating toward a prohibited rotation direction.

To monitor that a motor axis is rotating in the positive direction: SDI negative direction command (SDIn)

To monitor that a motor axis is rotating in the negative direction: SDI positive direction command (SDIp)

The operation of the servo system set up in this section is explained below.

1. When the error clear button is pressed, the errors of the standard controller and Servo Drive are reset.
2. When the Safety Key Selector Switch is operated to switch to safety active mode, the Servo Drive activates the SDI function to monitor the Servomotor rotation direction.
3. When the guard with the Safety-door Switch is opened while the SDI function is inactive, the motor torque is turned OFF.
4. When the Emergency Stop Pushbutton Switch is pressed, the motor torque is turned OFF.
5. When the safety reset button is pressed, the STO status is reset.

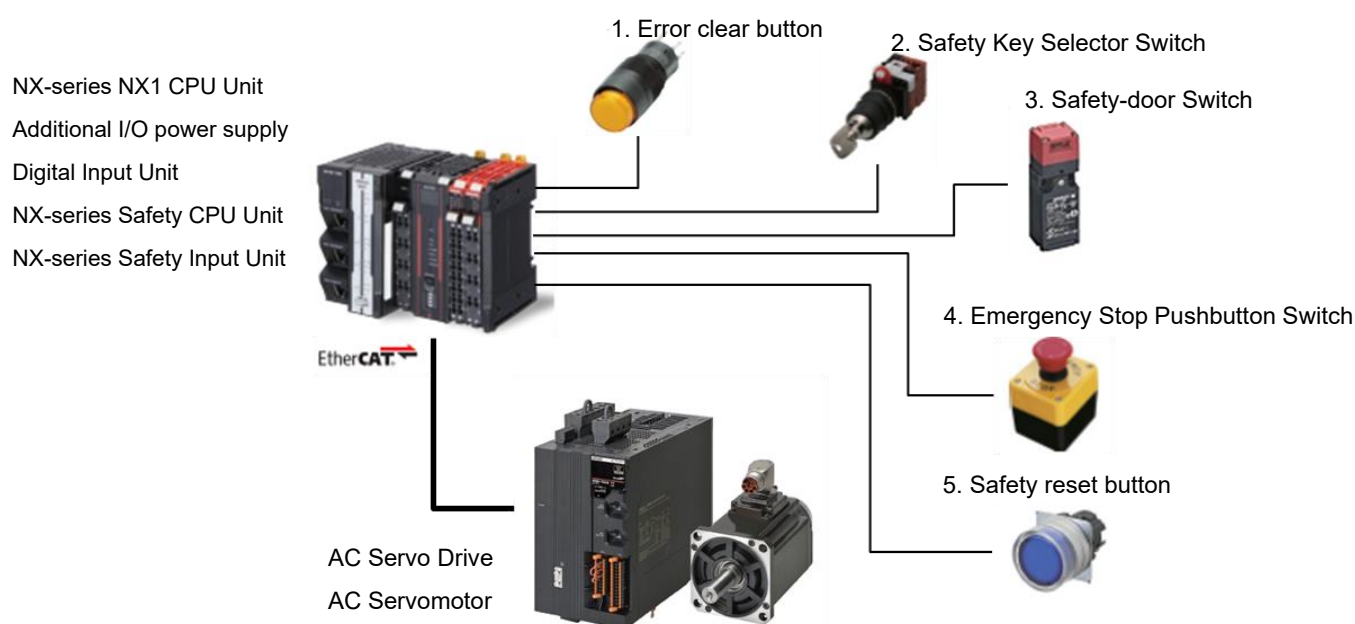

Input device	State	Operation
1. Error clear button	ON	Enable error reset command
	OFF	Disable error reset command
2. Safety Key Selector Switch	Normal operating mode	Deactivate SDIn function.
	Safety active mode	Activate SDIn function. When velocity zero window is exceeded, or position zero window is exceeded from stop position, Servo Drive goes into STO state and Excessive Limit Value Error occurs.

3. Safety-door Switch	Open	SDIn function deactivated: Enable STO command SDIn function activated: Disable STO command
	Close	Disable STO command
4. Emergency Stop Pushbutton Switch	ON	Enable STO command
	OFF	Disable STO command
5. Safety reset button	ON	Enable reset STO status command
	OFF	Disable reset STO status command

□ Operation of SDI Function with Motion Control

1. When the Servo ON command is enabled, the Servo Drive turns ON the Servo.
2. When an operation command is enabled, the command velocity to the Servomotor is set to 600 r/min.
3. When the SDIn function is executed, the Servo Drive goes into the SDIn active state and monitors the rotation direction and position zero window.
4. When the SDIn function is released, the Servo Drive goes into the normal state. The monitoring of the motor velocity stops.

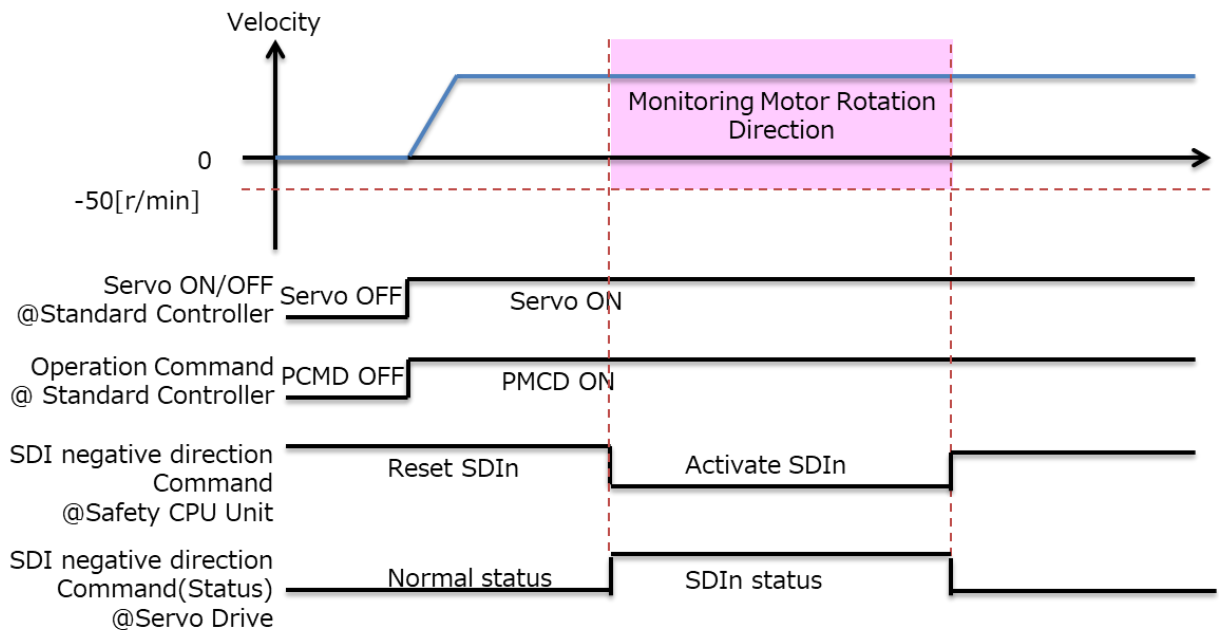

■ Setting the Safety Controller

1. Select *new_SafetyCPU0* from the list.

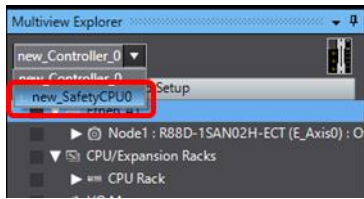

2. Click *SRA Parameters* and click the *Safety Function Assignment Settings* Button.

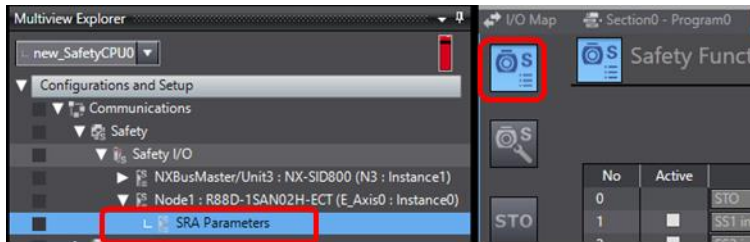

3. Assign the SDIn function.

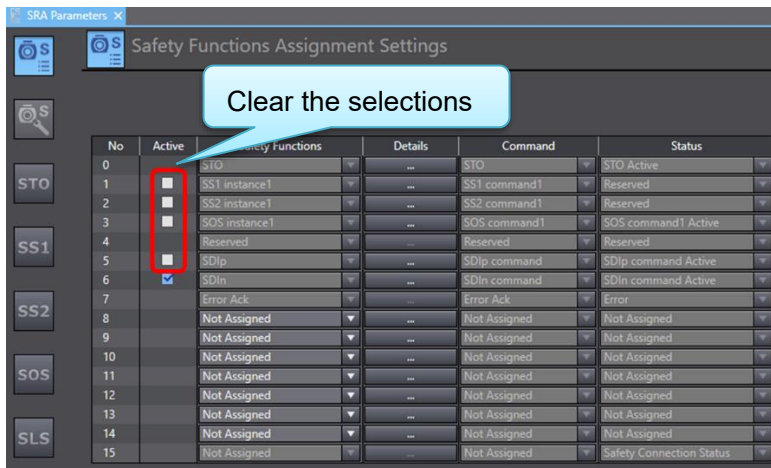

4. Click the **SDI** Button to display the SDI Detailed Settings view.

You can also use the **...** Button to display the SDI Detailed Settings view.

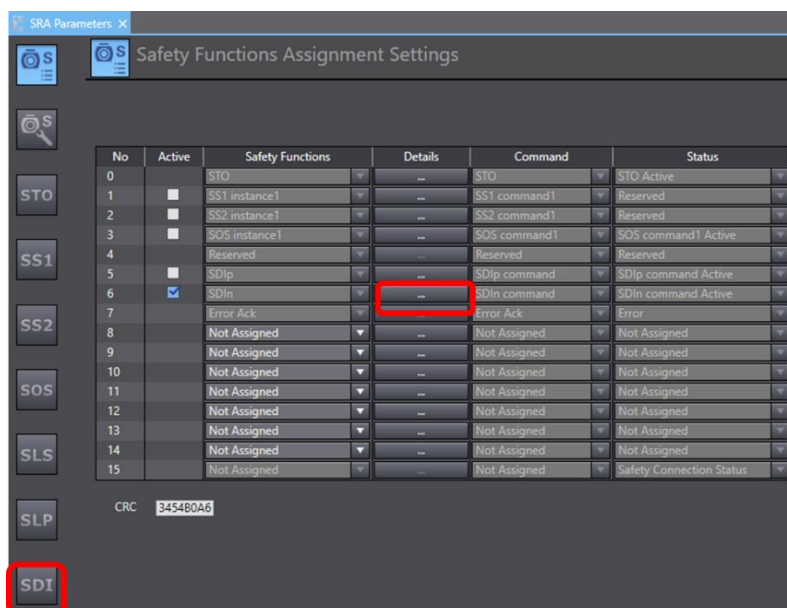

5. **Set SDI parameters.**

In this guide, set them as follows.

Name	Value	Unit
SDI position zero window	131072	EncoderUnit
SDI velocity zero window	50	r/min

The screenshot shows the 'SDI Detailed Settings' window. Under 'Instance Settings', the following parameters are configured:

OD	Name	Value	Unit	Reference Information
66D3.00	SDI position zero window	131072	EncoderUnit	131072.000 [pulse]
66D5.00	SDI velocity zero window	50	r/min	873813.333 [pulse/s]

The 'Timing Chart' section displays two graphs. The left graph, 'SDIp command', shows speed and position waveforms with a zero-crossing point at 6603.xx. The right graph, 'SDIn command', shows similar waveforms with a zero-crossing point at 6603.xx.

6. **Open the I/O Map and create device variables.**

Port	Variable name
SDIn command for R88D-1SAN02H-ECT	E_Axis0_SDI_command1

The screenshot shows the 'I/O Map' window for the R88D-1SAN02H-ECT device. The 'I/O Map' tab is selected, and the following variables are listed:

Position	Port	R/W	Data Type	Variable	Variable Comment	Variable Type
	STO Active	R	SAFEBOOL	E_Axis0_STO_Active		Global Variables
	SOS command1 Active	R	SAFEBOOL			
	SDIp command Active	R	SAFEBOOL			
	SDIn command Active	R	SAFEBOOL			
	Error	R	SAFEBOOL	E_Axis0_Error		Global Variables
	Not Assigned Bit 08	R	SAFEBOOL			
	Not Assigned Bit 09	R	SAFEBOOL			
	Not Assigned Bit 10	R	SAFEBOOL			
	Not Assigned Bit 11	R	SAFEBOOL			
	Not Assigned Bit 12	R	SAFEBOOL			
	Not Assigned Bit 13	R	SAFEBOOL			
	Not Assigned Bit 14	R	SAFEBOOL			
	Safety Connection Status	R	SAFEBOOL	E_Axis0_Safety_Connection_Status		Global Variables
	STO	W	SAFEBOOL	E_Axis0_STO		Global Variables
	SS1 command1	W	SAFEBOOL			
	SS2 command1	W	SAFEBOOL			
	SOS command1	W	SAFEBOOL			
	SDIp command	W	SAFEBOOL			
	SDIn command	W	SAFEBOOL	E_Axis0_SDI_command		Global Variables
	Error Ack	W	SAFEBOOL	E_Axis0_Error_Ack		Global Variables
	Not Assigned Bit 08	W	SAFEBOOL			

7.

Create a safety program.

Add the following code to AutoProgram1.

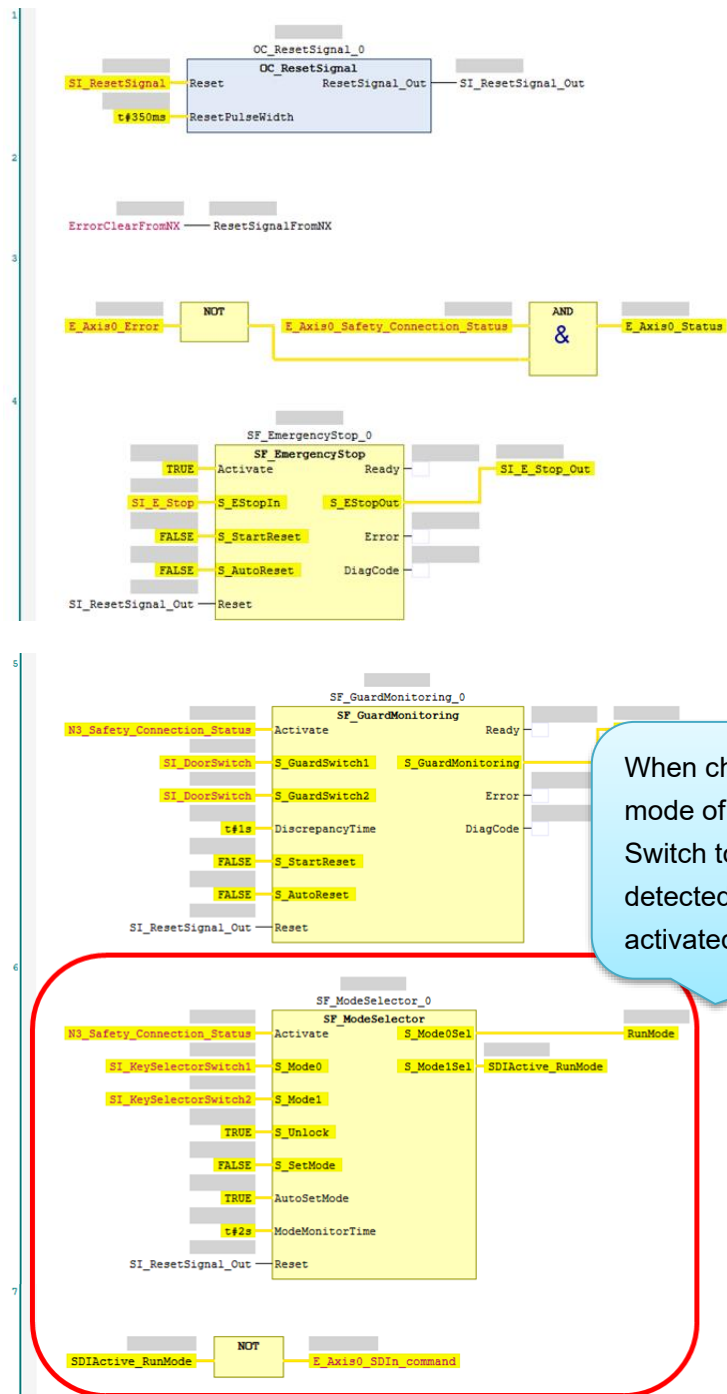

When change of the operating mode of the Safety Key Selector Switch to safety active mode is detected, the SDI function is activated.

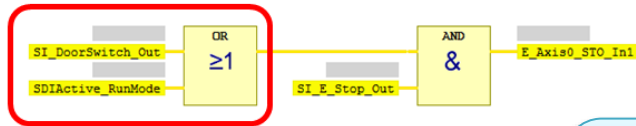

Add the code to deactivate the STO function activated by the Safety-door Switch when the SDI function is activated.

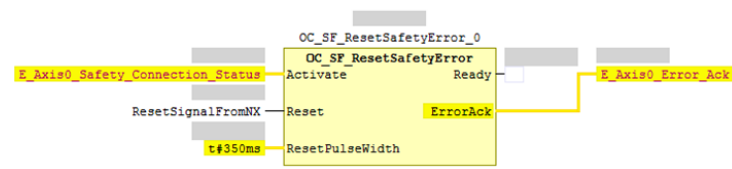
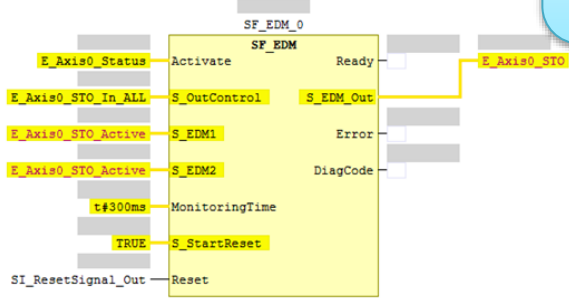
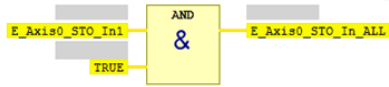

■ Setting the Standard Controller

1. The program is the same as that of the STO function. For further details, refer to **3.6 Creating a Motor Control Program**. Confirm that the program is as follows.

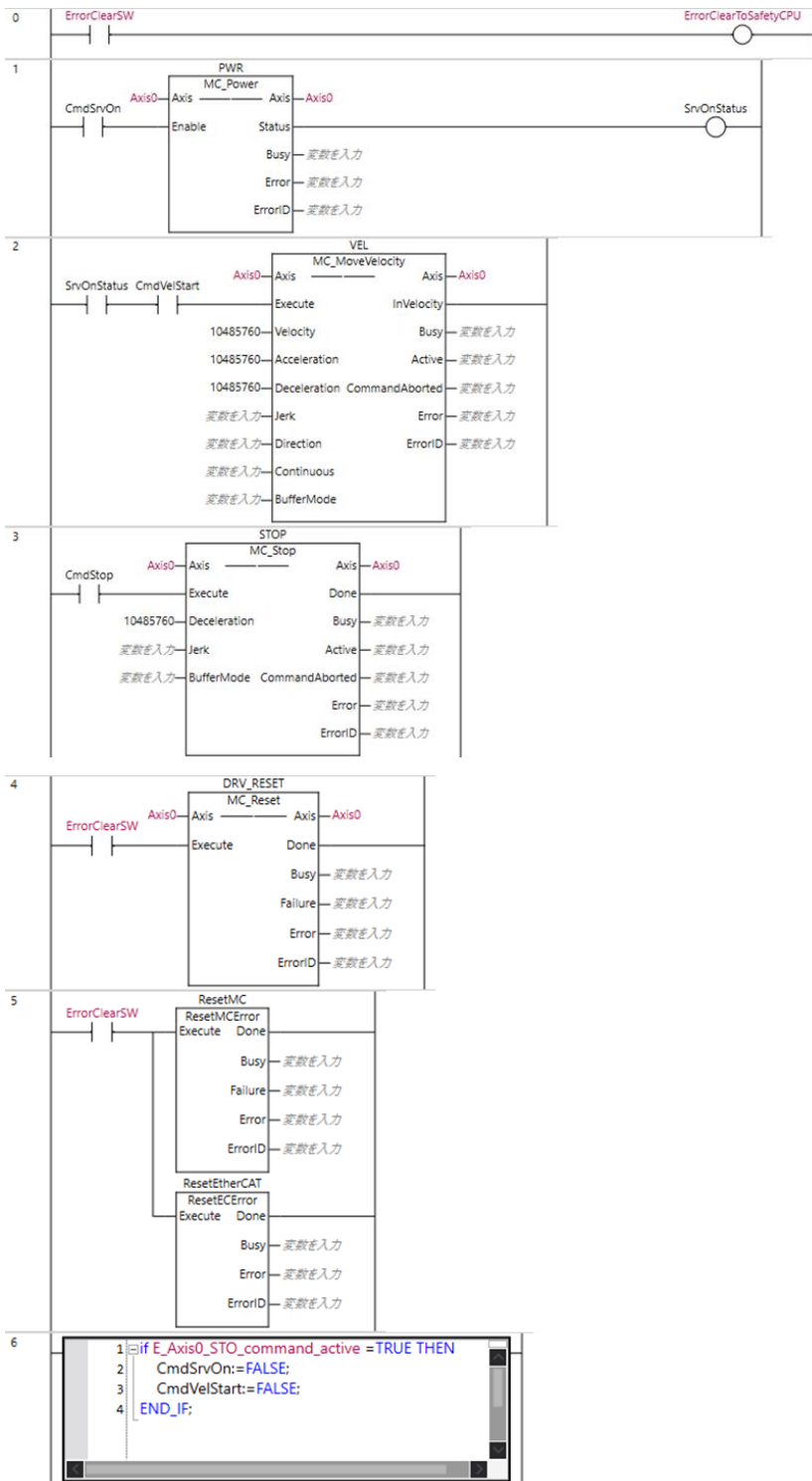

2. **Transfer to the standard controller.**

Select *new_Controller_0* from the list.

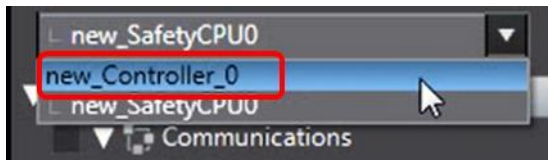

Connect to the standard controller.



Click the **Synchronization** Button to synchronize with the standard controller.



Transfer to the standard controller.

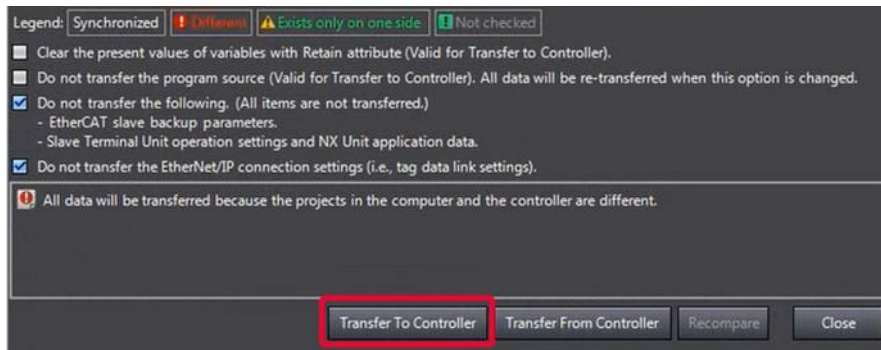

3. **Download the safety application.**

Select *new_SafetyCPU0* from the list.

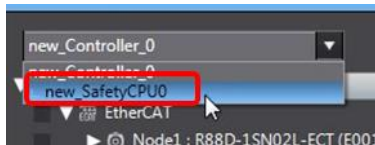

Click the **PROGRAM Mode** Button to switch to PROGRAM mode.

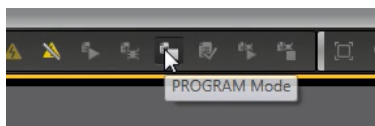

Click the **DEBUG Mode** Button to enter DEBUG mode.



Click the **Start Debugging** Button to start DEBUG mode.



Click the **Safety Validation** Button.



Click the **OK** Button.

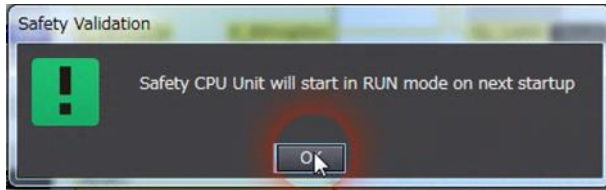

Click the **Run** Button.





4. **The FSoE communications are now established.**

The FS indicator is lit in green.

FS	Displays FSoE communications status.	Green	ON	FSoE slave connection established
			Flashing	FSoE slave connection establishment in progress
		Red	Flashing	Safety Parameter Error, Safety Communications Timeout, or other errors
		--	OFF	The safety functions are disabled by FSoE, the power is not supplied, or a fatal error including Self-diagnosis Error

■ Checking Operation of the SDI Function

1. **Check that the Safety Key Selector Switch is in normal operating mode.**

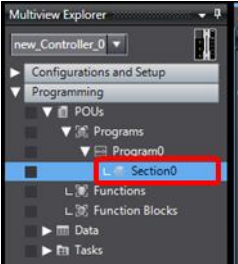

The image shows a red safety key selector switch. To its right, a circular indicator has 'SAFETYACTIVE' on the left and 'RUN' on the right. The 'RUN' indicator is highlighted with a red box, indicating the switch is in normal operating mode.
2. **Press the safety reset button.**

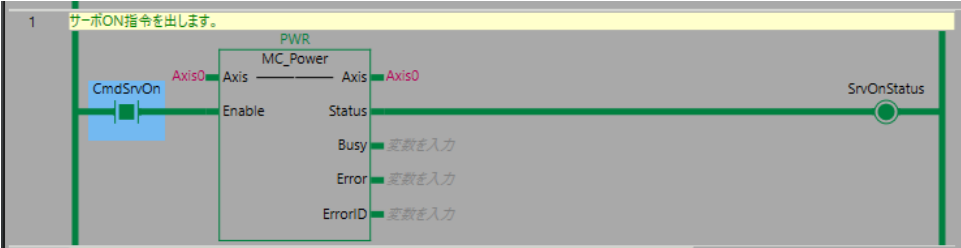
The image shows a blue safety reset button with a white center.
3. **Double-click *Section0* to display the section.**

The image shows a software interface window titled 'Multiview Explorer'. Under the 'Program0' folder, 'Section0' is selected and highlighted with a red box.
4. **Right-click *CmdSrvOn* and select *Set/Reset – Set*.**

The image shows a ladder logic diagram for the 'PWR' block. The 'CmdSrvOn' input is set to 'Set'. The 'SrvOnStatus' output is shown as a green circle.



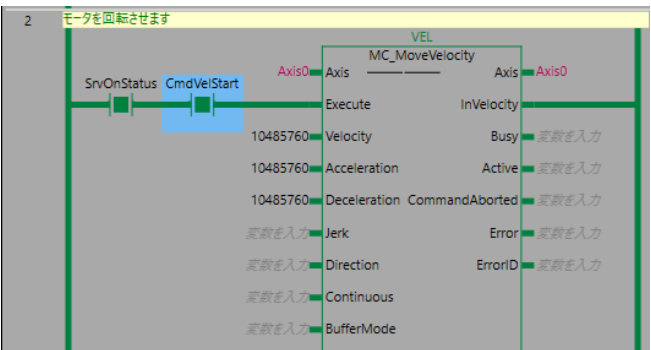

Check that the 7-segment LED display shows 'oE.'.



The image shows a 7-segment LED display with the characters 'oE.' displayed.
5. **Right-click *CmdVelStart* and select *Set/Reset – Set*.**

The image shows a ladder logic diagram for the 'VEL' block. The 'CmdVelStart' input is set to 'Set'. The 'SrvOnStatus' output is shown as a green circle.

Check that the Servomotor rotates at about 600 r/min.

6.	<p>Operate the Safety Key Selector Switch to switch to safety active mode.</p>  <p>The image shows a red and black Safety Key Selector Switch. To its right is a circular selector switch with two positions: 'SAFETYACTIVE' (highlighted with a red box) and 'RUN'.</p> <p>Check that the 7-segment LED display shows 'SF'.</p> 
7.	<p>Open the guard with the Safety-door Switch.</p>  <p>The image shows a red Safety-door Switch and a metal guard mechanism with a handle.</p> <p>Check that the 7-segment LED display still shows 'SF'.</p>
8.	<p>Close the guard and press the safety reset switch.</p>
9.	<p>Operate the Safety Key Selector Switch to switch to normal operating mode.</p>  <p>The image shows the same Safety Key Selector Switch. To its right is the circular selector switch with 'SAFETYACTIVE' and 'RUN' (highlighted with a red box) positions.</p> <p>Check that the 7-segment LED display shows 'oE'.</p> 

4.8. Adding Multiple Safety Functions (SS2 + SLS)

This section describes how to add the SS2 and SLS functions to the project created in 3. *Performing Setup*.

The operation of the servo system set up in this section is explained below.

1. When the error clear button is pressed, the errors of the standard controller and Servo Drive are reset.
2. When the Safety-door Switch is opened, the standard controller lets the Servomotor decelerate to a stop. The Servo Drive activates the SS2 and SLS functions and monitors the motor position and velocity.
3. When the Safety Key Selector Switch is operated to switch to safety inactive mode, the standard controller changes the velocity command value to low speed. The Servo Drive deactivates the SS2 function.
4. When the Emergency Stop Pushbutton Switch is pressed, the motor torque is turned OFF.
5. When the safety reset button is pressed, the STO status is reset.

NX-series NX1 CPU Unit

Additional I/O power supply

Digital Input Unit

NX-series Safety CPU Unit

NX-series Safety Input Unit

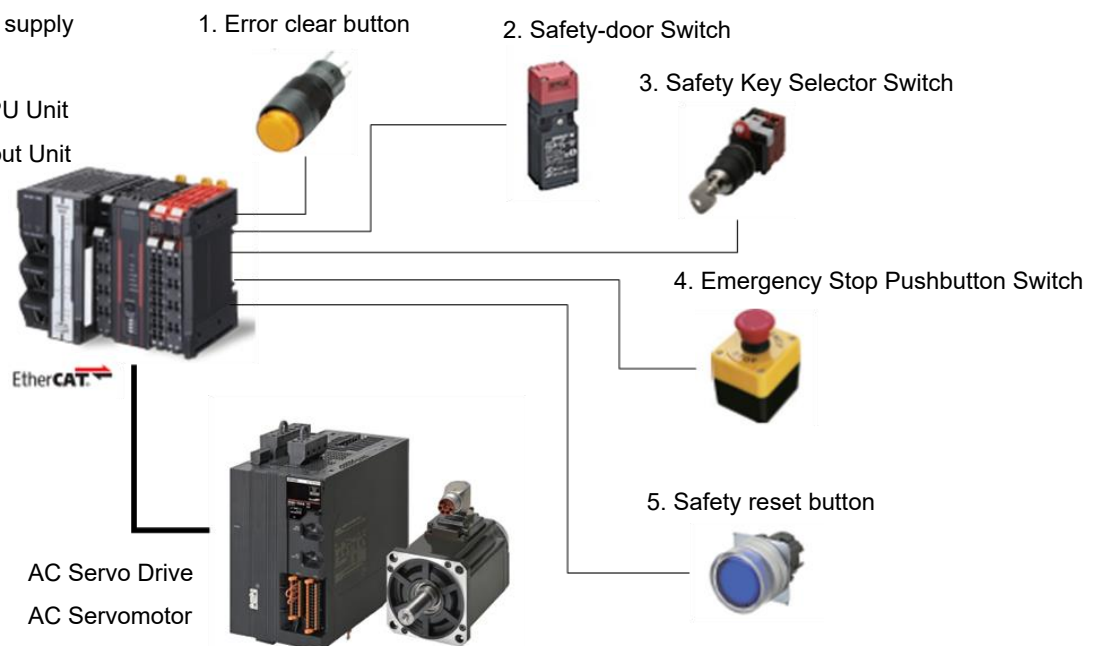

Input device	State	Operation
1. Error clear button	ON	Enable error reset command
	OFF	Disable error reset command
2. Safety-door Switch	Open	Make Servomotor decelerate to a stop and activate SOS function using SLS and SS2 functions. When SLS velocity limit or SOS position or velocity zero window is exceeded, Servo Drive goes into STO state and Excessive Limit Value Error occurs.
	Close	Deactivate SS2, SOS, and SLS functions with Servomotor set to run at normal velocity.

Input device	State	Operation
3. Safety Key Selector Switch	Normal operating mode	Safety-door Switch Open: Activate SS2 and SLS functions Safety-door Switch Closed: Deactivate SS2 and SLS functions
	Safety inactive mode	Deactivate SS2 function.
4. Emergency Stop Pushbutton Switch	ON	Enable STO command
	OFF	Disable STO command
5. Safety reset button	ON	Enable reset STO status command
	OFF	Disable reset STO status command

□ Operation of SS2 and SLS Functions with Motion Control

1. When the Servo ON command is enabled, the Servo Drive turns ON the Servo.
2. When an operation command is enabled, the command velocity to the Servomotor is set to 600 r/min.
3. When the SS2 function is executed, the Servo Drive shifts to the SOS state after the wait time (SS2 time to SOS 1) and monitors the motor position and velocity.
When the SLS function is executed, the Servo Drive shifts to the SLS state after the wait time (SLS time to velocity monitoring 1) and monitors the motor velocity.
The standard controller lets the Servomotor decelerate to a stop.
4. The Servo Drive monitors the motor velocity by releasing only the SS2 or SOS function with the SLS state maintained.
The standard controller sets the command velocity to the Servomotor to 60 r/min.
5. When the SS2 function is executed, the Servo Drive shifts to the SOS state after the wait time (SS2 time to SOS 1) and monitors the motor position and velocity.
The standard controller lets the Servomotor decelerate to a stop.
6. When the SS2 or SLS function is released, the Servo Drive goes into the normal state and stops monitoring the motor position and velocity.
The standard controller sets the command velocity to the Servomotor to 600 r/min.

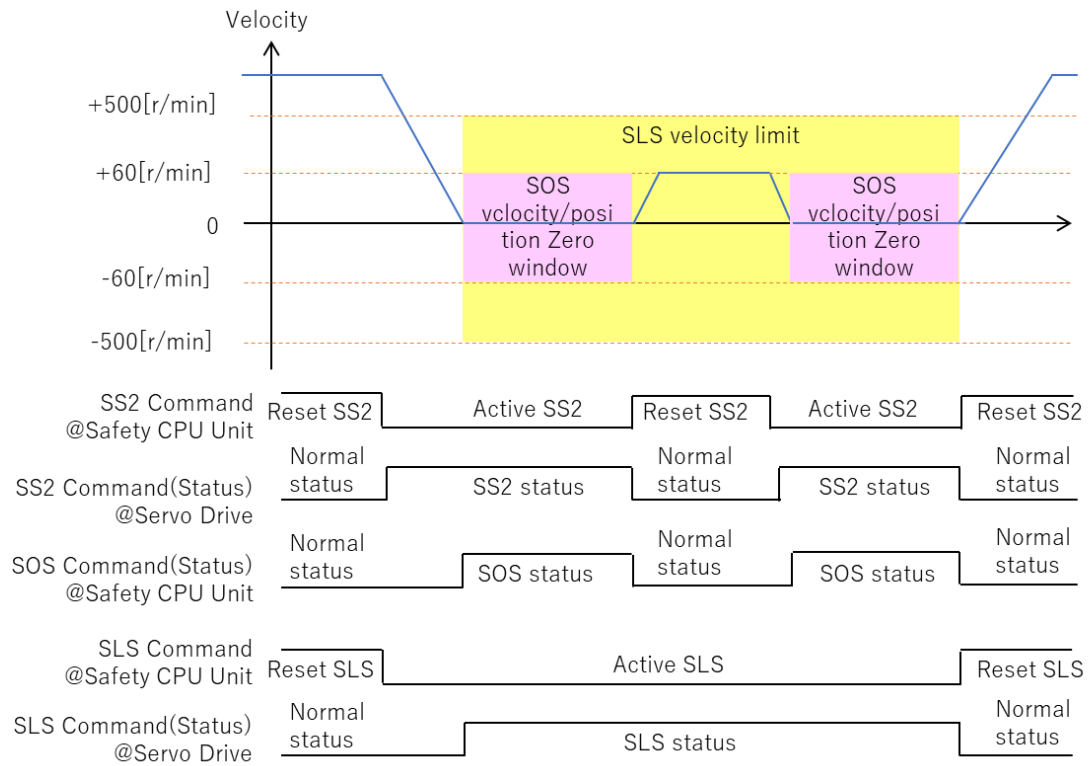

■ Setting the Safety Controller

1. Select *new_SafetyCPU0* from the list.

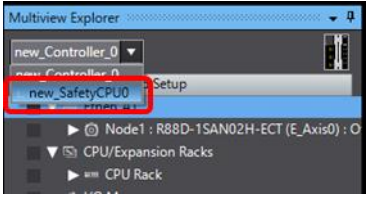
2. Click *SRA Parameters* and click the *Safety Function Assignment Settings* Button.

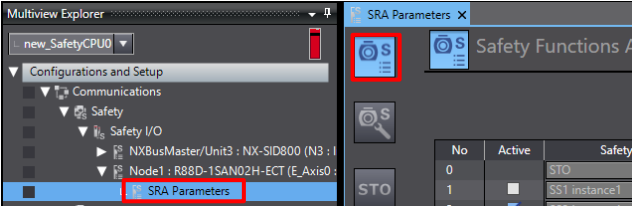

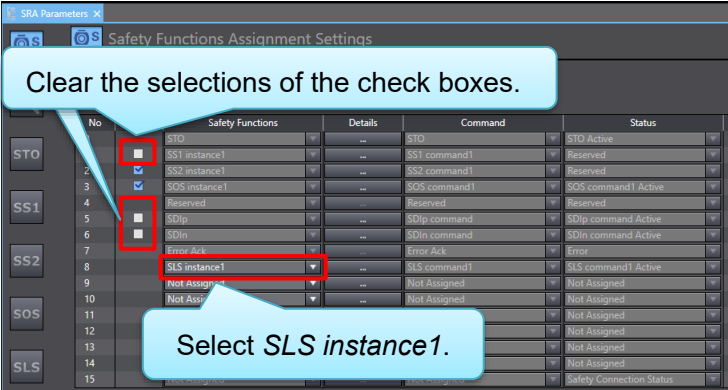
3. Assign *STO*, *SS2/SOS instance1*, and *SLS instance1*.



Clear the selections of the check boxes.

Select *SLS instance1*.

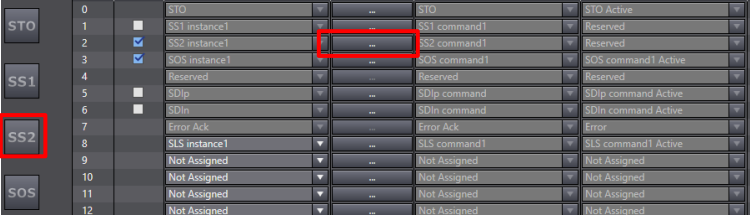
No	Safety Functions	Details	Command	Status
1	STO	...	STO	STO Active
2	<input type="checkbox"/> SS1 instance1	...	SS1 command1	Reserved
3	<input checked="" type="checkbox"/> SS2 instance1	...	SS2 command1	Reserved
4	<input checked="" type="checkbox"/> SOS instance1	...	SOS command1	SOS command1 Active
5	Reserved	...	Reserved	Reserved
6	<input type="checkbox"/> SDip	...	SDip command	SDip command Active
7	<input type="checkbox"/> SDIn	...	SDIn command	SDIn command Active
8	Error Ack	...	Error Ack	Error
9	<input checked="" type="checkbox"/> SLS instance1	...	SLS command1	SLS command1 Active
10	Not Assigned	...	Not Assigned	Not Assigned
11	Not Assigned	...	Not Assigned	Not Assigned
12	Not Assigned	...	Not Assigned	Not Assigned
13	Not Assigned	...	Not Assigned	Not Assigned
14	Not Assigned	...	Not Assigned	Not Assigned
15	Not Assigned	...	Not Assigned	Not Assigned
16	Safety Connection Status
4. Click the **SS2** Button to display the *SS2 Detailed Settings* view. You can also use the **...** Button to display the *SS2 Detailed Settings* view.



5. **Set SS2 parameters.**

In this guide, set them as follows.

Name	Value	Unit
SS2 time to SOS 1	1000	ms
SS2 time for velocity zero 1	500	ms

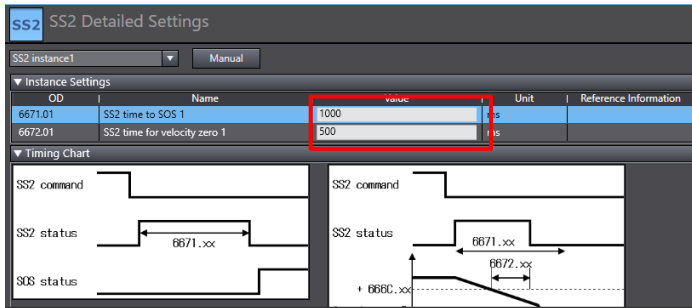

6. **Click the  Button and then click the SOS Detailed Settings view.**

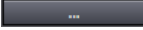
You can also use the  Button to display the SOS Detailed Settings view.

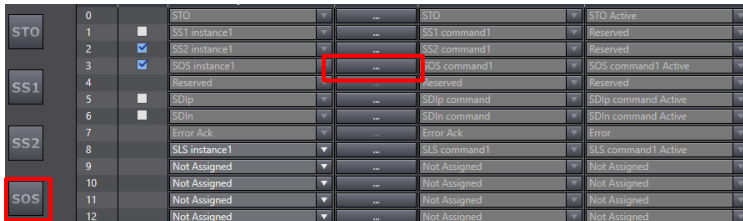

7. **Set SOS parameters.**

In this guide, set them as follows.

Name	Value	Unit
SOS position zero window 1	131072	EncoderUnit
SOS velocity zero window 1	60	r/min

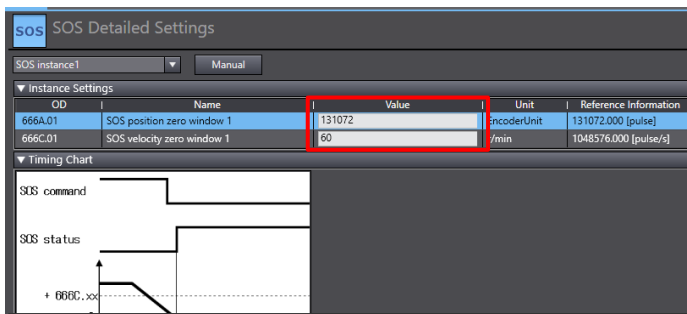

8. **Click the  Button to display the SLS Detailed Settings view.**

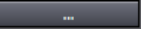
You can also use the  Button to display the SLS Detailed Settings view.

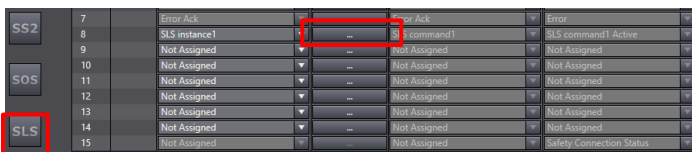

9. **Set SLS parameters.**

In this guide, set them as follows.

Name	Value	Unit
SLS time to velocity monitoring 1	1000	ms
SLS velocity limit 1	500	r/min
SLS time for velocity in limits 1	500	ms
Error Detection Activate In SLS Deactivate	Activate	-

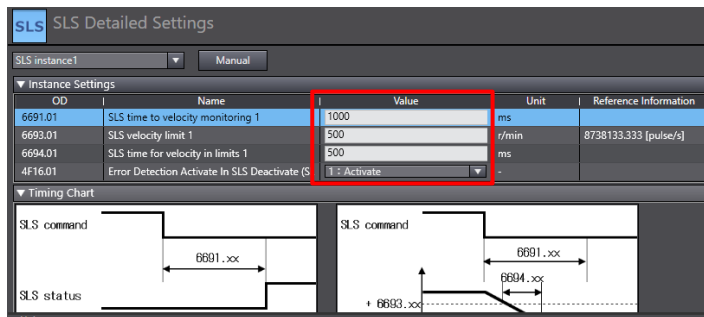

10. **Open the I/O Map and create device variables.**

Port	Variable name
SOS command1 Active for R88D-1SAN02H-ECT	E_Axis0_SOS_command1_Active
SLS command1 Active for R88D-1SAN02H-ECT	E_Axis0_SLS_command1_Active
SS2 command1 for R88D-1SAN02H-ECT	E_Axis0_SS2_command1
SOS command1 for R88D-1SAN02H-ECT	E_Axis0_SOS_command1
SLS command1 for R88D-1SAN02H-ECT	E_Axis0_SLS_command1

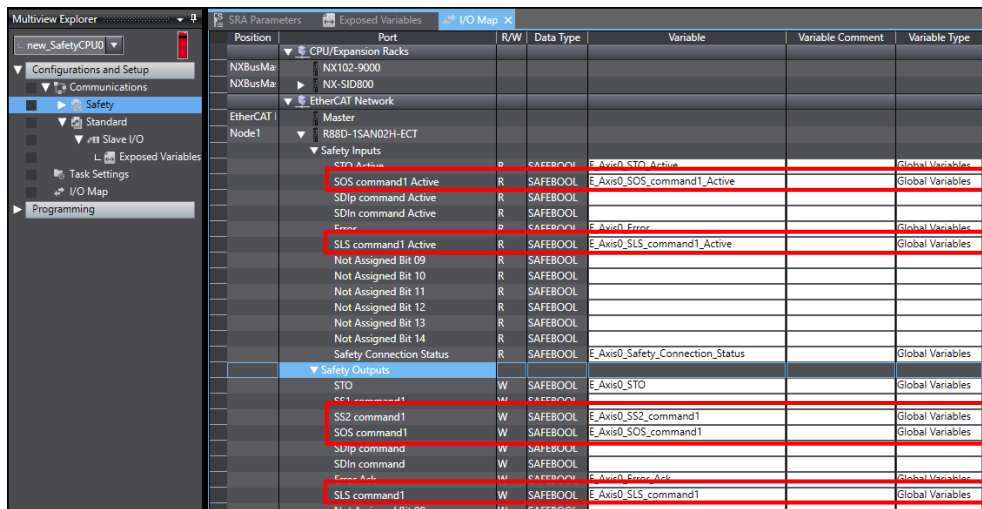

11. Create a safety program.
Add the following code to AutoProgram1.

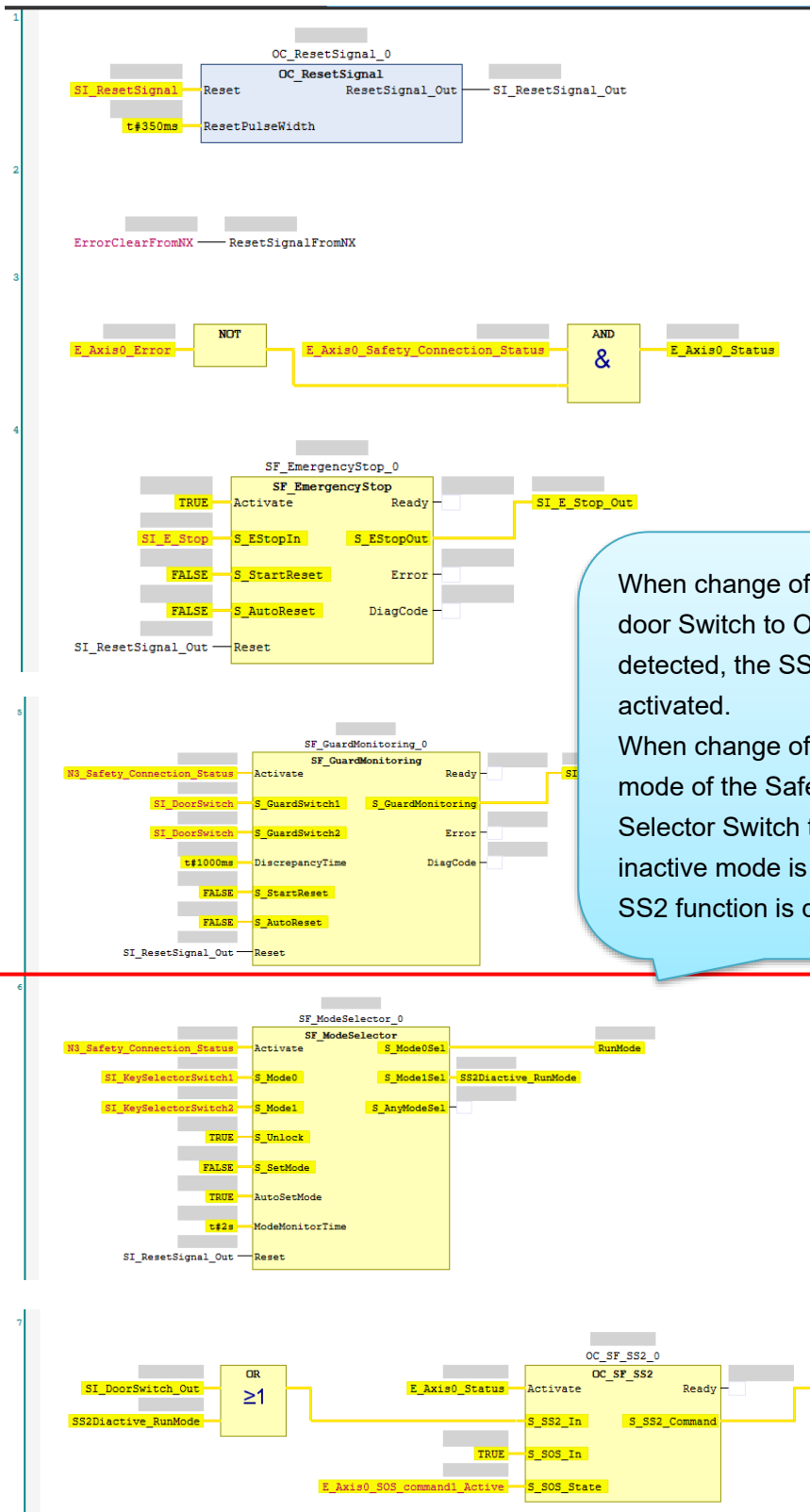

When change of the Safety-door Switch to Open is detected, the SS2 function is activated.

When change of the operating mode of the Safety Key Selector Switch to safety inactive mode is detected, the SS2 function is deactivated.

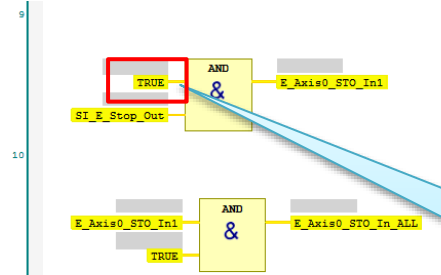
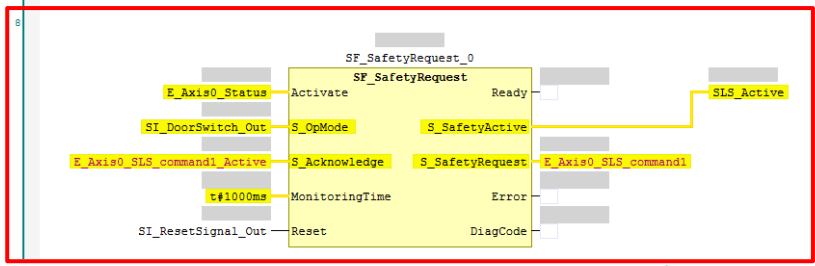

When change of the Safety-door Switch to Open is detected, the SS2 function is activated.

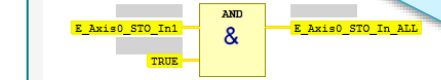

Change SI_DoorSwitch_Out to TRUE since the Safety-door Switch does not issue the STO command.

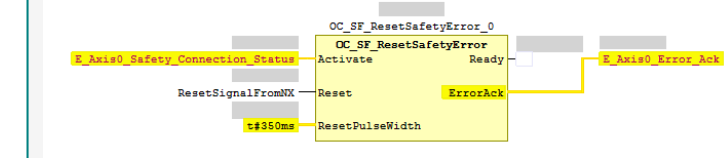
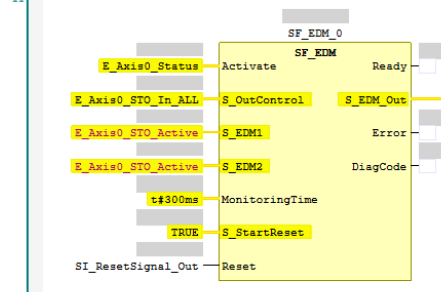

■ Setting the Standard Controller

1. Select `new_Controller_0` from the list.

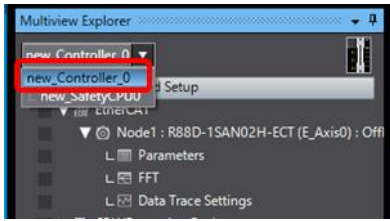

2. Double-click *I/O Map*.

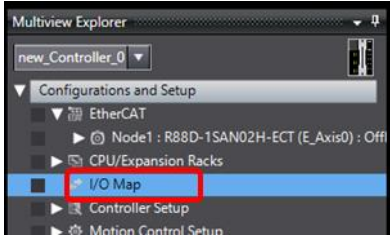

3. Create device variables.

Port	Variable name
SS2 command1 for R88D-1SAN02H-ECT	E_Axis0_SS2_command_1
SLS command1 for R88D-1SAN02H-ECT	E_Axis0_SLS_command_1
SOS command1 active for R88D-1SAN02H-ECT	E_Axis0_SOS_command_1_active
SLS command1 Active for R88D-1SAN02H-ECT	E_Axis0_SLS_command_1_Active

▼ Mirror Safety controlword	Mirror Safety controlword	R	UINT		
STO command	Mirror Safety Controlword	R	BOOL		
SS1 command 1	Mirror Safety Controlword	R	BOOL		
SS2 command 1	Mirror Safety Controlword	R	BOOL	E_Axis0_SS2_command_1	Global Variables
SOS command 1	Mirror Safety Controlword	R	BOOL		
Mirror Safety Controlword 4	Mirror Safety Controlword	R	BOOL		
SDI positive direction command	Mirror Safety Controlword	R	BOOL		
SDI negative direction command	Mirror Safety Controlword	R	BOOL		
error acknowledge	Mirror Safety Controlword	R	BOOL		
SLS command 1	Mirror Safety Controlword	R	BOOL	E_Axis0_SLS_command_1	Global Variables
Mirror Safety Controlword 9	Mirror Safety Controlword	R	BOOL		

▼ Mirror Safety statusword	Mirror Safety statusword	R	UINT		
STO command active	Mirror Safety Statusword 0	R	BOOL	E_Axis0_STO_command_active	Global Variables
Mirror Safety Statusword 1	Mirror Safety Statusword 1	R	BOOL		
Mirror Safety Statusword 2	Mirror Safety Statusword 2	R	BOOL		
SOS command 1 active	Mirror Safety Statusword 3	R	BOOL	E_Axis0_SOS_command_1_active	Global Variables
Mirror Safety Statusword 4	Mirror Safety Statusword 4	R	BOOL		
SDI positive direction command ac	Mirror Safety Statusword 5	R	BOOL		
SDI negative direction command ac	Mirror Safety Statusword 6	R	BOOL		
error acknowledge active	Mirror Safety Statusword 7	R	BOOL		
SLS command 1 active	Mirror Safety Statusword 8	R	BOOL	E_Axis0_SLS_command_1_active	Global Variables
Mirror Safety Statusword 9	Mirror Safety Statusword 9	R	BOOL		

4. **Create code for the standard program.**

Add the code to change the command velocity.

- When the SS2 or SOS function is active, reduce the command velocity to 0 r/min.
- When the SLS function is active, reduce the command velocity to 60 r/min.
- When the SS2, SOS, and SLS functions are all inactive, increase the command velocity to 600 r/min.

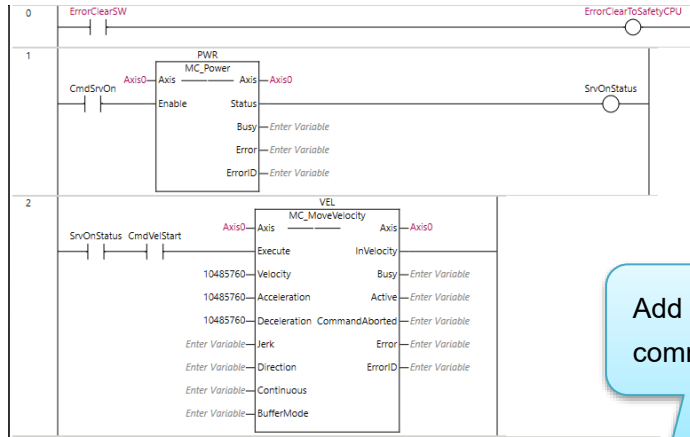

Add the code to change the command velocity here.

```

1 IF E_Axis0_SS2_command_1=FALSE OR E_Axis0_SOS_command_1_active = TRUE THEN
2   Axis0_SS2_VelFactor :=0;
3 ELSE
4   Axis0_SS2_VelFactor:=100;
5 END_IF;
6
7 IF E_Axis0_SLS_command_1=FALSE OR E_Axis0_SLS_command_1_active = TRUE THEN
8   Axis0_SLS_VelFactor :=10;
9 ELSE
10  Axis0_SLS_VelFactor:=100;
11 END_IF;
12
13 Axis0_VelFactor:=MIN(Axis0_SS2_VelFactor, Axis0_SLS_VelFactor);

```

Use the velocity in 1 or 2, whichever is smaller.

1. When SS2 or SOS function is active: 0 [r/min] (0% of command velocity)
When SS2 or SOS function is inactive: 600 [r/min] (100% of command velocity)
2. When SLS function is active: 60 [r/min] (10% of command velocity)
When SLS function is inactive: 600 [r/min] (100% of command velocity)

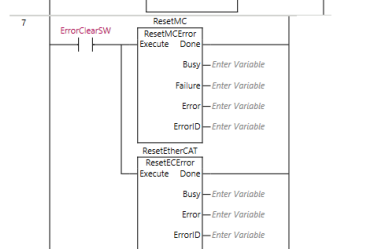
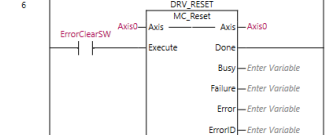
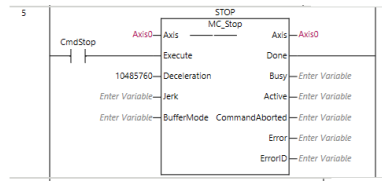
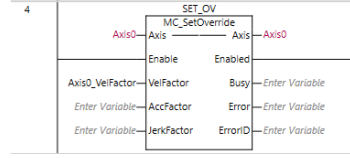

```

1 if E_Axis0_STO_command_active = TRUE THEN
2   CmdSrvOn:=FALSE;
3   CmdVelStart:=FALSE;
4 END_IF;

```

5. **Transfer to the standard controller.**

Select *new_Controller_0* from the list.

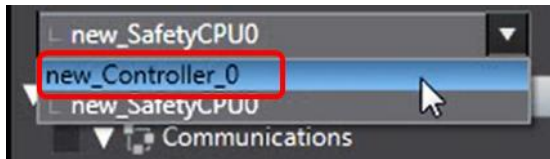

Connect to the standard controller.



Click the **Synchronization** Button to synchronize with the standard controller.



Transfer to the standard controller.

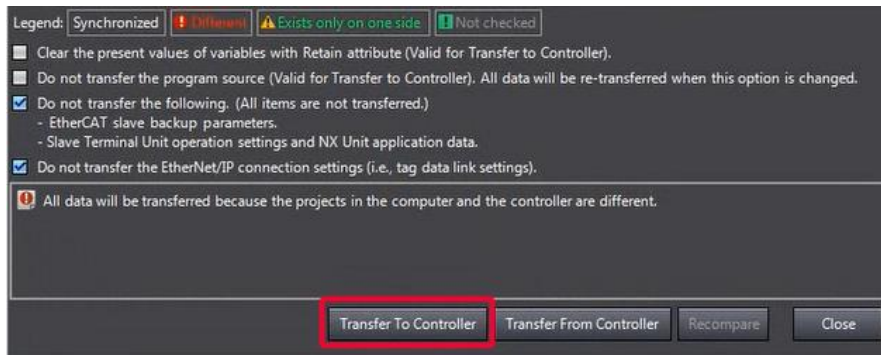

6. **Download the safety application.**

Select *new_SafetyCPU0* from the list.

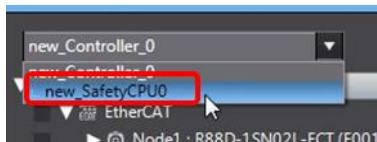

Click the **PROGRAM Mode** Button to switch to PROGRAM mode.



Click the **DEBUG Mode** Button to enter DEBUG mode.

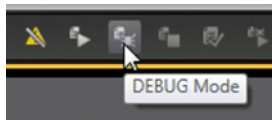

Click the **Start Debugging** Button to start DEBUG mode.

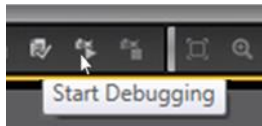

Click the **Safety Validation** Button.

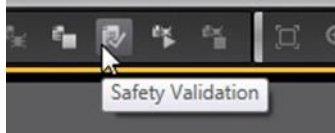

Click the **OK** Button.

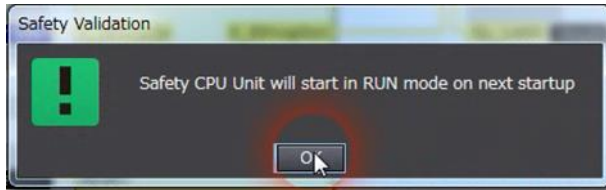

Click the **Run** Button.

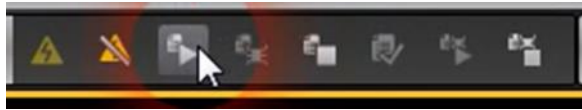









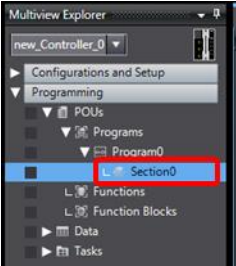
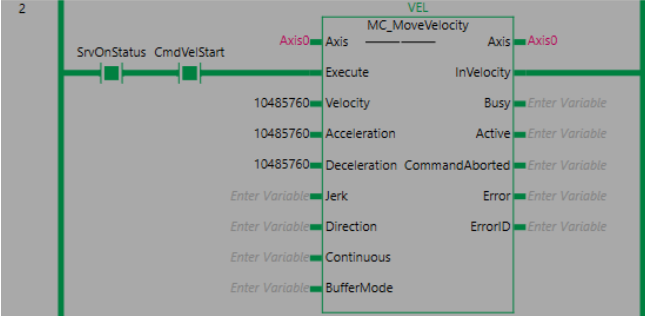

7. **The FSoE communications are now established.**

The FS indicator is lit in green.

FS	Displays FSoE communications status.	Green	ON	FSoE slave connection established
			Flashing	FSoE slave connection establishment in progress
		Red	Flashing	Safety Parameter Error, Safety Communications Timeout, or other errors
		--	OFF	The safety functions are disabled by FSoE, the power is not supplied, or a fatal error including Self-diagnosis Error

■ **Checking Operation of the SS2 and SLS Functions**

<p>1.</p>	<p>Check that the Safety Key Selector Switch is in normal operating mode.</p>  <p>The image shows a red safety key selector switch. To its right, the text 'SS2DEACTIVE' is displayed, and a red box highlights the word 'RUN'.</p>
<p>2.</p>	<p>Press the safety reset button.</p>  <p>The image shows a blue safety reset button with a white center.</p>
<p>3.</p>	<p>Double-click <i>Section0</i> to open the section.</p>  <p>The image shows a screenshot of a software interface's 'Multiview Explorer' pane. The tree view includes 'Configurations and Setup', 'Programming', 'POUs', 'Programs', 'Program0', and 'Section0'. 'Section0' is highlighted with a red box.</p>
<p>4.</p>	<p>Right-click <i>CmdVelStart</i> and select <i>Set/Reset – Set</i>.</p>  <p>The image shows a ladder logic diagram for the 'MC_MoveVelocity' function block. The 'CmdVelStart' input is connected to the 'Execute' input of the function block. The 'Axis' parameter is set to 'Axis0'. The 'InVelocity' input is connected to a variable 'Enter Variable'. The 'Velocity' parameter is set to '10485760' and 'Enter Variable'. The 'Acceleration' parameter is set to '10485760' and 'Enter Variable'. The 'Deceleration' parameter is set to '10485760' and 'Enter Variable'. The 'CommandAborted' parameter is set to 'Enter Variable'. The 'Jerk' parameter is set to 'Enter Variable'. The 'Direction' parameter is set to 'Enter Variable'. The 'Continuous' parameter is set to 'Enter Variable'. The 'BufferMode' parameter is set to 'Enter Variable'. The 'Error' parameter is set to 'Enter Variable'. The 'ErrorID' parameter is set to 'Enter Variable'.</p> <p>Check that the Servomotor rotates at about 600 r/min.</p>
<p>5.</p>	<p>Open the guard with the Safety-door Switch.</p>  <p>The image shows a safety-door switch mechanism with a red button and a metal housing.</p> <p>Check that the Servomotor decelerates to a stop. Check that the 7-segment LED display shows 'SF'.</p>  <p>The image shows a 7-segment LED display showing the characters 'SF'.</p>

<p>6.</p>	<p>Operate the Safety Key Selector Switch to switch to safety inactive mode.</p>  <p>Check that the Servomotor rotates at about 60 r/min. Check that the 7-segment LED display still shows 'SF'.</p> 
<p>7.</p>	<p>Operate the Safety key Selector Switch to switch to normal operating mode.</p>  <p>Check that the Servomotor decelerates to a stop. Check that the 7-segment LED display still shows 'SF'.</p> 
<p>8.</p>	<p>Close the guard and press the safety reset switch.</p> <p>Check that the Servomotor rotates at about 600 r/min. Check that the 7-segment LED display shows 'oE'.</p> 

Appendices

Adding a Servo Drive and Axis from Motor Sizing Tool Results

1. Import the motor sizing tool results file.

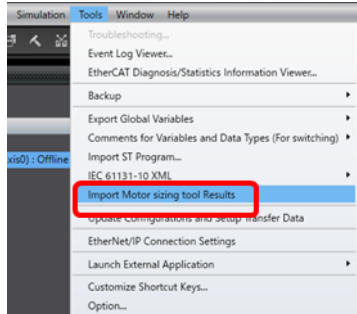

Note: Refer to the *Motor Sizing Tool Startup Guide* (Cat. No. I820) for learning how to create sizing results.

2. Devices were imported successfully.

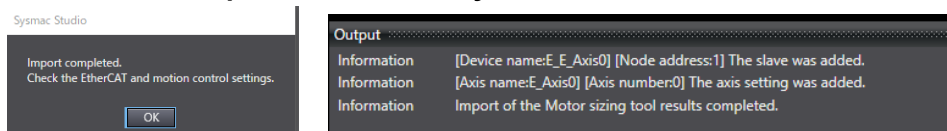

3. Check that the EtherCAT configuration has been updated.

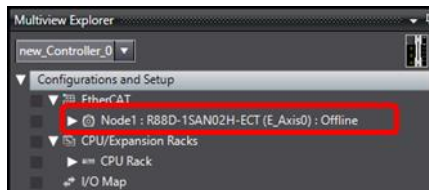

4. Servo Drive parameters have been updated.

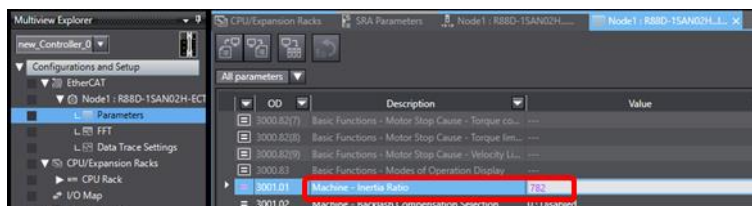

5. Axis settings have been created and updated.

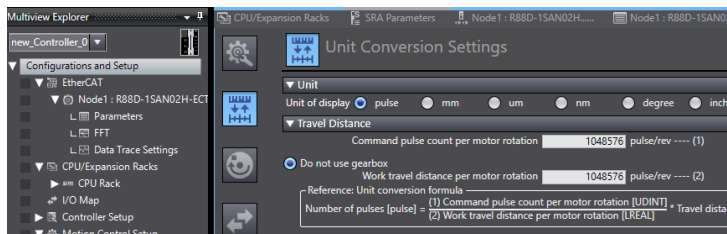

Test Run and Data Trace

1. Right-click the Servo Drive and select *Test Run* from the menu.

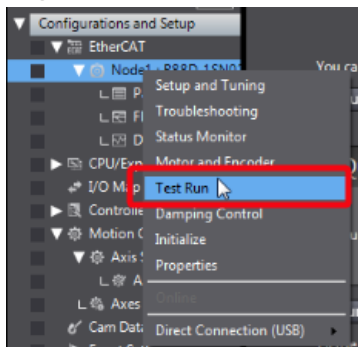

2. Click the *Step* Tab.
Adjust the motion profile.
Click the **Apply** Button.

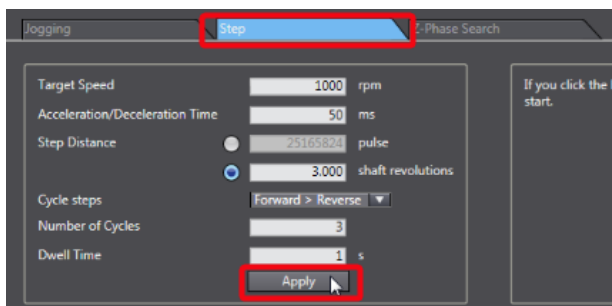

3. Click the **Servo ON** Button to turn ON the Servo.

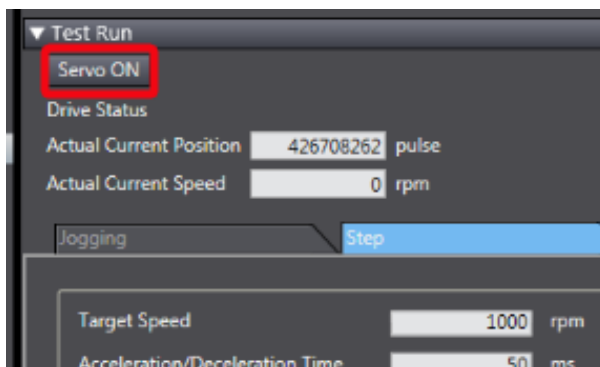

4. Right-click *Data Trace Settings* and select *Add - Data Trace* from the menu to add a new data trace.

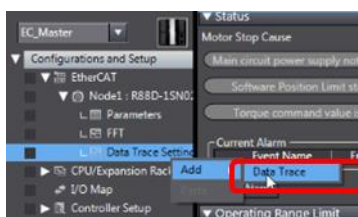

5 **Select *Cyclic* for the trace type.**

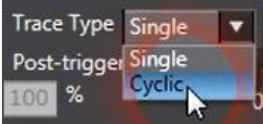

6 **Specify the sampling interval.**



7 **Specify the enable trigger condition.**

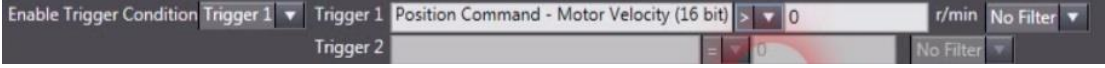

8 **Click the *Execute* Button.**



9 **Align the Test Run Window and the Data Trace Window horizontally by docking them.**

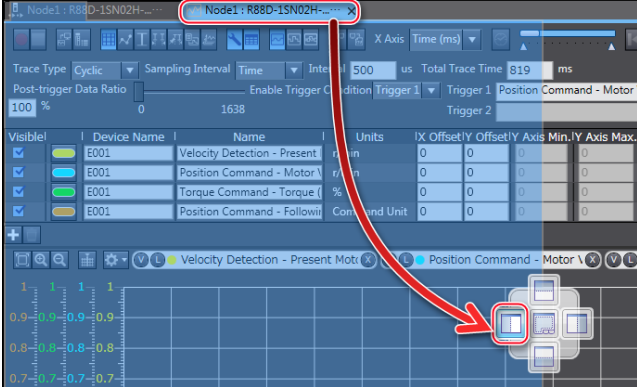

Click the **Start** Button in the Test Run Window to run the Servomotor.
Traced data will appear cyclically.

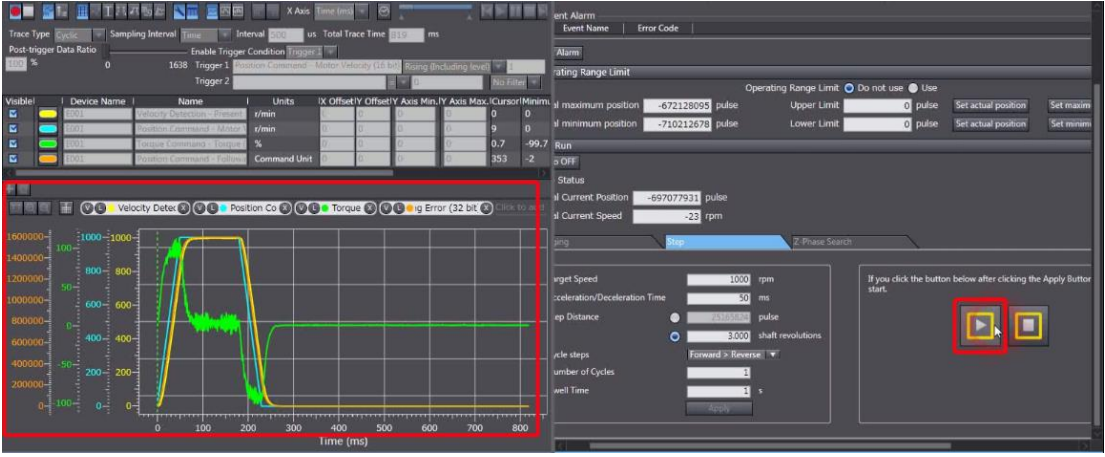

Manual Tuning

How to Perform Manual Tuning

This section describes how to change machine rigidity parameters for gain adjustment.

1. Right-click the Servo Drive and select *Setup and Tuning* from the menu.

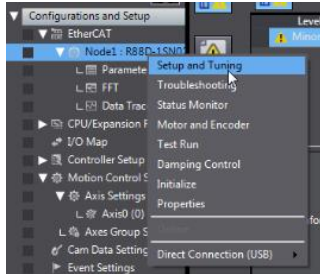

2. Click the *Manual Tuning* Button.

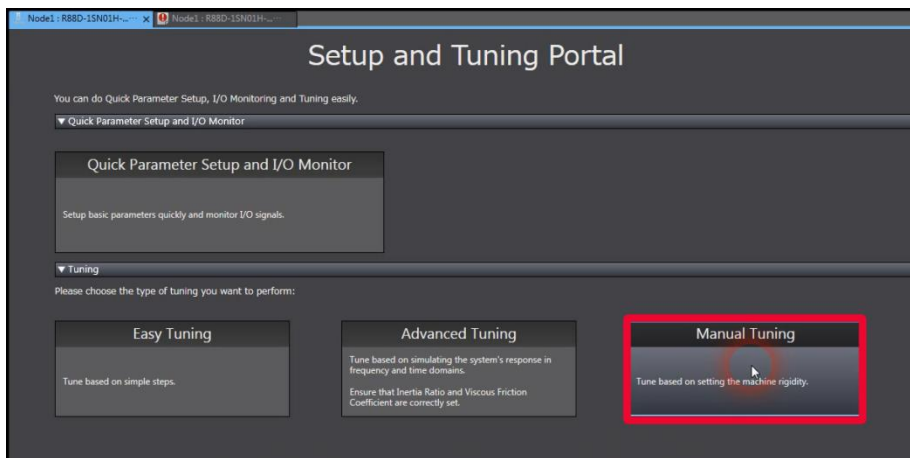

The *Manual Tuning* Window is displayed.

It includes machine rigidity settings, gain parameters, and Servo Drive test run.

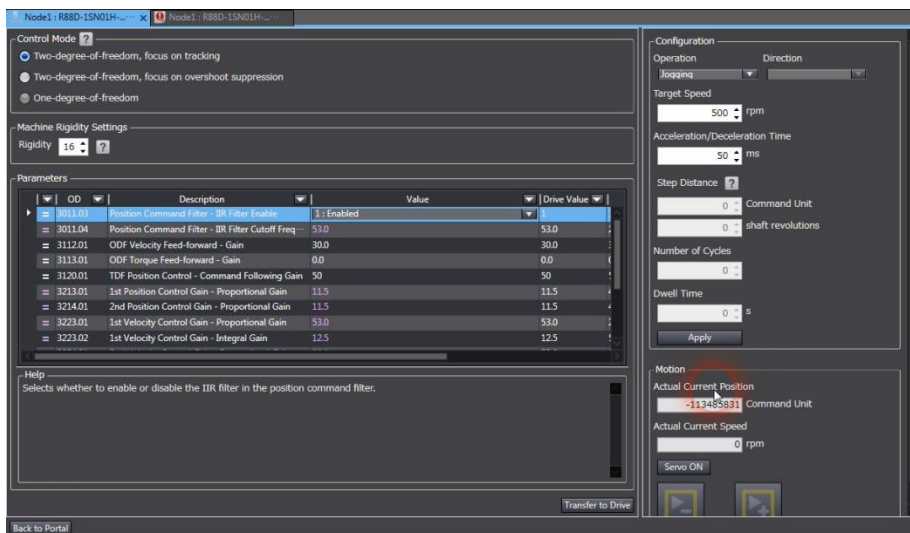

3. In order to check the behavior of the Servomotor, right-click *Data Trace Settings* and select *Add - Data Trace* from the menu to add a new data trace.



4. Select *Cyclic* for the trace type.



5. Adjust the sampling interval.



6. Adjust the enable trigger condition.



7. Click the *Transfer Parameters from Drive after Trace Button* to disable uploading parameters.



Click the *Execute* Button.



Sysmac Studio is now waiting for the trigger.



8. Align the Test Run Window and the Data Trace Window horizontally by docking them.



9. Configure the motion profile and click the **Apply** Button.

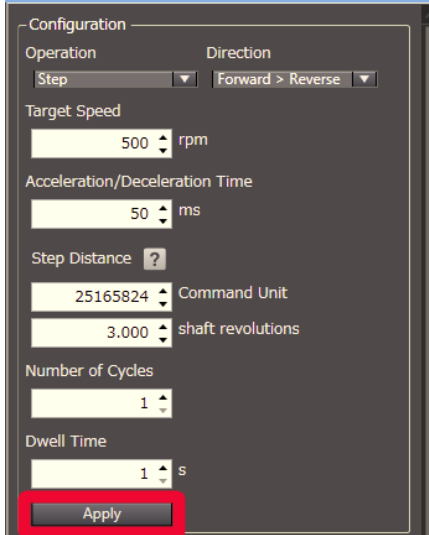

10. Click the **Servo ON** Button to turn ON the Servo and then click the **Start** Button.



Be careful because the Servomotor will move in forward and reverse directions.

11. Data trace is now triggered, and trace results are displayed.



Each time the Servomotor moves, traced data will appear cyclically.

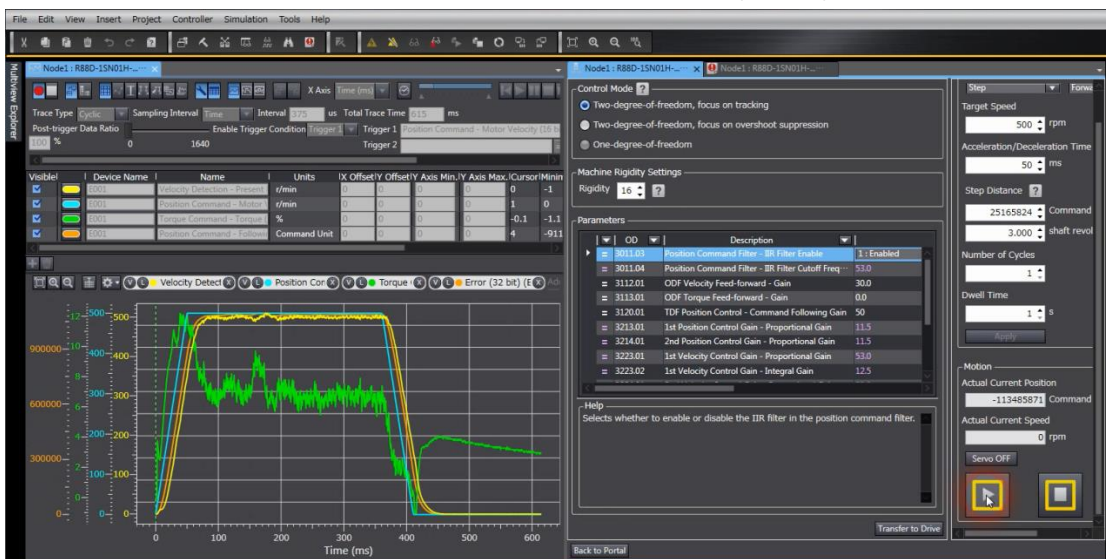

12. **It is possible to change gain values at once by changing the machine rigidity settings.**

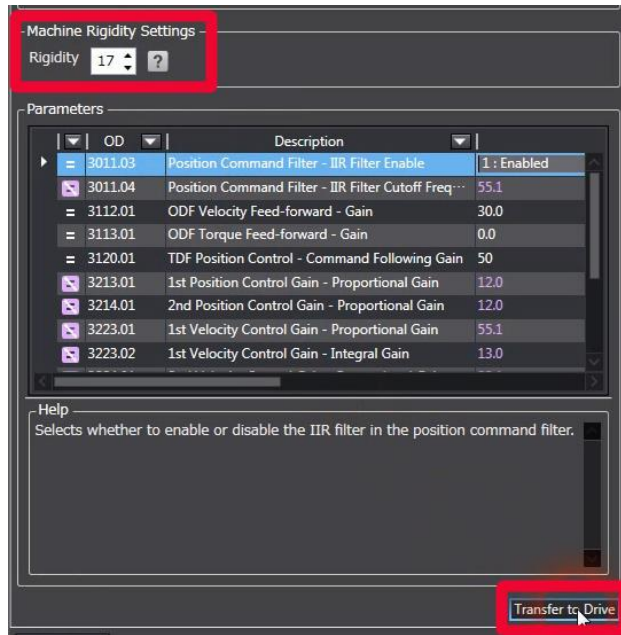

Click the **Transfer to Drive** Button to transfer the gain parameters to the Servo Drive.

13. **Repeat step 10, 11, and 12 until the desired performance is achieved.**
If vibrations occur, reduce the rigidity settings.
If required, it is possible to increase responsiveness by applying notch filters in advanced tuning and adjusting gains. Refer to the *Advanced Tuning* under *Appendices*.

Advanced Tuning

How to Perform Advanced Tuning

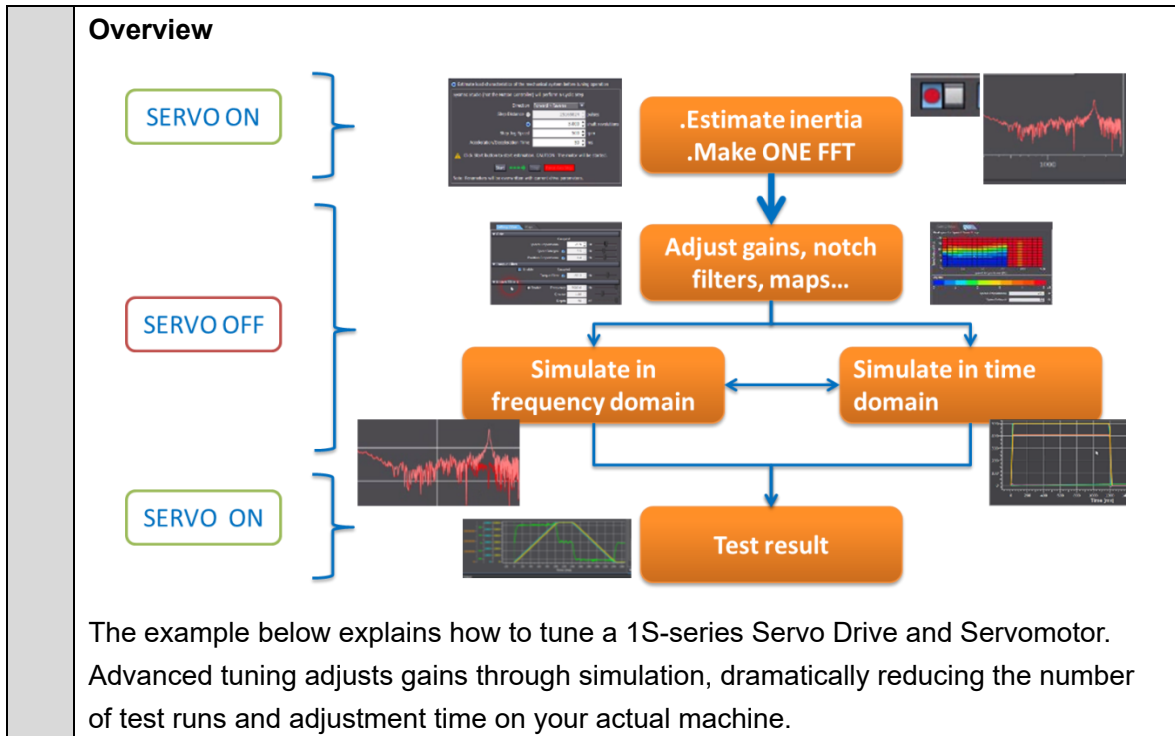

1. **Right-click the Servo Drive and select *Setup and Tuning* from the menu.**

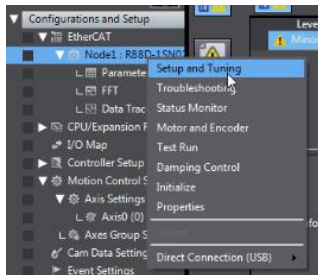

2. **Click the *Advanced Tuning* Button.**

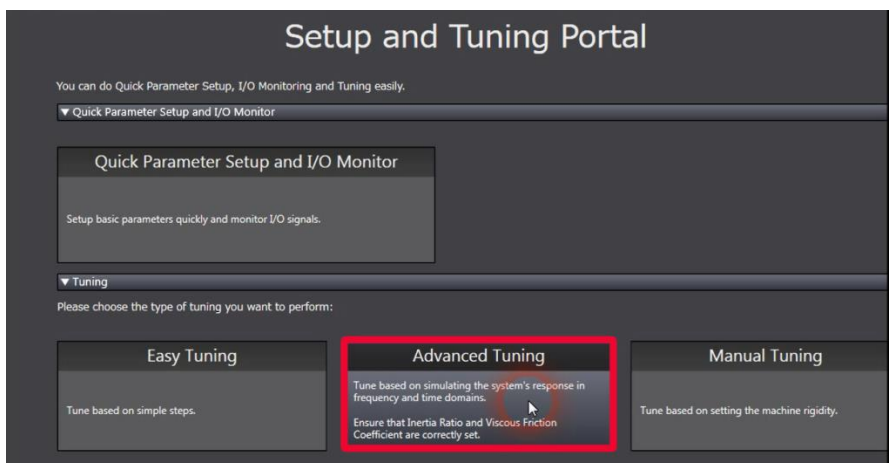

3. Configuration (Wizard Step 1)

Select the control mode.

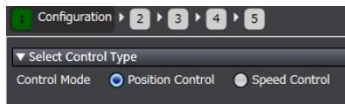

Click the **Start** Button to estimate load characteristics. (The motor will move.)

When easy tuning has been performed already to determine load characteristics, select **Use present setting** for the load characteristic settings.

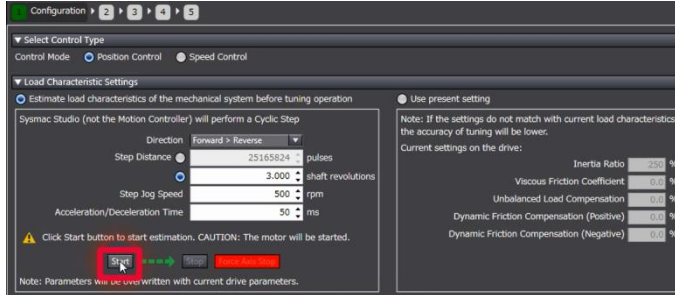

Load characteristics have been updated.

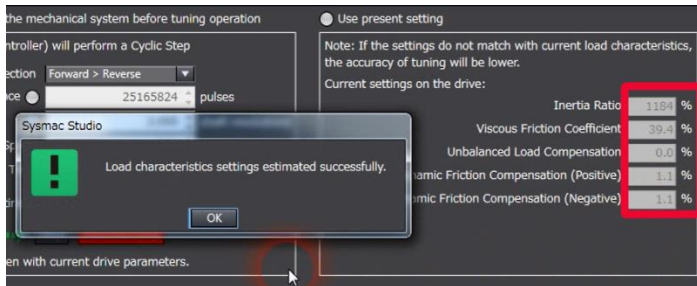

Click the **Next** Button.

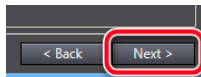

4. Frequency Response Simulation (Wizard Step 2)

Start tracing. (The Servomotor moves, and frequency characteristics are measured.)

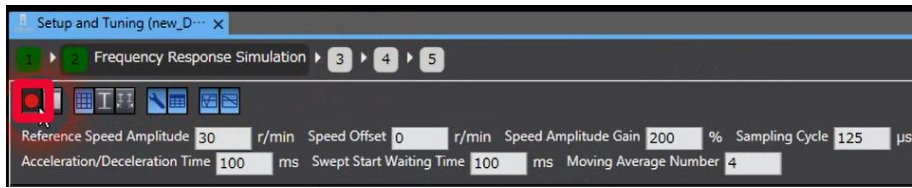

Gain and phase characteristics that were measured by FFT and simulated are displayed.

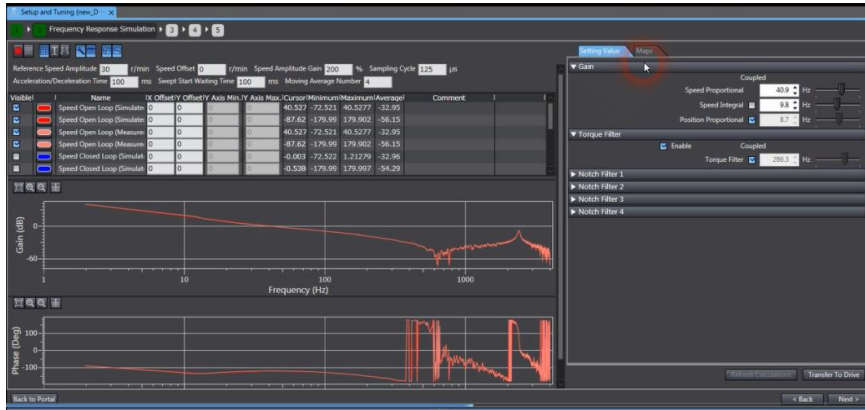

5. **Gain Adjustment and Simulation**

Select the **Maps** Tab.

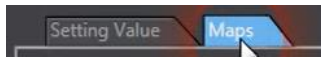

Responsiveness may fluctuate when the combination of gains in the red area is set. Click the area in other colors than red where the combination of gains is as large as possible and then click the **Refresh Calculations** Button.

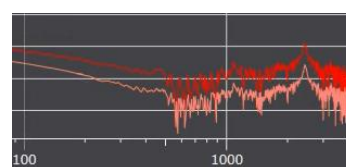
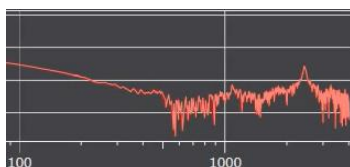
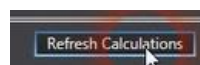
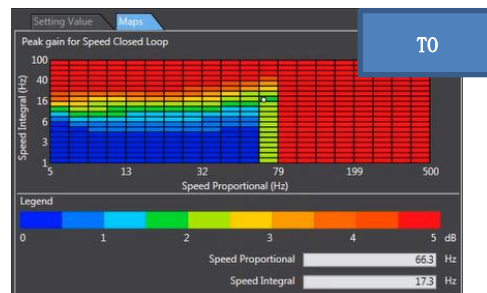
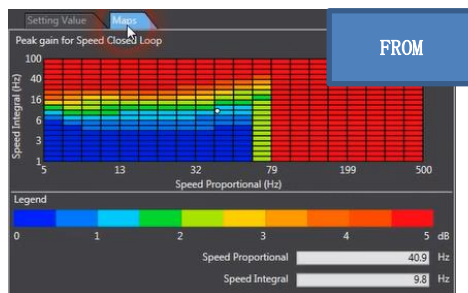
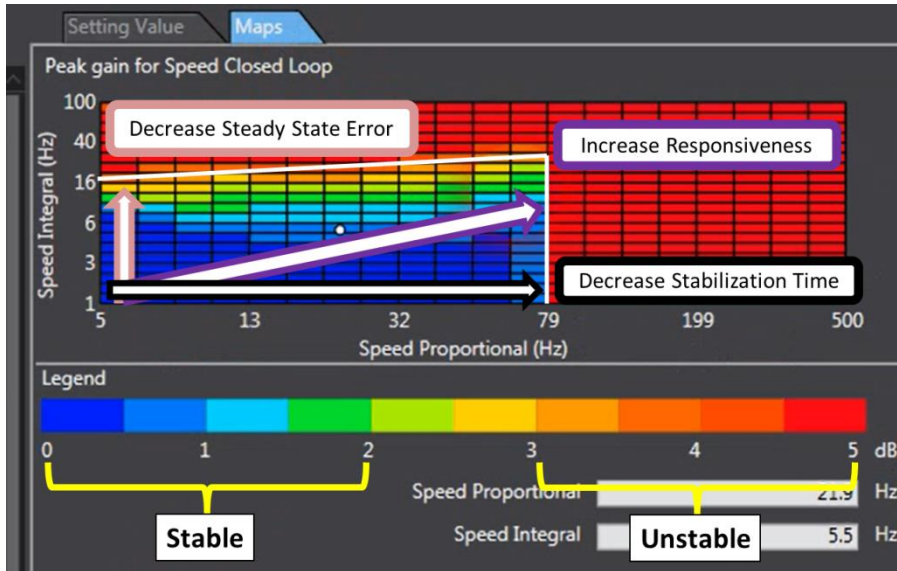

The pink waveform shows the frequency characteristic measured by FFT. The red waveform shows the simulated frequency characteristic when the gains selected above are applied.

6. **Notch Filter Adjustment and Simulation**

The gain simulation shows a resonance peak near 0 dB after gain adjustment. In some cases, the notch filter can suppress this resonance peak, which allows you to set higher gains.

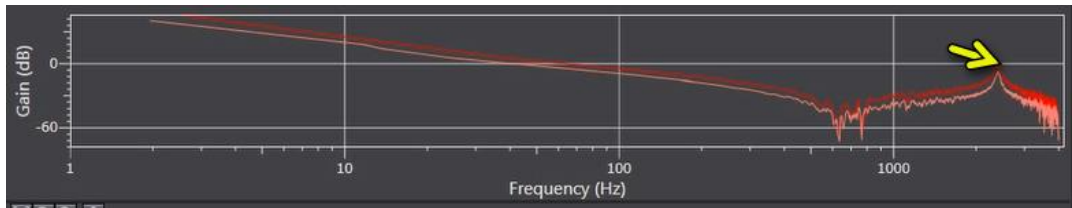

Activate the cursor to measure the frequency with a resonance peak.

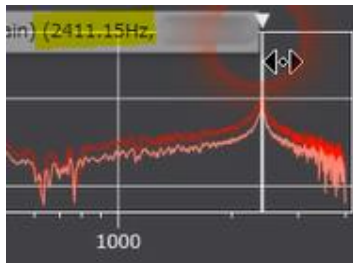

Enable the 1st notch filter to remove the resonance peak at 2400 Hz.

The control panel for 'Notch Filter 1' is shown. It includes a checkbox labeled 'Enable' which is checked and highlighted with a red box. Other parameters include 'Frequency' set to 2411 Hz, 'Q value' set to 1.40, and 'Depth' set to 60 dB. A 'Refresh Calculations' button is visible to the right. Below the control panel, a zoomed-in plot shows the resonance peak after the notch filter is applied, with the peak significantly reduced in height. The x-axis is labeled '1000'.

7. **Gain Increase in Map and Simulation**

You can see that the blue area in the map is expanded after the notch filter is enabled. Click the area in other colors than red where the combination of gains is as large as possible and then click the **Refresh Calculations** Button.

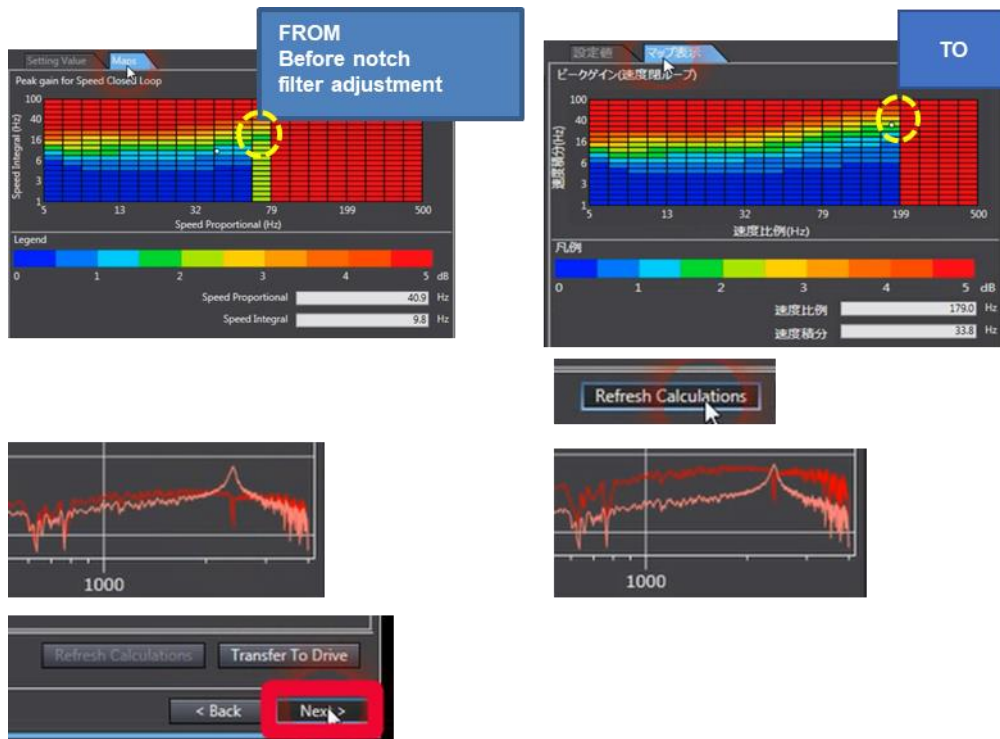

Click the **Next** Button.

8. **Time Response Simulation (Wizard Step 3)**

In time response simulation, response to the motion profile can be simulated.

Click the *Simulate Motion Profile* Button.

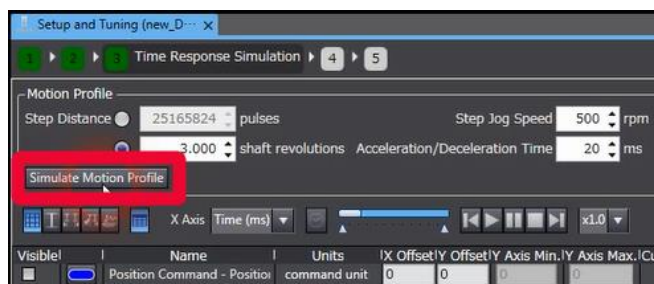

The chart is updated and shows:

- Velocity command, velocity detection simulation, and following error simulation

If necessary, adjust gains.

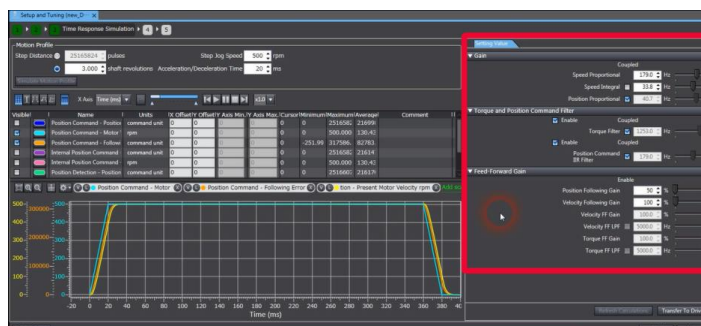

If your application requires a small following error, here is an example of position following gain adjustment.

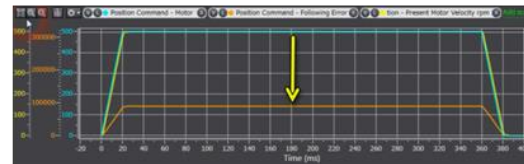
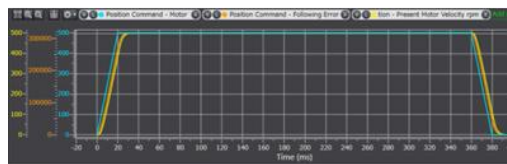

The following error has been reduced.

9. When satisfied with the simulation result, transfer parameters to the Servo Drive.

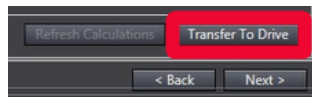

Click the *Next* Button.

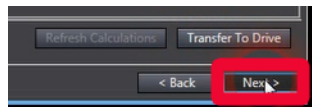

10 **Check Behavior (Wizard Step 4)**

Click the **Start Trace Button**. (The Servomotor will run based on the motion profile set in Wizard Step 3 (estimation of load characteristics).)

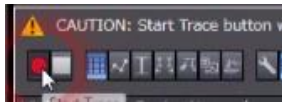

(Motion profile set in Wizard Step 3)

The traced data is displayed in charts.

- Velocity command, velocity detection, following error, and torque

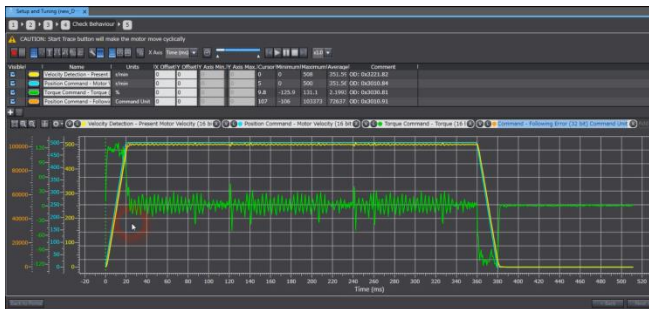

When satisfied with the result, click the **Next Button**.

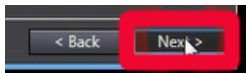

11. **Results (Wizard Step 5)**

Setup and Tuning (new_D) - Results

OD	Description	Value	Drive Value	Default	Range	Units	Data Attribute
3000.03	Basic Functions - Control Method Selection	1: TDF control	1	1	0 to 1	C	
3001.01	Machine - Inertia Ratio	1187	1187	250	0 to 10000	%	A
3011.03	Position Command Filter - BR Filter Enable	1: Enabled	1	1	0 to 1	A	
3011.04	Position Command Filter - BR Filter Cutoff Freq	179.0	179.0	21.9	1.0 to 5000.0	Hz	A
3112.01	ODF Velocity Feed-forward - Gain	30.0	30.0	30.0	0.0 to 100.0	%	A
3112.02	ODF Velocity Feed-forward - LPF Enable	0: Disabled	0	0	0 to 1	A	
3112.03	ODF Velocity Feed-forward - LPF Cutoff Freq	5000.0	5000.0	5000.0	1.0 to 50000.0	Hz	A
3113.01	ODF Torque Feed-forward - Gain	0.0	0.0	0.0	0.0 to 100.0	%	A
3113.02	ODF Torque Feed-forward - LPF Enable	0: Disabled	0	0	0 to 1	A	
3113.03	ODF Torque Feed-forward - LPF Cutoff Frequency	5000.0	5000.0	5000.0	1.0 to 50000.0	Hz	A
3120.01	TDF Position Control - Command Following Gain	600	600	50	10 to 5000	%	A
3121.01	TDF Velocity Control - Command Following Gain	100	100	100	10 to 5000	%	A
3213.01	1st Position Control Gain - Proportional Gain	40.7	40.7	4.4	0.0 to 500.0	Hz	A
3223.01	1st Velocity Control Gain - Proportional Gain	179.0	179.0	21.9	0.0 to 3000.0	Hz	A
3223.02	1st Velocity Control Gain - Integral Gain	33.8	33.8	5.5	0.0 to 16000.0	Hz	A
3233.01	1st Torque Command Filter - Enable	1: Enabled	1	1	0 to 1	A	
3233.02	1st Torque Command Filter - Cutoff Frequency	1253.0	1253.0	153.6	1.0 to 50000.0	Hz	A
3310.01	Torque Compensation - Viscous Friction Coeff	39.3	39.3	0.0	0.0 to 10000.0	%	A
3310.03	Torque Compensation - Positive Dynamic Frict	1.1	1.1	0.0	0.0 to 100.0	%	A
3310.04	Torque Compensation - Negative Dynamic Frict	1.1	1.1	0.0	0.0 to 100.0	%	A
3321.01	1st Notch Filter - Enable	1: Enabled	1	0	0 to 1	A	

Click the **Save to EEPROM Button** to save the results to the non-volatile memory.

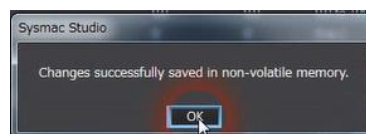
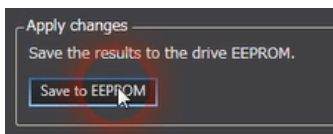

Click the **Finish Button**.



Note: Do not use this document to operate the Unit.

OMRON Corporation Industrial Automation Company

Tokyo, JAPAN

Contact: www.ia.omron.com

Regional Headquarters

OMRON EUROPE B.V.

Wegalaan 67-69, 2132 JD Hoofddorp
The Netherlands
Tel: (31)2356-81-300/Fax: (31)2356-81-388

OMRON ELECTRONICS LLC

2895 Greenspoint Parkway, Suite 200
Hoffman Estates, IL 60169 U.S.A
Tel: (1) 847-843-7900/Fax: (1) 847-843-7787

OMRON ASIA PACIFIC PTE. LTD.

No. 438A Alexandra Road # 05-05/08 (Lobby 2),
Alexandra Technopark,
Singapore 119967
Tel: (65) 6835-3011/Fax: (65) 6835-2711

OMRON (CHINA) CO., LTD.

Room 2211, Bank of China Tower,
200 Yin Cheng Zhong Road,
PuDong New Area, Shanghai, 200120, China
Tel: (86) 21-5037-2222/Fax: (86) 21-5037-2200

Authorized Distributor:

© OMRON Corporation 2021 All Rights Reserved.
In the interest of product improvement,
specifications are subject to change without notice.

Cat. No. I859-E1-03

0921 (1220)