

## Environment-resistant IP67 Power Supply

User's Manual  
S8NR-S (360W, 600W)

1

Features and  
Functions

2

Specifications  
and Functions

3

Installation  
and Wiring

4

Parameter  
Settings

5

IO-Link  
Communication

6

Trial Operation to  
Actual Operation

7

Error Processing

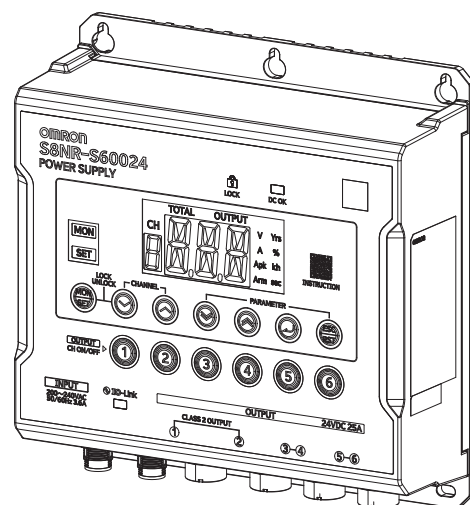

## **NOTE**

All rights reserved. No part of this publication may be reproduced, stored in a retrieval system, or transmitted, in any form, or by any means, mechanical, electronic, photocopying, recording, or otherwise, without the prior written permission of OMRON.

No patent liability is assumed with respect to the use of the information contained herein. Moreover, because OMRON is constantly striving to improve its high-quality products, the information contained in this manual is subject to change without notice. Every precaution has been taken in the preparation of this manual. Nevertheless, OMRON assumes no responsibility for errors or omissions. Neither is any liability assumed for damages resulting from the use of the information contained in this publication.

## **Trademarks**

- Microsoft, Windows is either registered trademarks or trademarks of Microsoft Corporation in the United States and other countries.

Other company names and product names in this document are the trademarks or registered trademarks of their respective companies.

## **Copyrights**

Microsoft product screen shots reprinted with permission from Microsoft Corporation.

# Preface

---

Thank you for purchasing the S8NR-S Environment-resistant IP67 Power Supply.

This User's Manual describes the functions, performance, and application methods required to use the S8NR-S.

Please read this manual carefully and be sure you understand the information provided before attempting to install or operate the S8NR-S Environment-resistant IP67 Power Supply.

Keep this User's Manual close at hand and use it for reference during operation.

Make sure that a specialist with knowledge of electrical systems operates the S8NR-S.

# Terms and Conditions Agreement

---

## Warranty, Limitations of Liability

### Warranties

---

- **Exclusive Warranty**

Omron's exclusive warranty is that the Products will be free from defects in materials and workmanship for a period of twelve months from the date of sale by Omron (or such other period expressed in writing by Omron). Omron disclaims all other warranties, express or implied.

- **Limitations**

OMRON MAKES NO WARRANTY OR REPRESENTATION, EXPRESS OR IMPLIED, ABOUT NON-INFRINGEMENT, MERCHANTABILITY OR FITNESS FOR A PARTICULAR PURPOSE OF THE PRODUCTS. BUYER ACKNOWLEDGES THAT IT ALONE HAS DETERMINED THAT THE PRODUCTS WILL SUITABLY MEET THE REQUIREMENTS OF THEIR INTENDED USE.

Omron further disclaims all warranties and responsibility of any type for claims or expenses based on infringement by the Products or otherwise of any intellectual property right.

- **Buyer Remedy**

Omron's sole obligation hereunder shall be, at Omron's election, to (i) replace (in the form originally shipped with Buyer responsible for labor charges for removal or replacement thereof) the non-complying Product, (ii) repair the non-complying Product, or (iii) repay or credit Buyer an amount equal to the purchase price of the non-complying Product; provided that in no event shall Omron be responsible for warranty, repair, indemnity or any other claims or expenses regarding the Products unless Omron's analysis confirms that the Products were properly handled, stored, installed and maintained and not subject to contamination, abuse, misuse or inappropriate modification. Return of any Products by Buyer must be approved in writing by Omron before shipment. Omron Companies shall not be liable for the suitability or unsuitability or the results from the use of Products in combination with any electrical or electronic components, circuits, system assemblies or any other materials or substances or environments. Any advice, recommendations or information given orally or in writing, are not to be construed as an amendment or addition to the above warranty.

See <http://www.omron.com/global/> or contact your Omron representative for published information.

### Limitation on Liability; Etc

---

OMRON COMPANIES SHALL NOT BE LIABLE FOR SPECIAL, INDIRECT, INCIDENTAL, OR CONSEQUENTIAL DAMAGES, LOSS OF PROFITS OR PRODUCTION OR COMMERCIAL LOSS IN ANY WAY CONNECTED WITH THE PRODUCTS, WHETHER SUCH CLAIM IS BASED IN CONTRACT, WARRANTY, NEGLIGENCE OR STRICT LIABILITY.

Further, in no event shall liability of Omron Companies exceed the individual price of the Product on which liability is asserted.

## Application Considerations

### Suitability of Use

---

Omron Companies shall not be responsible for conformity with any standards, codes or regulations which apply to the combination of the Product in the Buyer's application or use of the Product. At Buyer's request, Omron will provide applicable third party certification documents identifying ratings and limitations of use which apply to the Product. This information by itself is not sufficient for a complete determination of the suitability of the Product in combination with the end product, machine, system, or other application or use. Buyer shall be solely responsible for determining appropriateness of the particular Product with respect to Buyer's application, product or system. Buyer shall take application responsibility in all cases.

NEVER USE THE PRODUCT FOR AN APPLICATION INVOLVING SERIOUS RISK TO LIFE OR PROPERTY WITHOUT ENSURING THAT THE SYSTEM AS A WHOLE HAS BEEN DESIGNED TO ADDRESS THE RISKS, AND THAT THE OMRON PRODUCT(S) IS PROPERLY RATED AND INSTALLED FOR THE INTENDED USE WITHIN THE OVERALL EQUIPMENT OR SYSTEM.

### Programmable Products

---

Omron Companies shall not be responsible for the user's programming of a programmable Product, or any consequence thereof.

## Disclaimers

### Performance Data

---

Data presented in Omron Company websites, catalogs and other materials is provided as a guide for the user in determining suitability and does not constitute a warranty. It may represent the result of Omron's test conditions, and the user must correlate it to actual application requirements. Actual performance is subject to the Omron's Warranty and Limitations of Liability.

### Change in Specifications

---

Product specifications and accessories may be changed at any time based on improvements and other reasons. It is our practice to change part numbers when published ratings or features are changed, or when significant construction changes are made. However, some specifications of the Product may be changed without any notice. When in doubt, special part numbers may be assigned to fix or establish key specifications for your application. Please consult with your Omron's representative at any time to confirm actual specifications of purchased Product.

### Errors and Omissions

---

Information presented by Omron Companies has been checked and is believed to be accurate; however, no responsibility is assumed for clerical, typographical or proofreading errors or omissions.

# Safety Precautions





## Definition of Precautionary Information

The following notation is used in this manual to provide precautions required to ensure safe usage of the S8NR-S.

The safety precautions that are provided are extremely important to safety. Always read and heed the information provided in all safety precautions.

The following notation is used.

 <b>CAUTION</b>	Indicates a potentially hazardous situation which, if not avoided, will result in minor or moderate injury, or there may be property damage.
--	--

 <b>CAUTION</b>	
Minor electric shock, fire, or Product failure may occasionally occur. Do not disassemble, modify, or repair the Product or touch the interior of the Product.	
Minor burns may occasionally occur. Do not touch the Product while power is being supplied or immediately after power is turned OFF.	
To prevent unauthorized access, set a protection level on this product. The parameter read and setting operations use 3 levels of restriction.	

# Precautions for Safe Use

---

The smart power supply S8NR-S integrates the high-reliability switching power supply S8VK-S and a digital multi-circuit protector into a single unit to reduce wiring and save space.

The built-in digital circuit protector differs from general circuit protectors. It does not have a contact-type switching mechanism, and it connects and disconnects circuits by using power MOSFETs.

Before you install and use the S8NR-S, understand the following points.

## ● Installing/Storage Environment

- Store the Product at a temperature of -40 to +85°C and a humidity of 5 to 95% or less.
- To maintain the performance of the maintenance forecast monitor, store the Product at a temperature of -20 to +30°C and a relative humidity of 25 to 70% when storing it for more than three months.
- During installation, ensure adequate heat dissipation to improve the long-term reliability of the equipment. Because this Product uses natural air convection, install it so that the air around the Product can circulate freely.
- The internal parts may occasionally deteriorate or be damaged. Do not use the Product in areas outside the derating curves.
- Internal parts may possibly be damaged. Do not use a current that exceeds the rated total output current of the power supply. If temporary peak currents occur repetitively, design the system so that the peak values do not exceed the peak load conditions.
- Use the Product in locations with a relative humidity of 5 to 95% or less.
- Do not use the Product in low dew point environments.
- Do not use the Product outdoors or where it would be subjected to direct sunlight.
- Do not use the Product where it would be subjected to shock or vibration. A device such as a contact breaker may be a vibration source. Set the Product as far as possible from possible sources of shock or vibration.
- To prevent an accident due to the product falling, wear appropriate protective gear such as safety shoes, safety glasses, and a helmet when performing installation or replacement work.
- Due to degraded heat dissipation and loss of protective structure, internal parts may occasionally deteriorate or be damaged. Do not loosen the screws on the power supply unit.
- If the Product is used in an area with excessive electronic noise, be sure to separate the Product as far as possible from the noise sources.
- Do not use the Product in locations where oil mist is present.
- Do not use the Product in locations where it may be exposed to high-pressure water.
- Do not use the Product in locations where spatter may occur.
- Do not use the Product in locations where corrosive or volatile gases are generated.
- Avoid installing the Product in locations where the temperature changes rapidly, such as near exhaust outlets.
- Do not use the Product at altitudes above 3,000 m, as the protective structure may not be maintained.
- Do not use detergents or chemicals for cleaning.
- Do not connect a battery or other backup power supply to the output of the Product.
- Although some inverters have an output frequency of 50/60 Hz, they may cause internal temperature to rise and result in damage, if they are connected as the power source for the S8NR-S. Do not use the output from an inverter as the power source for the S8NR-S.
- When connecting a UPS to the input, do not use a UPS with a rectangular-wave output. A rise in internal temperature may cause smoke or malfunction.
- Do not use this Product as a foothold.
- Avoid contact with the Product when passing nearby.

● **Installation/Wiring**

- Connect the ground completely. A protective earthing terminal stipulated in safety standards is used. Electric shock or malfunction may occur if the ground is not connected completely.
- Minor fire may possibly occur. Ensure that input and output terminals are wired correctly.
- To prevent wiring materials from smoking or ignition, use the wiring materials given in the following table.

**Recommended Cables:**

Terminal (Product side)	Connector name (Product side)	Recommended cables	
		Both-end connector	One-end connector
Input Terminal	M12-S (Plug)	XS5W-S321-□22-F	XS5F-S321-□22-F
Output Terminal	M12-A (Socket)	XS5W-D421-□81-F XS5W-D521-□G1-F	XS5F-D421-□80-F XS5F-D521-□G0-F
	M12-L (Socket)	XS5W-L521-□12-F	XS5H-L521-□12-F
IO-Link Communication Terminal	M12-A (Plug)	XS5W-D421-□81-F XS5W-D521-□G1-F	XS5H-D421-□80-F XS5H-D521-□G0-F

Use copper wires. Use stranded wire or solid wire (heat resistance: 75°C or higher).

- Do not insert or remove the Smart Click connector more than the durability limit of 50 cycles.

● **Branch Output**

- Do not repeat cutoff and recovery operations more than necessary, because internal components may deteriorate or be damaged.
- Cutoff performance is guaranteed according to the ambient temperature. Do not use the Product outside the derating curves.

● **Output Voltage Adjustment**

360W, 600W

Default Setting: Set at the rated voltage Adjustment Range:

The output voltage can be adjusted from 24 to 28 VDC using the Select Down Key / Select Up Key on the front panel.

- Adjust the output voltage using “V-O” in the setting mode.
- When decreasing the output voltage, the undervoltage alarm function may operate depending on its setting value.
- After adjusting the output voltage, ensure that the total output power and output current of each branch output do not exceed the rated output power and rated total output current.

## ● Peak Current

Peak current is the current that can exceed the rated current for a limited period of time. The Product can be used within the range that satisfies the following five conditions:

- Peak-current duration:  $t_1 \leq 5 \text{ s}$
- Peak current:  $I_p \leq \text{Maximum Peak Current} = \text{Rated Total Output Current} \times 150\%$
- Average output current:  $I_{ave} \leq \text{Rated Total Output Current} \times 80\%$
- Peak-current duty ratio:  $\text{Duty} \leq 10\%$
- $\text{Duty} = T_1 / (t_1 + t_2) \times 100 [\%] \leq 10\%$  The Product can be used at the rated current after completion of the  $t_2$  period.
- Do not allow peak current to continue for more than 5 seconds. Also, do not exceed a 10% duty ratio. Doing so may cause Product damage.
- Do not allow the average current over one peak current cycle to exceed 80% of the rated total output current. Product damage may occur.
- Reduce the peak current and average output current depending on the ambient operating temperature and installation conditions.

# Precautions for Correct Use

- When the tripping alarm output operates, always remove the cause of the output first and then reset the alarm.
- When cycling the input power supply, always remove any problems first and then turn ON the input power supply.

## ● Mounting

- Mounting Direction  
Mount the S8NR-S in the standard mounting or the horizontal mounting. Do not mount it in any other orientation. (See page 3-3)

## ● Derating Curve

The temperature range within which the S8NR-S can be used is restricted by the maximum current that normally flows for the total output. This restriction is given as a derating curve.

Horizontal separation of 15 mm or more

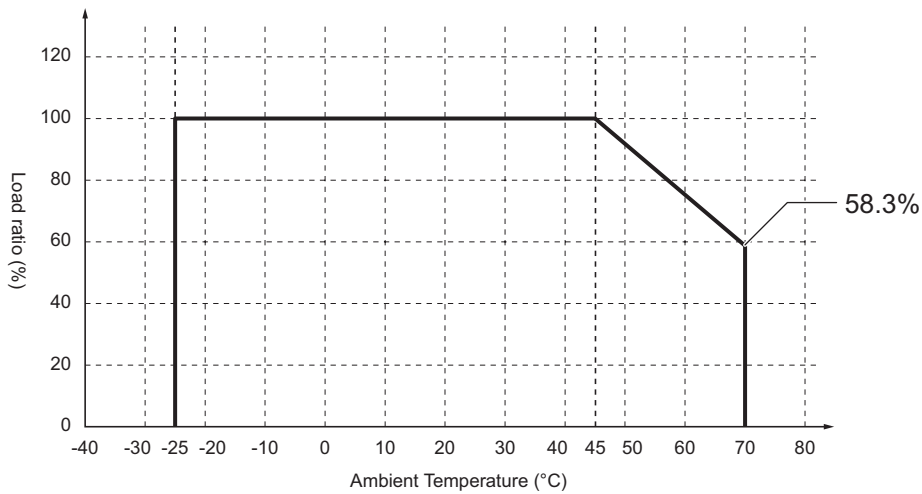

Note 1. Apply an additional load reduction coefficient based on the input voltage to the load factor indicated in the output derating chart above.

### Load Reduction Coefficient Based on Input Voltage

#### ●S8NR-S36024-A□L□-IL3

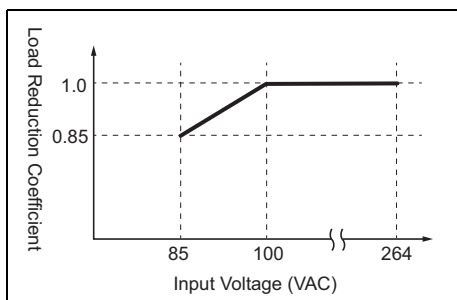

#### ●S8NR-S60024-A□L□-IL3

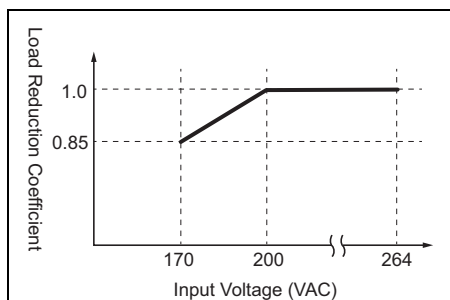

This product can be used at altitudes of up to 3,000 m.

When used at altitudes between 2,000 m and 3,000 m, please operate the product in accordance with the derating curve shown below.

Horizontal separation of 15 mm or more

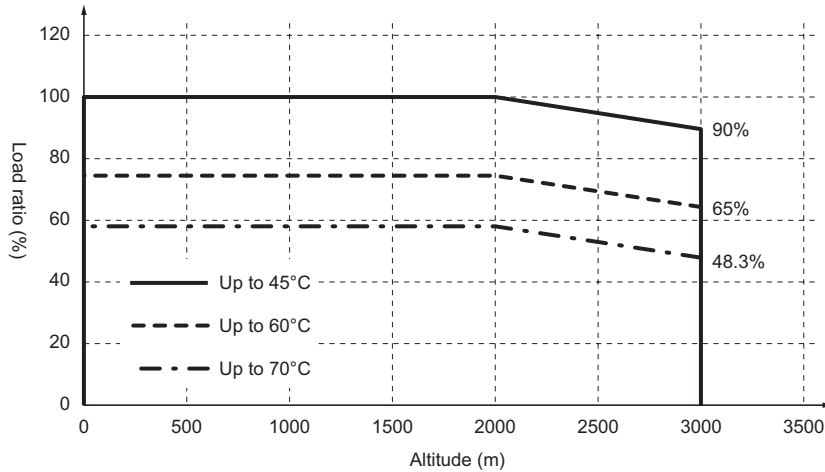

2. When operating the product, please apply the load reduction factor corresponding to the input voltage in addition to the load factor indicated by the above output derating.

### Load Reduction Coefficient Based on Input Voltage

#### ●S8NR-S36024-A□L□-IL3

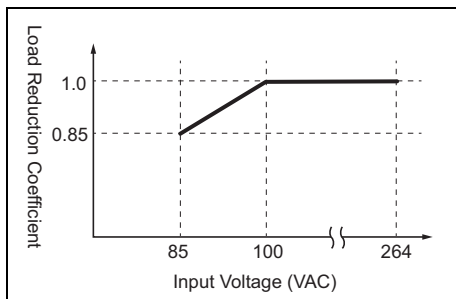

#### ●S8NR-S60024-A□L□-IL3

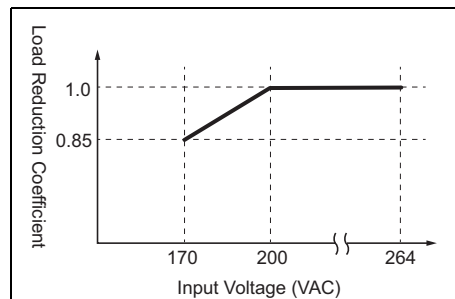

### ● Input Voltage Tolerance

360W

- Rating: 100 to 240 VAC
- Allowable AC input range: -15 to +10% (85 to 264 VAC)
- When using an input voltage less than 100 VAC, reduce the load calculated with derating 1%/V.

600W

- Rating: 200 to 240 VAC
- Allowable AC input range: -15 to +10% (170 to 264 VAC)
- When using an input voltage less than 200 VAC, reduce the load calculated with derating 0.5%/V.

### ● Abnormal Voltage Tripping

1. The S8NR-S has an abnormal voltage tripping function. When the output voltage exceeds the set value, all branch outputs are shut off. However, this function does not protect the load or internal parts from high voltages in all situations. Use the output voltage within the rated range.
2. Outputs may be cut off by the abnormal voltage protection with loads that generate reverse peak electromotive force.

### ● Abnormal Current Tripping

The S8NR-S has an abnormal current tripping function. A branch output will be cut off if its current exceeds a preset value. Also, all branch outputs will be cut off if their total peak output current exceeds a specified value.

- Note
1. Continuing operation with overcurrent may occasionally result in deterioration or destruction of internal elements.
  2. Do not use the Power Supply Unit for applications in which load inrush current or overload will frequently occur. Doing so may result in deterioration or damage to internal components.

### ● Maintenance Forecast Monitor Function

The accuracy of the maintenance forecast monitor function and the accumulated operating time may be reduced in applications where the AC input turns ON and OFF frequently.

Under general usage conditions, the S8NR-S will reach the replacement notification threshold in a few years to over a decade.

For long-term use, regularly check that the replacement period does not fall below 0.5 years by monitoring the display or by confirming it through communication.

### ● Startup Sequence and Shutdown Sequence Function

When using multiple units of this product, the sequence function is guaranteed between branch outputs within a single unit, but time synchronization between units cannot be achieved.

### ● Dielectric Strength Test

The S8NR-S is designed to withstand 2,000 VAC for 1 minute between <Input terminals pins 1 and 3 collectively> and <PE, branch output terminals, and IO-Link communications terminals pins 2,3,and 4 collectively>. When performing the withstand-voltage test, set the cutoff current of the hipot tester to 20 mA. (See page 2-2, page 2-3)

- Note
1. The S8NR-S may possibly be damaged from the impulse voltage if a testing device switch is used to abruptly apply or shut off 2,000 VAC. Increase the applied voltage gradually using the voltage adjustment on the testing device.
  2. When testing terminals together, always short the specified terminals so that the voltage is applied to all of the terminals at the same time.

### ● Insulation Resistance Test

When testing the insulation resistance, use a DC resistance meter at 500 VDC.

- Note
- During the test, short-circuit all branch output terminals (+, -) and communication terminals to prevent damage to the product.

### ● No Output Voltage

The internal circuit's overcurrent protection or overvoltage protection may operate. Alternatively, the latch protection circuit may operate if there is a lightning surge or other large voltage applied to the input. Contact OMRON if there is still no output voltage after checking the following two points:

- **Checking Overcurrent Protection**  
Check whether the load is in an overcurrent or short-circuited state. Remove the wires to the load before checking.
- **Checking Overvoltage Protection and Latching Protection**  
Turn the power supply OFF and leave it OFF for at least 3 minutes, then turn it ON again.

### ● Displaying the Output Voltage

The voltage detection function monitors the voltage inside the circuit after AC/DC conversion.

The displayed voltage will differ slightly from the value at the power supply output terminals due to internal voltage drop.

To accurately confirm the output voltage, measure the voltage at the output connector.

### ● Prohibition of Parallel Connection

Do not connect branch outputs from the S8NR-S (360/600W) in parallel. Also, do not connect the branch outputs in parallel with branch outputs of other S8NR-S Units.

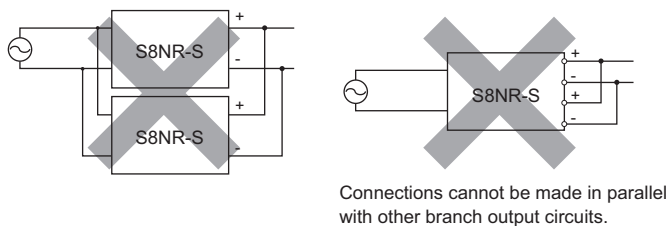

### ● Mounting Bracket (Optional)

Always use the screws provided as accessories.

Recommended tightening torque for mounting screws: 0.5 to 0.6 N·m

### ● Disposal

When disposing of the item, treat the S8NR-S as industrial waste.

● **Inrush Current □ Startup Time □ Output Hold Time**

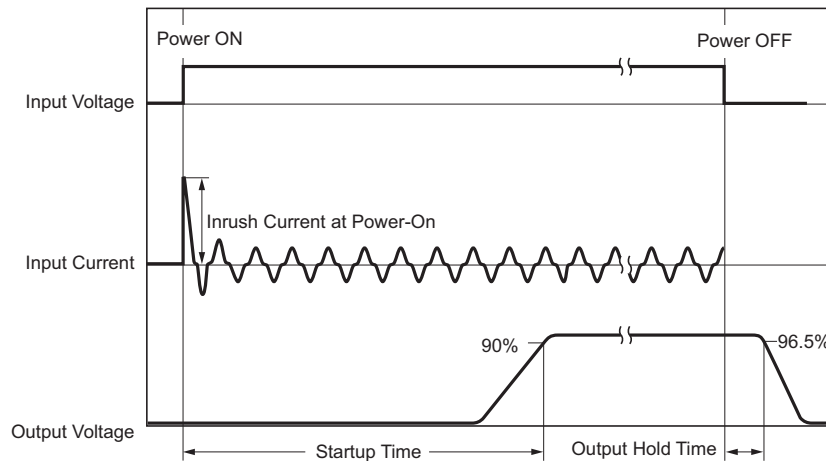

When using N units connected with jumper wires, the inrush current will be N times that of a single unit. To prevent external fuses from blowing or breakers from failing to operate due to inrush current, confirm the fuse's melting characteristics and the breaker's operating characteristics before selection.

● **Total Peak Output Current**

The S8NR-S is designed to provide a temporary peak current to provide the overcurrent required to start load devices. The total peak output current for all branch outputs combined is given below. If the total current exceeds any of these values, all branch outputs will be cut off according to the size of the peak current or application time to ensure safety.

1. 360-W Models

Peak current/Peak current pulse width:

- 30 A max. for 1 s max.
- 26 A max. for 2 s max.
- 22.5 A max. for 5 s max.
- 19.5 A max. for 10 s max.
- 18 A max. for 20 s max.

2. 600-W Models

Peak current/Peak current pulse width:

- 43.5 A max. for 2 s max.
- 37.5 A max. for 5 s max.
- 32.5 A max. for 10 s max.
- 30 A max. for 20 s max.

- Note
1. If the total output current exceeds the maximum peak current value, internal operation will become unstable and the branch outputs may be cut off.
  2. Maintain the total current for normal operation after the load devices have started to within the rated ranges.

### ● Connectors and Cables

Install using a torque not exceeding the specified value.

- The proper tightening torque for M12 connectors is 0.39 to 0.49 N·m.
- For M12 Smart Click connector engagement, securely tighten by hand until the engagement completion mark is reached. (See page 3-6)
- Always turn off the power before connecting or disconnecting connectors.
- Do not forcibly bend or pull the cable. Do not place heavy objects on the cable sheath, as this may cause disconnection.

### ● Conformance to EU and UK Directives

Refer to the datasheet and instruction manual for details on the operating conditions for EMC compliance.

Warning: When IO-Link Communication is used, the S8NR-S is Class A product. In a residential, commercial, or light industrial environment, it may cause radio interference. The S8NR-S is not intended to be installed in a residential environment. In a commercial or light industrial environment with connection to a commercial power supply, the user may be required to take adequate measures to reduce interference.

Compliance with Safety Standards is as follows:

### ● EN/IEC 62477-1

- Overvoltage Category III (up to 2000 m)  
Overvoltage Category II (more than 2000 m and up to 3000 m)
- Device Protection Class 1
- Atmospheric Conditions: 3K3

### ● Ambient temperature/ Surrounding Air Temperature

Max. 70°C at 58.3% load, 45°C at 100% load

(>45°C Load derating: 1.67%/K)

### ● Pollution degree

Usable in environments with Pollution Degree 3.

### ● Conformance to RCM

The Power Supply complies with RCM as an industrial device.

# Using this Manual

---

- **Notation in this Manual**

In this manual, the S8NR-S Environment-resistant IP67 Power Supply is referred to as the S8NR-S.

- **Notation of Setting Data**

Setting data codes and contents are displayed in eleven-segment display characters, as shown in the following diagram.

<i>R</i>	<i>b</i>	<i>l</i>	<i>d</i>	<i>E</i>	<i>F</i>	<i>G</i>	<i>H</i>	<i>l</i>	<i>J</i>	<i>K</i>	<i>L</i>	<i>M</i>
A	B	C	D	E	F	G	H	I	J	K	L	M

<i>N</i>	<i>ō</i>	<i>P</i>	<i>Q</i>	<i>R</i>	<i>S</i>	<i>t</i>	<i>U</i>	<i>V</i>	<i>W</i>	<i>x</i>	<i>Y</i>	<i>Z</i>
N	O	P	Q	R	S	T	U	V	W	X	Y	Z

# Revision History

---

A manual revision code appears as a suffix to the catalog number on the front cover of the manual.

<b>Man.No.</b>	<b>T245-E1-01</b>
----------------	-------------------

↑  
Revision code

Revision code	Date	Revised content
01	April 2026	Original production

# CONTENTS

---

Preface .....	1
Terms and Conditions Agreement .....	2
Safety Precautions .....	4
Precautions for Safe Use .....	5
Precautions for Correct Use .....	8
Using this Manual .....	14
Revision History .....	15
CONTENTS .....	16

## Section 1 Features and Functions

---

1-1 Overview of Features and Functions .....	1-2
1-2 S8NR-S Operating Modes .....	1-8
1-3 Table of Basic Functions .....	1-10
1-4 S8NR-S Operating Procedure .....	1-14

## Section 2 Specifications and Functions

---

2-1 Component Names and Functions .....	2-2
2-2 Internal Configuration .....	2-8
2-3 Specifications .....	2-11
2-4 Basic Function Details .....	2-15
2-4-1 Voltage Monitoring and Protection Functions .....	2-15
2-4-2 Over-current Protection Functions .....	2-17
2-4-3 Output Voltage Adjustment Function .....	2-22
2-4-4 Remaining Output Current Function .....	2-23
2-4-5 Stress Level Function .....	2-24
2-4-6 Standby Function .....	2-24
2-4-7 Maintenance Forecast Monitor Function .....	2-25
2-4-8 Total Run Time .....	2-27
2-4-9 Pre-alarm Function .....	2-27
2-5 Startup Sequence Function .....	2-28
2-6 Shutdown Sequence Function .....	2-29
2-7 External Tripping Input Function via Communication .....	2-30

## Section 3 Installation and Wiring

---

3-1	Installing the S8NR-S .....	3-2
3-2	Installation.....	3-3
3-3	Smart Click Connection Method .....	3-6
3-4	Connector Wiring .....	3-7

## Section 4 Parameter Settings

---

4-1	Parameter Table.....	4-2
4-2	Monitor Mode Parameters .....	4-4
4-3	Setting Mode Parameters .....	4-7

## Section 5 IO-Link Communication

---

5-1	IO-Link Indicator .....	5-2
5-2	IO-Link Communication Index List .....	5-3

## Section 6 Trial Operation to Actual Operation

---

6-1	Trial run .....	6-2
6-2	Connection/Disconnection Test.....	6-3

## Section 7 Error Processing

---

7-1	Troubleshooting .....	7-2
7-2	Eleven-segment Error Codes .....	7-4
7-3	Clearing Errors .....	7-6





# 1

## Features and Functions

---

---

<b>1-1 Overview of Features and Functions</b> .....	<b>1-2</b>
<b>1-2 S8NR-S Operating Modes</b> .....	<b>1-8</b>
<b>1-3 Table of Basic Functions</b> .....	<b>1-10</b>
<b>1-4 S8NR-S Operating Procedure</b> .....	<b>1-14</b>

# 1-1 Overview of Features and Functions

The environment-resistant IP67 power supply S8NR-S integrates a power supply and an electronic circuit protector, and it is a power supply for installation outside control panels that reduces wiring and provides high maintainability.

It supports multiple outputs and supplies a stable 24 VDC power with a maximum branch output current of 10 A per channel.

It is equipped with an IO-Link communication function, which enables monitoring and setting of various parameters and ON/OFF switching of channels.

## Model Number Legend

### Model Number Structure

S8NR -     -     -

Series name    1            2            3            4            5

#### 1 Input voltage

Symbol	Input voltage
S	Single-phase input

#### 2 Capacity

Symbol	Capacity
360	360 W
600	600 W

#### 3 Output voltage

Symbol	Output voltage (DC)
24	24 V

#### 4 Number of output connectors

Symbol	Number of output connectors
A0L2	M12 A Code: 1 M12 L Code: 0
A2L1	M12 A Code: 0 M12 L Code: 2
A0L3	M12 A Code: 0 M12 L Code: 3
A2L2	M12 A Code: 2 M12 L Code: 2

#### 5 IO-Link

Symbol	Transmission speed
IL3	IO-Link (COM3: 230.4 kbps)

## Waterproof Performance and Usability of the Environment-resistant IP67 Power Supply S8NR-S

The environment-resistant IP67 power supply S8NR-S is designed to maintain reliability in harsh environments. Its waterproof performance provides complete dust protection and resistance to water immersion up to a depth of 1 meter for 30 minutes. This allows use in outdoor locations and humid environments and meets the needs of various industries.

### ● Ease of Installation and Connection

- **Smart click connection:**  
It is equipped with a smart click function that enables simple connection and allows quick installation.
- **M12 Output Connectors:**  
It uses M12 output connectors that support market trends and customer standard specifications.
- **Installation outside control panels:**  
The IP67 waterproof performance allows safe installation outside control panels and provides flexible installation options.

### ● Ease of Setting

- **CP setting for each circuit:**  
You can set the cutoff current for each circuit, which allows flexible operation.
- **Fine settings:**  
It allows cutoff current settings in 0.1 A increments and startup sequence settings in 0.1 s increments to provide precise control.

### ● Ease of Confirmation

- **LED indicators:**  
You can easily check normal operation and errors with LEDs, which allows quick troubleshooting.
- **Monitor function:**  
You can check setting details, operating status, and error information on a monitor, which improves operational visibility.

## Power Supply and Branch Outputs

The power supply section incorporates the AC-DC conversion circuit of the S8NR-S Environment-resistant IP67 Power Supply which achieves high conversion efficiency in order to produce stable 24-VDC power.

The branch output circuits consist of the protection circuits and tripping circuits that inherit the performance of the S8M Digital Circuit Protector. They support various safety functions, such as overvoltage protection, overcurrent protection, and short-circuit protection, as well as maintenance functions, such as monitoring using the eleven-segment display and error indications.

## Branch Output Tripping Circuits

### ● No-contact Switching

The S8NR-S built-in circuit protectors differ from conventional mechanical contact-type circuit protectors in that they use no-contact power MOSFET switching.

Without the contact life of mechanical circuit protectors, semiconductor relays are able to provide a much longer lifetime. Digital processing also provides other benefits, such as being able to specify detailed overcurrent detection conditions.

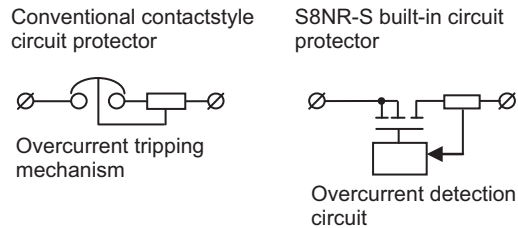

### ● Tripping Current Can be Set for Each Branch Output

The abnormal tripping current value can be set for each branch output.

The setting range differs depending on the output connector.

Setting range
M12-A: 0.5 to 3.8 A
M12-L: 0.5 to 10.0 A

Tolerance of current tripping threshold:  $\pm 0.3$  A.

### ● Abnormal Current Detection and Tripping Time

The abnormal current tripping characteristics can be set for each branch output.

There are three methods that can be used to determine abnormal current trippings.

- Standard Detection  
When the current exceeds the set value, the branch output is cut off within 100 ms.
- Instantaneous Detection  
When the current exceeds the set value, the branch output is cut off within 20 ms.
- Extended Detection  
When the current exceeds the set value, the branch output is cut off within 1,000 ms.

### ● Error Indication for Abnormal Current Tripping

The following will occur when an abnormal current is detected and the branch output is cut off:

- The channel ON/OFF key of the branch output will light red.
  - The eleven-segment display will show the error code A11 and the abnormal current value alternately.
- Always remove the cause of the abnormal current before resetting the alarm.

### ● Tripping for Total Peak Output Current

When the total branch output current exceeds the set value for a specified amount of time, all branch outputs will be cut off.

- The channel ON/OFF keys of all branch output will light red.
- The eleven-segment display will flash the error code A12.

### ● Abnormal Voltage Tripping

If the output voltage exceeds the abnormal voltage tripping setting, all branch outputs will be cut off in order to protect load devices.

The following will happen when this occurs:

- The eleven-segment display will show the error code A10 and the abnormal voltage alternately.

## Maintenance Forecast Monitor Function

---

This function calculates the condition of the electrolytic capacitor based on the power-ON time and internal temperature of the Power Supply to forecast when the Power Supply needs to be replaced. The monitor value can be set to between 0.0 and 5.0 years (approximate) in increments of 0.1 years.

The following occurs when the estimated replacement time reaches the set value:

- The eleven-segment display will show the error code A23 and the replacement time (years) alternately.

Also, the monitor value can be set not by the number of years but also by the percentage (%) up to the estimated replacement time.

## Safety Functions

---

If an abnormal voltage or current is detected, the power MOSFET will cut off the branch output. In the unlikely event that the power MOSFET cannot cut off an abnormal current or short-circuit current, the short-circuit protection fuse will cut the circuit to protect the system.

When cutoff occurs due to a fuse, the S8NR-S displays E94 on the eleven-segment display. The overcurrent protection fuse or over-temperature fuse cannot be replaced. If a fuse burns out, use a different branch output or replace the S8NR-S.

## Additional Functions

### ● Startup Sequence Function

A delay can be set for the connection of the branch outputs. When you want to apply a startup delay to the branch output, it is not necessary to construct an external sequence circuit. The inrush current can be suppressed by applying a delay and the Power Supply Unit's load can be reduced. (For details, refer to *2-5 Startup Sequence Function* on page 2-28.)

### ● Shutdown Sequence Function

The branch outputs' cutoff can be delayed. When you want to apply a shutdown delay to the branch output, it is not necessary to construct an external sequence circuit. (For details, refer to *2-6 Shutdown Sequence Function* on page 2-29.)

### ● Protecting Parameter Settings (Protection Level Settings)

The Protection Level can be set to restrict access to the parameters. Four levels, levels 0, 1, 2, and 3, are available. This function can be used to prevent parameters from being changed or deleted inadvertently.

Protection level	Restrictions
0	You can read and change all parameters.
1	You can read and change only operation settings related to voltage and current.
2	Parameter reading is restricted, and all change operations are prohibited.
3	You can set parameters only via IO-Link communication. You can operate only display switching in Monitor Mode and the key lock function. The Setting Mode is hidden, and operation of the Mode switch key, Enter key, Reset (RST)/Cancel (ESC) key, and channel ON/OFF keys is disabled. Note Do not set protection level 3 in Setting Mode. You cannot switch to Monitor Mode by key operation.

The default setting is protection level 1. (For details, refer to *Protection level* on page 4-12.)

## Communication Features

The S8NR-S supports IO-Link communication. Even when there is no AC input, you can check and set parameters by using only the power supplied from the IO-Link master.

You can set the functions\*1 of the S8NR-S by key operation (display), but some functions are supported only by IO-Link communication, as shown below.

\*1. For details on each function, refer to *1-3 Table of Basic Functions* on page 1-10.

### ● Internal Temperature Monitoring

The S8NR-S has a built-in temperature sensor and constantly measures the internal temperature. It has a temperature alarm function that allows you to set alarms based on the measured internal temperature.

### ● Cutoff Function by External Signal from Communication

You can forcibly cut off branch outputs by turning ON the external signal cutoff input via IO-Link communication.

- Only branch outputs for which the external tripping input is set to “Enable” in the IO-Link communication settings are subject to cutoff. (Refer to *5-2 IO-Link Communication Index List* on page 5-3, Index 124 (page 5-9).)
- Because cutoff by the external tripping input directly cuts off the DC circuit side, the cutoff speed is faster than normal cutoff by AC power input.
- When a shutdown sequence is set, time-delayed cutoff for individual branch outputs is possible. (Refer to *2-6 Shutdown Sequence Function* on page 2-29.)
- You can set the type of tripping input by the external tripping input function setting in the IO-Link communication settings. (Refer to *2-7 External Tripping Input Function via Communication* on page 2-30.)
  - EGE (0): Cutoff occurs on the rising edge of the cutoff input (OFF → ON transition).
  - LVL (1): Cutoff occurs on the rising edge of the cutoff input (OFF → ON transition), and reconnection occurs on the falling edge (ON → OFF transition).

## 1-2 S8NR-S Operating Modes

The S8NR-S has 2 operating modes: Monitor Mode and Setting Mode.

You can switch the operating mode by pressing and holding the mode switch key for 3 seconds.



24 VDC power is supplied to the branch outputs in both modes (branch outputs are connected). Also, the output voltage, output current, internal temperature, and run time are monitored at all times.

Mode name	Description
Monitor Mode	This mode is used during normal operation. The monitored values (voltage, current, etc.) of each branch output can be displayed on the eleven-segment display. The S8NR-S automatically starts up in this Monitor Mode when it is used for the first time.
Setting Mode	This mode is used to change the settings of the various parameters.

For details on how to display parameters in the Monitor Mode, refer to *4-2 Monitor Mode Parameters* on page 4-4.

For details on how to set parameters in the Setting Mode, refer to *4-3 Setting Mode Parameters* on page 4-7.

### Automatic Operation after Power ON and Power OFF

When the rated voltage is applied to the AC input terminal block, the branch output indicators, eleven-segment display, and unit indicators all light, and then connection of each branch output is initiated. Also, if the startup sequence function (refer to page 2-28) has been set, each of the branch outputs will be connected according to their corresponding settings. When the power is turned OFF, the lower segment of the branch output indicators lights and the product shuts down.

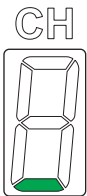





## Operation in Monitor Mode

In Run Mode, the S8NR-S continuously measures the output voltage, and branch output circuit currents, and compares these values to the set values (both user-set parameters and system set values).

### ● Monitor Operation

The monitored output voltage, branch output currents, branch output peak current, total current, and replacement time can be read on the S8NR-S's eleven-segment display.

The displayed value on the eleven-segment display can be switched with the channel down  /up  keys and selection down  /up  keys.

### ● Tripping Operation

If the voltage or current is abnormal, the branch output will be cut off to protect the circuit.

- Abnormal Voltage Tripping

If the output voltage exceeds the abnormal voltage tripping setting, all branch outputs will be cut off in order to protect the load devices.

- Abnormal Current Tripping Operation

A branch output will be cut off if an abnormal current is detected using the tripping current threshold or the current detection method specified for each individual branch output.

When cutoff occurs, the abnormal status is displayed and notification is sent by an IO-Link communication event.

### ● Optional Cutoff Operation

You can cut off a circuit by pressing and holding the channel ON/OFF key (green LED lit) installed for each branch output for 3 seconds. The LED turns OFF.

Press and hold the key again for 3 seconds to reconnect the circuit (green LED lit).

After abnormal cutoff (when the LED changes from flashing red to lit red), press and hold the key again for 3 seconds to reconnect the circuit (green LED lit) and clear the abnormal indication.

This function allows you to cut off and reconnect only the branch output where an abnormality occurs, so you do not need to stop other branch outputs during recovery work.

### ● Other Status Monitoring

The internal temperature and replacement time status are monitored and error processing is performed if an error is detected.

## Operation in Setting Mode

Setting Mode can be used to set the various parameters. The S8NR-S is in operating status when it is in Setting Mode. Branch outputs are connected in Setting Mode in the same way as in Monitor Mode.

When an error is detected, branch outputs will be cut off, just as they are in Monitor Mode.

Note If an error occurs in Setting Mode, the error code is not displayed.

## 1-3 Table of Basic Functions

### Monitor Functions

The following table shows the display order of parameters.

Parameter name	Details	Display	Communication
Output voltage (Index 79 Present output voltage)	Displays the output voltage.	Yes	Yes
Output current (Index 84 Output current)	Displays the current value of each branch output.	Yes	Yes
Total current (Index 81 Total current)	Displays the total current value of all the branch outputs.	Yes	Yes
Peak current (Index 89 Peak output current)	Displays individual branch output peak currents.	Yes	Yes
Remaining output current (Index 90 Remaining output current)	This value displays how much additional current can be supplied for each branch output.	Yes	Yes
Years up to replacement time (Index 67 Years until replacement)	Displays the remaining number of years up to the replacement time by forecasting the replacement time of the S8NR-S.	Yes	Yes
Percentage up to replacement time (Index 68 Percentage until replacement)	Displays the remaining percentage up to the replacement time by forecasting the replacement time of the S8NR-S.	Yes	Yes
Total running time (Index 73 Total operating time)	Displays the total running time of the S8NR-S.	Yes	Yes
Temperature (Index 69 Internal temperature)	Displays the internal temperature of the S8NR-S.	No	Yes

For details, refer to *4-2 Monitor Mode Parameters* on page 4-4.

### Setting Functions

The following table shows the display order of parameters.

Parameter name	Details	Display	Communication
Output Voltage Setpoint (Index 105 Output Voltage Setpoint)	The output voltage can be adjusted. The adjustment range is 24.0 to 28.0 V.	Yes	Yes
Abnormal current tripping threshold (Index 108 Current tripping threshold)	The current tripping threshold can be set for each branch output in 0.1-A increments.	Yes	Yes
Abnormal current tripping type (Index 107 Current tripping type)	The tripping type can be set for each branch output. USU: Standard (tripping within 100 ms) INS: Instantaneous (tripping within 20 ms) LNG: Extended (tripping within 1,000 ms)	Yes	Yes

Parameter name	Details	Display	Communication
Abnormal voltage tripping threshold (Index112 Abnormal voltage tripping threshold)	The abnormal voltage tripping threshold can be set for the output voltage.	Yes	Yes
Undervoltage detection threshold (Index114 Undervoltage detection threshold)	The undervoltage detection output (A21) is output when the output voltage of the S8NR-S falls below this detection threshold. An event is also output via IO-Link communication. The detection threshold can be set in 0.1-V increments. Branch outputs will not be cut off.	Yes	Yes
Years threshold until replacement (Index 116 Years threshold until replacement)	This value sets the planned replacement period for the S8NR-S unit. When the value falls below the set threshold, the Yrs indicator lights steadily. An event is also output via IO-Link communication.	Yes	Yes
Maintenance forecast percentage threshold (Index 117 Percentage threshold until replacement)	This value sets the planned replacement percentage for the S8NR-S unit. When the value falls below the set threshold, the % indicator lights steadily. An event is also output via IO-Link communication.	Yes	Yes
Running time alarm threshold (Index 118 Total operating time threshold)	This value sets the running time alarm threshold for the S8NR-S unit. When the running time exceeds this threshold, the kh indicator lights steadily. An event is also output via IO-Link communication.	Yes	Yes
Temperature alarm threshold (Index 115 Over-temperature output threshold)	You can set a temperature alarm by detecting an increase in the internal temperature of the S8NR-S.	No	Yes
Startup sequence (Index 110 Startup sequence)	When connection of branch outputs is initiated when the power is turned ON, a time delay can be set for each individual branch output. Connecting the branch outputs in sequence instead of simultaneously can reduce the inrush current and reduce the load on the Power Supply.	Yes	Yes
Shutdown sequence (Index 111 Shutdown sequence)	You can set a time delay for cutoff when branch outputs are cut off by the external tripping input trip via communication.	Yes	Yes
Tripping trigger enable/disable Index 124 External tripping input cutoff for branch	You can set whether to enable (ON) or disable (OFF) the external tripping input trip via communication for each branch output.	No	Yes
Tripping trigger type (Index 123 External tripping input function setting)	The tripping trigger type can be set for all branches that have the tripping input function enabled.	No	Yes
Reset function setting (Index 119 Alarm reset setting)	The tripping alarm output and alarm output can be cleared after removing the cause of the alarm by the following two methods. <ul style="list-style-type: none"> <li>• KEY: RST Key only.</li> <li>• ALL: RST Key or turning power OFF and ON again.</li> </ul>	Yes	Yes
Protection level (Index 102 Protection level)	The Protection Level function can restrict parameter read/write access by setting one of four levels. The default protection level is level 1.	Yes	Yes

Parameter name	Details	Display	Communication
Channel ON/OFF key enable/disable (Index 103 CH Key)	Although connection/disconnection can be switched by the channel ON/OFF key, this function can be set to disabled to prevent malfunction. The default is "Enabled".	Yes	Yes
Initialize defaults (Index2 System-Command)	This is used to return all settings to their default states.	Yes	Yes

For details, refer to 4-3 *Setting Mode Parameters* on page 4-7.

## Tripping/Alarm Functions

There are three ways for the S8NR-S's tripping function to operate:

- Tripping by user by channel selection key
- Tripping by the S8NR-S's system monitor
- Tripping by IO-Link communication

When cutoff occurs or an alarm is generated, notification is provided by display on the eleven-segment display and by an IO-Link communication event.

### ● Tripping Functions

Setting	Operating range	Parameter settings	Outputs cut off
Abnormal Voltage Tripping	Tripping when the output voltage exceeds the abnormal voltage tripping setting	Yes	All branch outputs
Short-circuit current tripping	The cutoff current value depends on the output connector. M12-A: Cutoff occurs at 16 A within 20 ms, or at 11 A within 60 ms. M12-L: Cutoff occurs at 16 A within 20 ms, or at 13 A within 60 ms.	None	External tripping input
Abnormal total current tripping	Output cut off when the sum of all branch output currents exceeds the set value for a specific length of time.	None	All branch outputs
Abnormal current tripping *1	The setting range differs depending on the output connector. M12-A: 0.5 to 3.8 A (in 0.1 A increments) M12-L: 0.5 to 10.0 A (in 0.1 A increments) Select from standard, instantaneous, and extended detection methods.	Yes	External tripping input
Cutoff by external signal input via IO-Link communication	Refer to Index 124: External tripping input cutoff for branch and Index 125: External tripping input in 5-2 <i>IO-Link Communication Index List</i> on page 5-3.	Yes	Specified output *2

\*1. The tripping function operates within 100 ms when the S8AS2 is set to standard detection, within 20 ms when it is set to instantaneous detection, and within 1,000 ms when it is set to extended detection.

\*2. The TRG signal applies only to the branch outputs for which the external tripping input is enabled. For details, refer to 2-7 *External Tripping Input Function via Communication* on page 2-30.

## ● Alarm Output Functions

Alarm name	Operation	Error code displayed	Event code
Abnormal voltage tripping	If the output voltage exceeds the abnormal voltage tripping setting, all branch outputs will be cut off. Notification is provided by the eleven-segment display and by an IO-Link communication event.	A10	0x181D
Branch output tripping	Abnormal Current Tripping Operation When the branch output current exceeds the set value, the branch output is cut off. Notification is provided by the eleven-segment display and by an IO-Link communication event.	A11/Current (alternating)	· Cutoff occurrence 0x180B to 0x1810
	Volt-ampereage (VA) Tripping Operation When the voltage times the current (VA) exceeds the set value for a specified amount of time, the branch output is cut off. Notification is provided by the eleven-segment display and by an IO-Link communication event.	A11/Current (alternating)	
Abnormal current tripping pre-alarm	When the current value of a branch output exceeds the set value [Current pre-alarm level], notification is provided by an event code.	-	· Pre-alarm occurrence 0x1813 to 0x1818
Abnormal total current tripping	When the total output current exceeds the set value, all branch outputs are cut off. Notification is provided by the eleven-segment display and by an IO-Link communication event.	A12	· Cutoff occurrence 0x1807
Total current pre-alarm	When the total output current exceeds the specified value [Total current pre-alarm level], notification is provided by an event code.	-	· Pre-alarm occurrence 0x180A
Undervoltage alarm	Setting range: 18.0 to 28.0 VDC (in 0.1 V increments). Notification is provided when the output voltage falls below the set value. Notification is provided by the eleven-segment display and by an IO-Link communication event.	A21/Voltage (alternating)	0x1806
Maintenance forecast monitor alarm	Notification is provided when the internally calculated replacement time falls below the set value. Notification is provided by the eleven-segment display and by an IO-Link communication event.	A23/Replacement time (alternating)	· Predictive maintenance power supply alarm 0x1809
Overheating alarm *1	Notification is provided when the internal temperature of the power supply increases and accurate calculation of the replacement time becomes impossible. Notification is provided by the eleven-segment display and by an IO-Link communication event.	A23/HOT (alternating)	0x181B
Temperature alarm	Setting range: 25 to 120 °C (set in 1 °C increments). Notification is provided when the temperature reaches or exceeds the set value. Notification is provided by an IO-Link communication event. The alarm is cleared when the temperature falls below the set value minus 3 °C.	A30/Temperature (alternating)	0x4210

\*1. If the overheating alarm stays on for more than 3 hours, the abnormal overheating state is reached ("E06" is displayed) and this alarm state can no longer be cleared. (Event code: 0x181C)

# 1-4 S8NR-S Operating Procedure

## Using the S8NR-S

- Typical Startup Procedure Using the S8NR-S's Keys

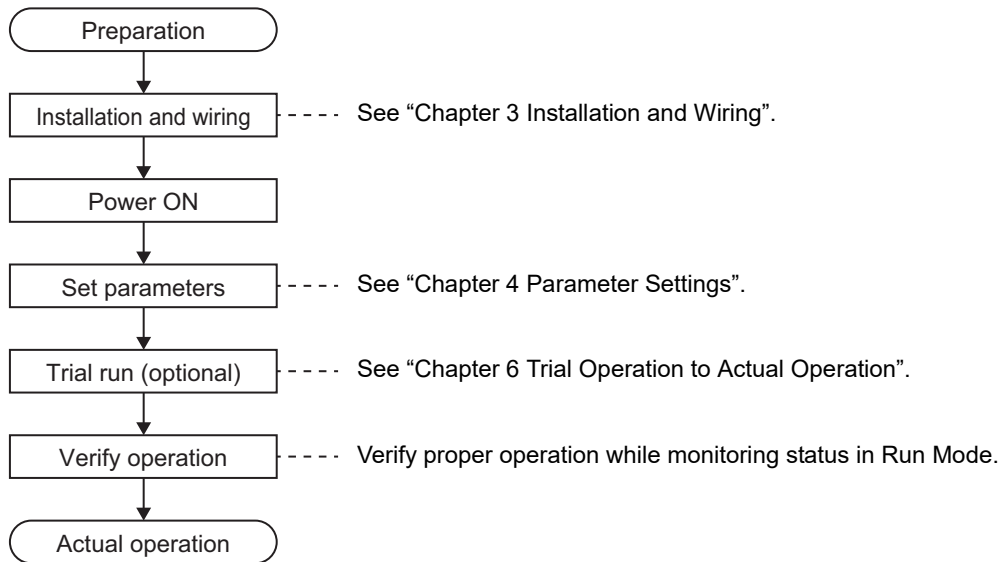

## Summary of Application Objectives and Settings

Desired objective/usage	Settings	Reference page
Use as a circuit breaker with overcurrent tripping.	In Setting Mode, set the abnormal current tripping threshold (C-V) for the branch output being used and set the abnormal current tripping detection setting (C-T) to standard detection (USU).	Page 2-17 Page 4-8
Use as a circuit breaker for short-circuit current protection.	In Setting Mode, set the abnormal current tripping threshold (C-V) for the branch output being used and set the abnormal current tripping detection setting (C-T) to instantaneous detection (INS).	
Apply a separate time lag when connecting each branch output.	In Setting Mode, set the startup sequence (UPS).	Page 2-28 Page 4-10
Apply a separate time lag when cutting off each branch output.	In Setting Mode, set the shutdown sequence (DWS) and enable Index 124: External tripping input cutoff for branch.	Page 2-29 Page 4-10
Use the S8NR-S replacement time for better maintenance.	By using the maintenance forecast monitor function, you can check the estimated replacement timing by notification on the eleven-segment display and by an IO-Link communication event (0x1809) at the scheduled time.	Page 2-25 Page 4-9
Restrict read/write access of parameters to prevent mistaken operations.	Select the protection level setting (PRT) from the Mode Selection Menu and set the desired protection level.	Page 4-2 Page 4-12

# 2

## Specifications and Functions

---

<b>2-1</b>	<b>Component Names and Functions</b>	<b>2-2</b>
<b>2-2</b>	<b>Internal Configuration</b>	<b>2-8</b>
<b>2-3</b>	<b>Specifications</b>	<b>2-11</b>
<b>2-4</b>	<b>Basic Function Details</b>	<b>2-15</b>
2-4-1	Voltage Monitoring and Protection Functions	2-15
2-4-2	Over-current Protection Functions	2-17
2-4-3	Output Voltage Adjustment Function	2-22
2-4-4	Remaining Output Current Function	2-23
2-4-5	Stress Level Function	2-24
2-4-6	Standby Function	2-24
2-4-7	Maintenance Forecast Monitor Function	2-25
2-4-8	Total Run Time	2-27
2-4-9	Pre-alarm Function	2-27
<b>2-5</b>	<b>Startup Sequence Function</b>	<b>2-28</b>
<b>2-6</b>	<b>Shutdown Sequence Function</b>	<b>2-29</b>
<b>2-7</b>	<b>External Tripping Input Function via Communication</b>	<b>2-30</b>

# 2-1 Component Names and Functions

This chapter explains the connectors and other displays and keys.

## Connectors

### ● S8NR-S36024-A2L1-IL3

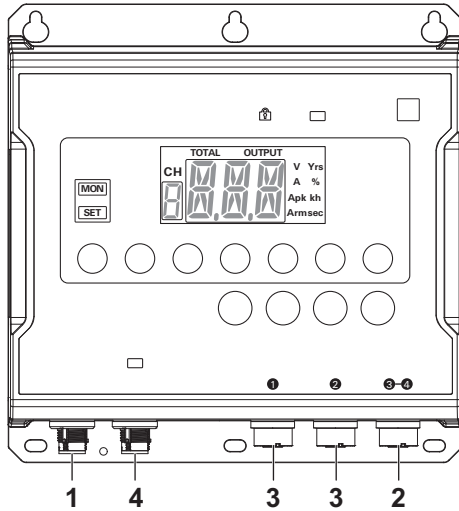

No.	Connector Name		Pin Assignment
1	Input Terminal M12-S (Plug)		PE:PE (Protective Earth) Terminal (⊕)
			1: Input Terminal (L)
			3: Input Terminal (N)
2	Output Terminals M12-L (Socket)		FE:FE (Functional Earth) Terminal (⊕)
			1: Branch Output Terminal (+) (1/2)
			2: Branch Output Terminal (-) (2/2)
			3: Branch Output Terminal (-) (1/2)
3	Output Terminals M12-A (Socket)		1: Branch Output Terminal (-) (Class 2 Output)
			2: NC
			3: Branch Output Terminal (-) (Class 2 Output)
			4: NC
			5: NC
4	IO-Link Communication Terminal M12-A (Plug)		1: L+
			2: No Pin
			3: L-
			4: C/Q

### ● S8NR-S36024-A0L2-IL3

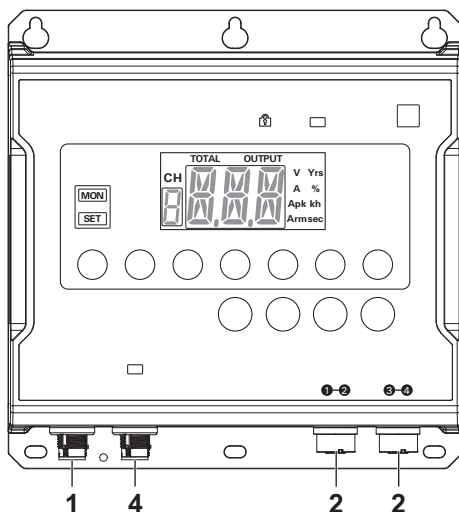

No.	Connector Name		Pin Assignment
1	Input Terminal M12-S (Plug)		PE:PE (Protective Earth) Terminal (⊕)
			1: Input Terminal (L)
			3: Input Terminal (N)
2	Output Terminals M12-L (Socket)		FE:FE (Functional Earth) Terminal (⊕)
			1: Branch Output Terminal (+) (1/2)
			2: Branch Output Terminal (-) (2/2)
			3: Branch Output Terminal (-) (1/2)
4	IO-Link Communication Terminal M12-A (Plug)		1: L+
			2: No Pin
			3: L-
			4: C/Q

● S8NR-S60024-A2L2-IL3

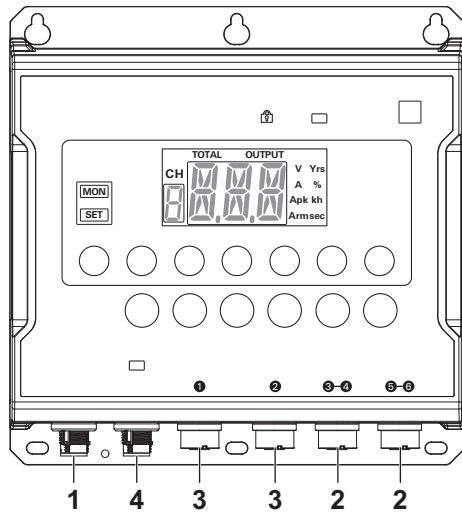

No.	Connector Name		Pin Assignment
1	Input Terminal M12-S (Plug)		PE:PE (Protective Earth) Terminal ( $\oplus$ )
			1: Input Terminal (L)
			3: Input Terminal (N)
2	Output Terminals M12-L (Socket)		FE:FE (Functional Earth) Terminal ( $\overline{L}$ )
			1: Branch Output Terminal (+) (1/2)
			2: Branch Output Terminal (-) (2/2)
			3: Branch Output Terminal (-) (1/2)
3	Output Terminals M12-A (Socket)		1: Branch Output Terminal (-) (Class 2 Output)
			2: NC
			3: Branch Output Terminal (-) (Class 2 Output)
			4: NC
			5: NC
4	IO-Link Communication Terminal M12-A (Plug)		1: L+
			2: No Pin
			3: L-
			4: C/Q

● S8NR-S60024-A0L3-IL3

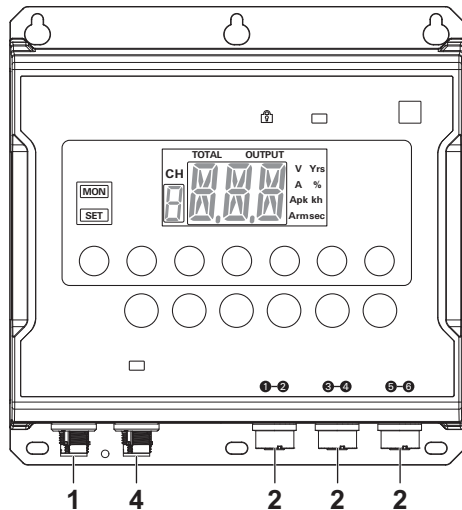

No.	Connector Name		Pin Assignment
1	Input Terminal M12-S (Plug)		PE:PE (Protective Earth) Terminal ( $\oplus$ )
			1: Input Terminal (L)
			3: Input Terminal (N)
2	Output Terminals M12-L (Socket)		FE:FE (Functional Earth) Terminal ( $\overline{L}$ )
			1: Branch Output Terminal (+) (1/2)
			2: Branch Output Terminal (-) (2/2)
			3: Branch Output Terminal (-) (1/2)
4	IO-Link Communication Terminal M12-A (Plug)		1: L+
			2: No Pin
			3: L-
			4: C/Q

## Component Names

●S8NR-S36024-□□□□-□□□

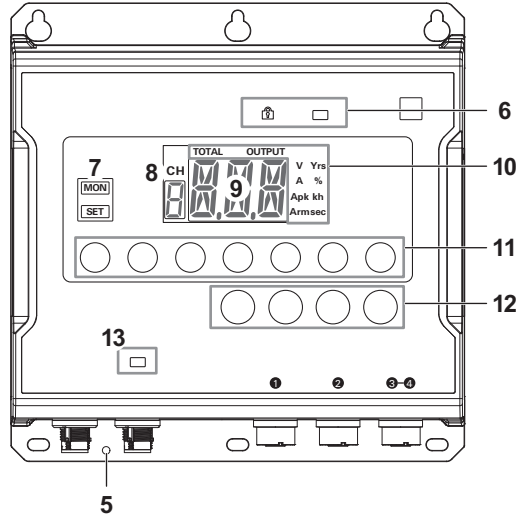

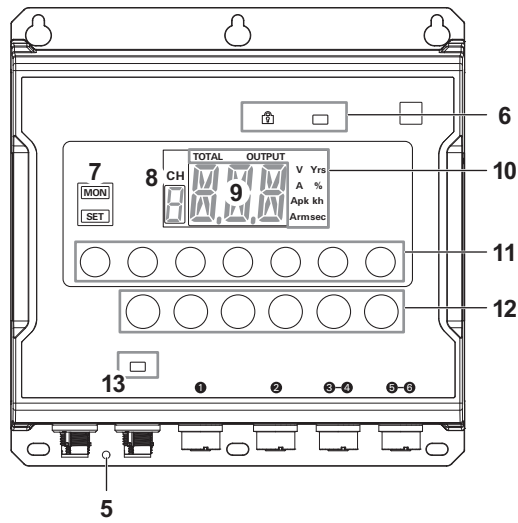

●S8NR-S60024-□□□□-□□□

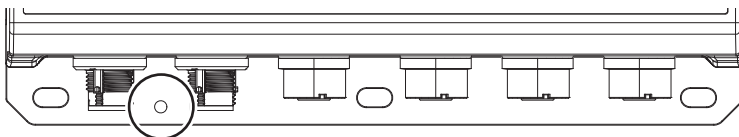

**5 Protective Earth (PE) Terminal** 

The protective earth required for safety is ensured only by the PE terminal of the input terminal (1). Use the PE terminal (5) as required.



**6 Key Lock Indicator** , **Output Indicator**

Key Lock Indicator : Lights when the S8NR-S is in the key lock state.

Output Indicator (DC OK):

Lights green when the S8NR-S is operating normally. When it is lit, the 24 VDC output voltage is available.



**7 Mode Display (MON/ SET)**

Displays the current mode (Monitor Mode/ Setting Mode).



**8 Branch Output Number Indicator (Green)**

Displays the currently selected branch output channel.

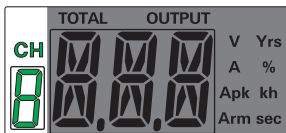

1 to 4: 360 W	Lit or flashing when the display is related to the corresponding branch output.
1 to 6: 600 W	

**9 Eleven-segment Display (White)**

Displays measured values or set values on a 3-digit LED display.

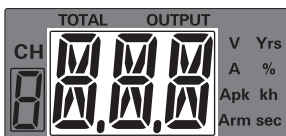

**10 Unit Indicators (Orange)**

Shows the unit for values shown in the eleven-segment display.

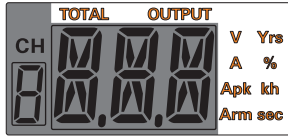

TOTAL	Lit when the total current is displayed.
OUTPUT	Lit when displaying the output current.
V	Lit when displaying the output voltage.
A	Lit when displaying the output current.
Apk	Lit when displaying the peak output current.
Arm	Lit when the remaining current is displayed.
Yrs	Lit when the number of years to the set replacement time is displayed.
%	Lit when displaying the percentage up to replacement time.
kh	Lit when displaying the total running time.
sec	Lit when setting the startup sequence time or shutdown sequence time.

**11 Operation Keys**

Mode Switch Key *1		Switches between Monitor Mode and Setting Mode.
Channel Down Key *1		Used to switch the branch output.
Channel Up Key		
Selection Down Key		Used to change the display item forward or to decrease a set value.
Selection Up Key		Used to change the display item backward or to increase a set value.
Enter Key		Used to switch the display item, enter or execute settings, etc.
Reset (RST)/ Cancel (ESC) Key		Used to clear the error status when a branch output was cut off by an error or there was an alarm output.

\*1. Press and hold the mode switch key and the channel down key simultaneously for 3 seconds to lock all keys. To release the key lock state, perform the same operation.

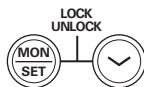

### 12 Channel ON/OFF Key

The connected/tripped state of each branch output is shown by an indicator.

Cutoff: red, Connection: green

You can switch each branch output between connection and cutoff by using the pushbutton switch.

For the 360W model, channels 1 to 4 are available.

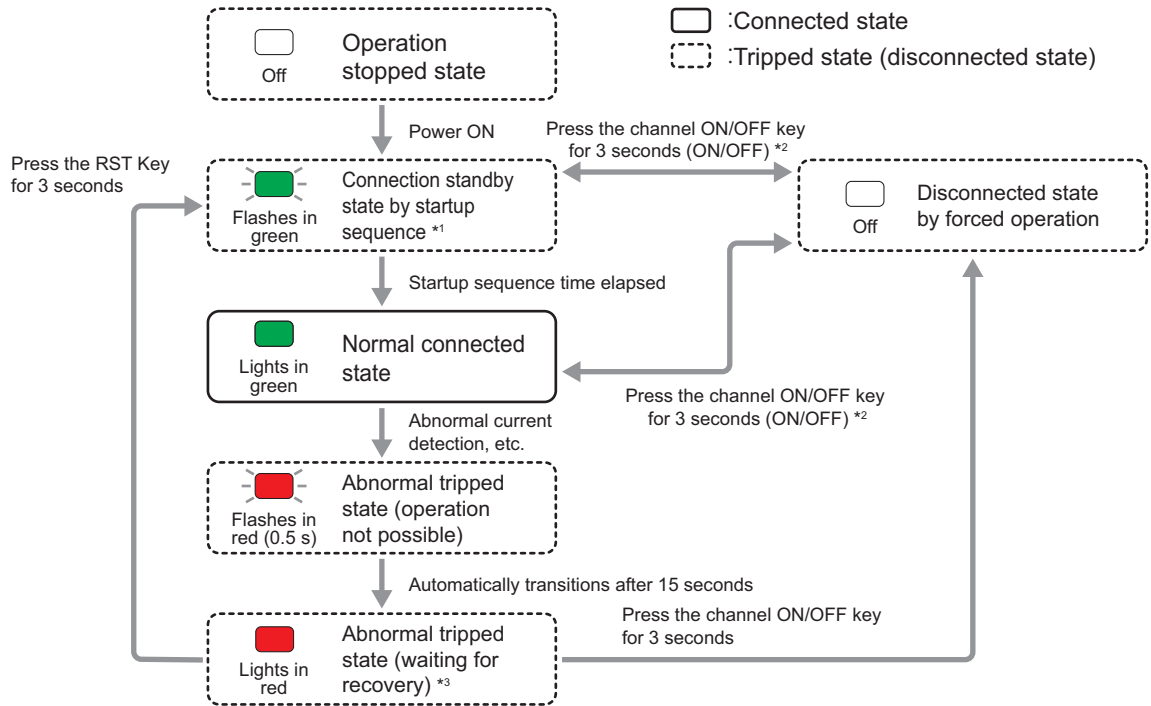

- \*1. When 0 s is set to the startup sequence, the branch output is connected normally without waiting for the connection.
- \*2. When ON/OFF operation is performed continuously, OFF is switched to ON only after at least 3 seconds have elapsed since the previous ON.
- \*3. If a tripped state occurs due to an internal error (waiting for recovery), the indicator flashes in red at 0.25 second intervals.

### 13 IO-Link Indicator (Red/ Green)

The indicator lights red when a product error occurs.

Under normal conditions, the indicator is OFF when communication is not established and flashes green after communication is established.

For details, refer to 5-2 IO-Link Communication Index List on page 5-3.



# 2-2 Internal Configuration

## ● S8NR-S36024-A0L2-IL3

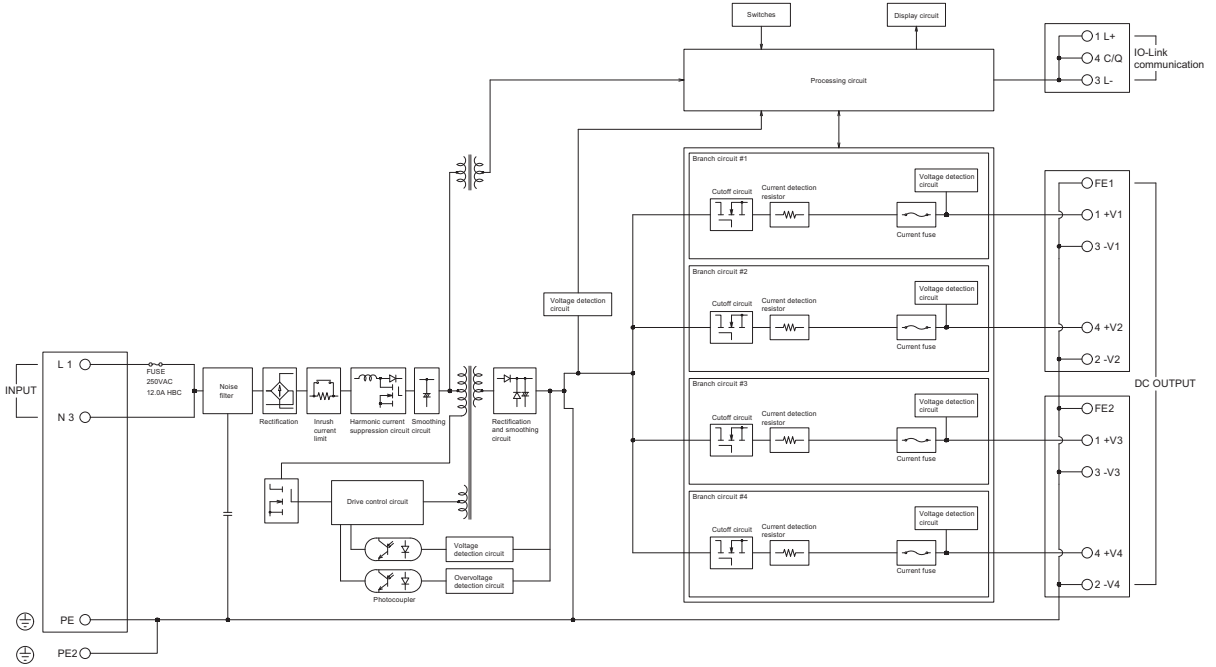

## ● S8NR-S36024-A2L1-IL3

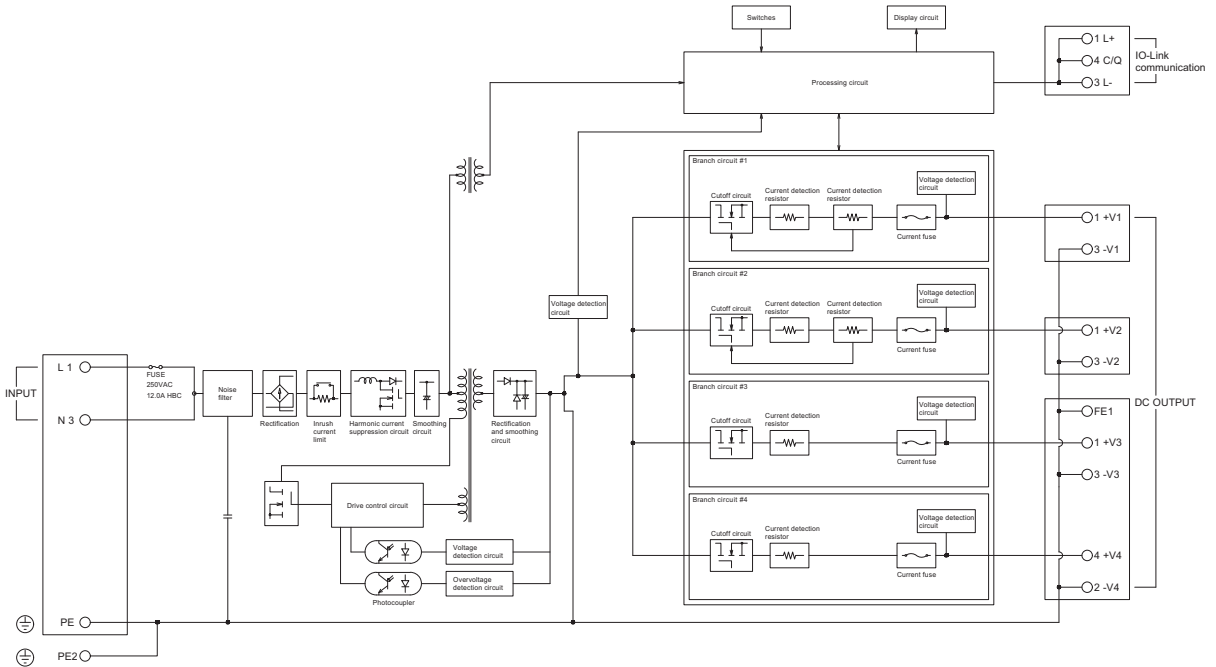

● S8NR-S60024-A0L3-IL3

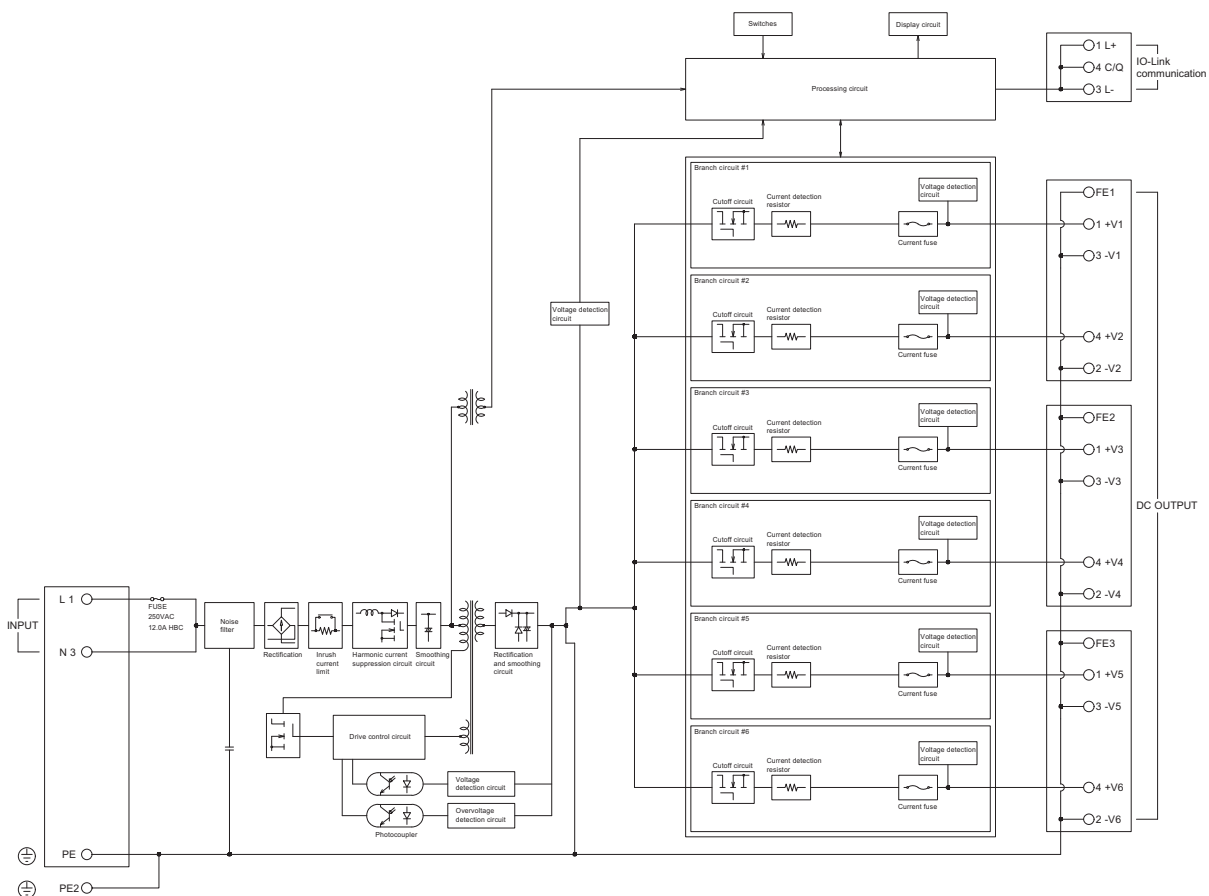

● S8NR-S60024-A2L2-IL3

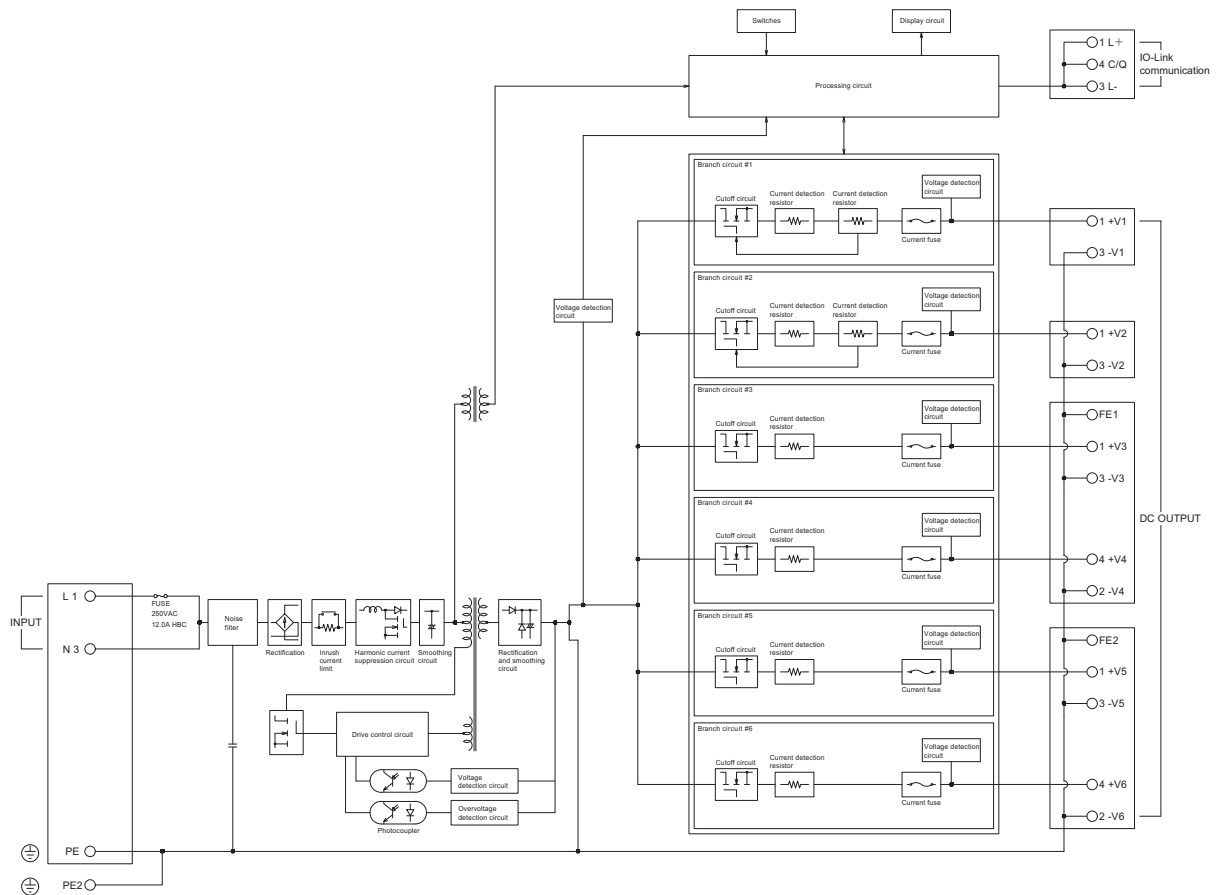

- The S8NR-S compares the measured output voltage, current, and internal temperature with the preset parameters. These values can be read on the S8NR-S's eleven-segment display.
- When an error is detected, the branch output will be cut off or an alarm will be output. Details of the abnormal condition are indicated on the eleven-segment display by the error code and the current value, or notified by an IO-Link communication event.
- When an abnormal voltage or current is detected, the power MOSFET will cut off the branch output. In the unlikely event that the power MOSFET cannot cut off an abnormal current or short-circuit current, the redundant protection circuit, and the short-circuit protection fuse will operate to protect the system.
- The S8NR-S has a built-in temperature sensor, which can detect a temperature rise inside the S8NR-S.

# 2-3 Specifications

## Ratings and Characteristics

● S8NR-S36024-A□L□-IL3

Model		S8NR-S36024-A0L2-IL3	S8NR-S36024-A2L1-IL3
Efficiency	100 VAC Input *1	92% typ. (Power supply section only: 94% typ.)	
	200 VAC Input *1	94% typ. (Power supply section only: 96% typ.)	
Input conditions	Input voltage allowable range *3	85 to 264 VAC	
	Frequency *3	50/60 Hz (47 to 63Hz)	
	Input current	4.0A typ. (100 VAC input)	
		2.0A typ. (200 VAC input)	
	Power factor	0.9 min.	
	Leakage current	0.5 mA max. (100 VAC input)	
		1 mA max. (200 VAC input)	
Inrush current (for a cold start at 25°C)	7 A typ. (100 VAC input)		
	14 A typ. (200 VAC input)		
Output characteristics	Number of branches	4 (M12-L×2)	4 (M12-A×2, M-12L×1)
	Maximum cutoff output current (per branch)	M12-A: 3.8 A (Class 2 Output), M12-L: 10 A	
	Total output current	15A	
	Voltage variable range	24 to 28V (adjustable via HMI or IO-Link communication)	
	Ripple noise voltage (at rated input and outputs) *1	130 mVp-p max. (at 20 MHz of bandwidth)	
	Output leakage current	10 mA max.	
	Static input fluctuation	0.5% or less (at input 85 to 264 VAC, 100% load) *2	
	Load fluctuation	4.0% or less (at rated input, 0 to 100% Load) *2	
	Ambient temperature fluctuation	0.05%/°C max.	
	Startup time *5	2,000 ms max *1	
	Outputs hold time *5	45 ms typ. (at rated input and outputs) *1	
	Functions	Tripping functions	Abnormal voltage tripping
Abnormal current tripping *2			Setting range: M12-A: 0.5 to 3.8 A (in 0.1 A unit), M12-L: 0.5 to 10 A (in 0.1 A unit)
Abnormal total current tripping			The output is shut off when the total output current reaches 30 A for 1 s, 26 A for 2 s, 22.5 A for 5 s, 19.5 A for 10 s, or 18 A for 20 s.
Undervoltage detection functions		Undervoltage Detection	Setting range: 18.0 to 28.0 V (in 0.1 V unit)
Maintenance forecast monitor function		Years up to replacement time	Setting range: 0.0 to 5.0 yr (in 0.5 yr unit)
		Percentage up to replacement time	Setting range: 0.0 to 99.9% (in 0.1% unit)
		Total running time	Setting range: 0 to 132 kh (in 1kh unit)
Display functions		Output voltage display	Display range: 16.3 to 30.0 V Display accuracy: 2% rdg ±1 digit max.
		Output current display	Branch output current display range: 0.0 to 4.0 A (M12-A), 0.0 to 10.0 A (M12-L), Branch output peak current display range: 0.0 to 20.0 A Total output current display range: 0.0 to 40.0 A Display accuracy: M12-A 5% FS (4 A) ±1 digit max. M12-L 5% FS (10 A) ±1 digit max.
		Maintenance forecast monitor display (yr)	Display range: FUL (Full)/HLF (Half)/0.0 to 5.0 yrs
	Maintenance forecast monitor display (percentage)	Display rang: 0.0 to 99.9%	
	Total running time	Display range: 0 to 256 kh	

Model		S8NR-S36024-A0L2-IL3	S8NR-S36024-A2L1-IL3	
Functions	Startup sequence	Setting range: 0.0 to 99.9 seconds (0.1-second Unit) Default Branch output 1: 0.0 s Branch output 2: 0.4 s Branch output 3: 0.8 s Branch output 4: 1.2 s		
	Shutdown sequence	Setting range: 0.0 to 99.9 s (0.1 s Unit)		
	Series connection	Not supported.		
	Parallel connection	Not supported.		
	Output indicator	Provided (Color: green)		
	Indication monitor	Measurement/displayed details	For details, refer to <i>Parameter Table</i> on page 4-2.	
		Main display area	11-segment display (Color: white)	
Channel display area		Seven-segment display (Color: green)		
Unit display area		Provided (Color: yellow)		
Withstand voltage	Dielectric strength voltage	2k VAC for 1 min between (input terminals pins 1 and 3 collectively) and ( $\ominus$ , branch output terminals and IO-Link communications terminals collectively) Cutoff current: 20 mA)		
	Insulation resistance	100 M $\Omega$ min. at 500 VDC between ( $\oplus$ , branch output terminals and IO-Link communication terminals collectively) and (input terminals pins 1 and 3 collectively)		
Environment	Ambient operating temperature	-25 to 70°C (with no condensation or icing) *4		
	Storage temperature	-40 to 85°C		
	Ambient operating humidity	5 to 95%		
	Storage humidity	5 to 95%		
	Vibration resistance	10 to 55 Hz, 0.375 mm single amplitude, 2h each in X, and Z directions , maximum 4.5G		
	Shock resistance	150 m/s <sup>2</sup> times each in $\pm X$ , $\pm Y$ , $\pm Z$ directions.		
Reliability	MTBF	36,000 hours min.		
	Expected life	10 years		
Construction	Weight (main unit)	1,800g max		
	Cooling fan	blank		
	Protective structure(dustproof and waterproof) *8	IP67, UL Type1		
Compatible standards	Harmonic suppression	Conforms to EN61000-3-2		
	EMI	Conducted EMI	Compliant with EN 61204-3 Class B, EN 55011 Class B	
		Radiated EMI	Compliant with EN 61204-3 Class B, EN 55011 Class B *7	
	EMS	EN 61204-3 high severity levels		
	Safety standards	UL 508 (Listing, Class2 Output: Per UL 1310), Pol3 *6 CSA C22.2 No.107.1 (Class2 Output: Per CSA C22.2 No.223), Pol3 *6 EN/IEC 62477-1 (ES1 Output), OVCIII (<2000m), OVCI (2000m<and<3000m), Pol3 RCM (EN 61000-6-4) PELV(EN/IEC 60204-1)		

\*1. Rated input/output conditions: at rated input voltage, rated frequency, rated output voltage, rated total output current, and maximum cutoff output current.

\*2. 100% Load condition: at rated output voltage, rated total output current and maximum cutoff output current.

\*3. Although some inverters have an output frequency of 50/60 Hz, they may cause internal temperature to rise and result in damage, if they are connected as the power source for the S8NR-S. Do not use the output from an inverter as the power source for the S8NR-S.

\*4. For details, refer to *Derating Curve* on page 8.

\*5. For details, refer to *Inrush Current, Startup Time, Output Hold Time* on page 12.

\*6. Class2 Output is only for M12-A output.

\*7. When IO-Link communication is used, this product is classified as Class A.

\*8. With waterproof caps attached to unused terminals.

● S8NR-S60024-A□L□-IL3

Model		S8NR-S60024-A0L3-IL3	S8NR-S60024-A2L2-IL3	
Efficiency	200 VAC Input *1	94% typ. (Power supply section only: 95% typ.)		
	Input conditions			
Input conditions	Input voltage allowable range *3	170 to 264 VAC		
	Frequency *3	50/60 Hz (47 to 63Hz)		
	Input current	3.2A typ. (200 VAC input)		
	Power factor	0.9 min.		
	Leakage current	1 mA max. (200 VAC input)		
	Inrush current (for a cold start at 25°C)	14 A typ. (200 VAC input)		
Output characteristics	Number of branches	6 (M12-L×3)	6 (M12-A×2, M-12L×2)	
	Maximum cutoff output current (per branch)	M12-A: 3.8 A (Class 2 Output), M12-L: 10 A		
	Total output current	25A		
	Voltage variable range	24 to 28V (adjustable via HMI or IO-Link communication)		
	Ripple noise voltage (at rated input and outputs) *1	180 mVp-p max. (at 20 MHz of bandwidth)		
	Output leakage current	10 mA max.		
	Static input fluctuation	0.5% or less (at input 170 to 264 VAC, 100% load) *2		
	Load fluctuation	4.0% or less (at rated input, 0 to 100% Load) *2		
	Ambient temperature fluctuation	0.05%/°C max.		
	Startup time *5	2,000 ms max *1		
	Outputs hold time *5	20 ms typ. (at rated input and outputs) *1		
	Functions	Tripping functions	Abnormal voltage tripping	24.0 to 32.0V (in 0.1 V unit)
			Abnormal current tripping *2	Setting range: M12-A: 0.5 to 3.8 A (in 0.1 A unit), M12-L: 0.5 to 10 A (in 0.1 A unit)
			Abnormal total current tripping	The output is shut off when the total output current reaches 43.5 A for 2 s, 37.5 A for 5 s, 32.5 A for 10 s, or 30 A for 20 s
Undervoltage detection functions		Undervoltage Detection	Setting range: 18.0 to 28.0 V (in 0.1 V unit)	
		Maintenance forecast monitor function	Years up to replacement time	Setting range: 0.0 to 5.0 yr (in 0.5 yr unit)
Percentage up to replacement time			Setting range: 0.0 to 99.9% (in 0.1% unit)	
Total running time			Setting range: 0 to 132 kh (in 1kh unit)	
Display functions		Output voltage display	Display range: 16.3 to 30.0 V Display accuracy: 2% rdg ±1 digit max.	
		Output current display	Branch output current display range: 0.0 to 4.0 A (M12-A), 0.0 to 10.0 A (M12-L), Branch output peak current display range: 0.0 to 20.0 A Total output current display range: 0.0 to 40.0 A Display accuracy: M12-A 5% FS (4 A) ±1 digit max. M12-L 5% FS (10 A) ±1 digit max.	
		Maintenance forecast monitor display (yr)	Display range: FUL (Full)/HLF (Half)/0.0 to 5.0 yrs	
		Maintenance forecast monitor display (percentage)	Display range: 0.0 to 99.9%	
		Total running time	Display range: 0 to 256 kh	
Startup sequence		Setting range: 0.0 to 99.9 seconds (0.1-second Unit) Default Branch output 1: 0.0 s Branch output 2: 0.4 s Branch output 3: 0.8 s Branch output 4: 1.2 s Branch output 5: 1.6 s Branch output 6: 2.0 s		
Shutdown sequence		Setting range: 0.0 to 99.9 s (0.1 s Unit)		
Series connection		Not supported.		
Parallel connection		Not supported.		
Output indicator		Provided (Color: green)		
Indication monitor		Measurement/displayed details	For details, refer to <i>Parameter Table</i> on page 4-2.	
		Main display area	11-segment display (Color: white)	
		Channel display area	Seven-segment display (Color: green)	
	Unit display area	Provided (Color: yellow)		

Model		S8NR-S60024-A0L3-IL3	S8NR-S60024-A2L2-IL3
Withstand voltage	Dielectric strength voltage	2k VAC for 1 min between (input terminals pins 1 and 3 collectively) and (⊕, branch output terminals and IO-Link communications terminals collectively) Cutoff current: 20 mA)	
	Insulation resistance	100 MΩ min. at 500 VDC between (⊕, branch output terminals and IO-Link communication terminals collectively) and (input terminals pins 1 and 3 collectively)	
Environment	Ambient operating temperature	-25 to 70°C (with no condensation or icing) *4	
	Storage temperature	-40 to 85°C	
	Ambient operating humidity	5 to 95%	
	Storage humidity	5 to 95%	
	Vibration resistance	10 to 55 Hz, 0.375 mm single amplitude, 2h each in X, Y, and Z directions , maximum 4.5G	
	Shock resistance	150 m/s <sup>2</sup> times each in ±X, ±Y, ±Z directions.	
Reliability	MTBF	36,000 hours min.	
	Expected life	10 years	
Construction	Weight (main unit)	1,800g max	
	Cooling fan	blank	
	Protective structure(dustproof and waterproof) *8	IP67, UL Type1	
Compatible standards	Harmonic suppression	Conforms to EN61000-3-2	
	EMI	Conducted EMI	Compliant with EN 61204-3 Class B, EN 55011 Class B
		Radiated EMI	Compliant with EN 61204-3 Class B, EN 55011 Class B *7
	EMS	EN 61204-3 high severity levels	
Safety standards	UL 508 (Listing, Class2 Output: Per UL 1310), Pol3 *6 CSA C22.2 No. 107.1 (Class2 Output: Per CSA C22.2 No.223), Pol3 *6 EN/IEC 62477-1 (ES1 Output), OVCIII (<2000m), OVCII (2000m<and<3000m), Pol3 RCM (EN 61000-6-4) PELV(EN/IEC 60204-1)		

- \*1. Rated input/output conditions: at rated input voltage, rated frequency, rated output voltage, rated total output current, and maximum cutoff output current.
- \*2. 100% Load condition: at rated output voltage, rated total output current and maximum cutoff output current.
- \*3. Although some inverters have an output frequency of 50/60 Hz, they may cause internal temperature to rise and result in damage, if they are connected as the power source for the S8NR-S. Do not use the output from an inverter as the power source for the S8NR-S.
- \*4. For details, refer to *Derating Curve* on page 8.
- \*5. For details, refer to *Inrush Current, Startup Time, Output Hold Time* on page 12.
- \*6. Class2 Output is only for M12-A output.
- \*7. When IO-Link communication is used, this product is classified as Class A.
- \*8. With waterproof caps attached to unused terminals.

### ● IO-Link Specifications

Item	Description
IO-Link Specifications	Ver 1.1.4
Baud rate	COM3: 230.4 kbps (fixed)
Device profile	Common Profile, Locator
Minimum cycle time	COM3: 2.0 ms
Data length	PD size: 22byte OD size: 1byte (M-sequence type: TYPE_2_V)
Port class	ClassA

Please contact your OMRON sales representative regarding the IO-Link setup file (IODD file).

# 2-4 Basic Function Details

## 2-4-1 Voltage Monitoring and Protection Functions

### Abnormal Voltage Tripping (Protection levels that allow parameter setting changes: Levels 0)

The related indexes for this function are as follows.

- Index 112 Abnormal voltage tripping threshold

When the AC/DC-converted output voltage exceeds the abnormal voltage tripping threshold, all branch outputs are cut off simultaneously.

At this time, the eleven-segment display shows the error code A10, and an IO-Link communication event occurs.

It is not necessary for the user to set any parameters for this function.

Setting range	Default value	Operation	Eleven-segment display	IO-Link communication event	Conditions required to reset
24.0 to 32.0 VDC	32.0 V	Alternately displays error code A10 and the voltage.	Alternately displays error code A10 and the voltage.	0x181D Abnormal voltage trip	Voltage below set value -0.3 V and after 15 seconds or more elapsed since tripping

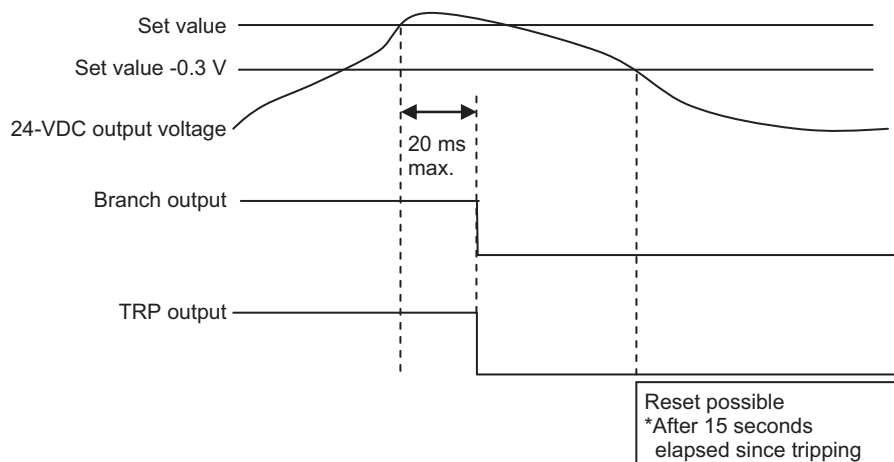

## Undervoltage Detection

(Protection levels that allow parameter setting changes: Levels 0)

The related indexes for this function are as follows.

- Index 114 Undervoltage detection threshold

An undervoltage detection threshold can be set between 18.0 and 28.0 VDC.

Setting range	Default value	Operation	Eleven-segment display	IO-Link communication event	Conditions required to reset
18.0 to 28.0 VDC	20.0 V	When the voltage is lower than the detection threshold continuously for 80 ms or more, the alarm is output within 100 ms.	Alternately displays error code A21 and the voltage.	0x1806 DC-Warning	Voltage above the detection threshold +0.3 V continuously for at least 500 ms.

### ● Operation

- When the output voltage falls to or below the detection threshold, the eleven-segment display shows the error code “A21” and the voltage value within 100 ms, and an IO-Link communication event occurs.
- The error display and Alarm Output can be reset when the voltage has been above the detection threshold +0.3 V for 500 ms longer.

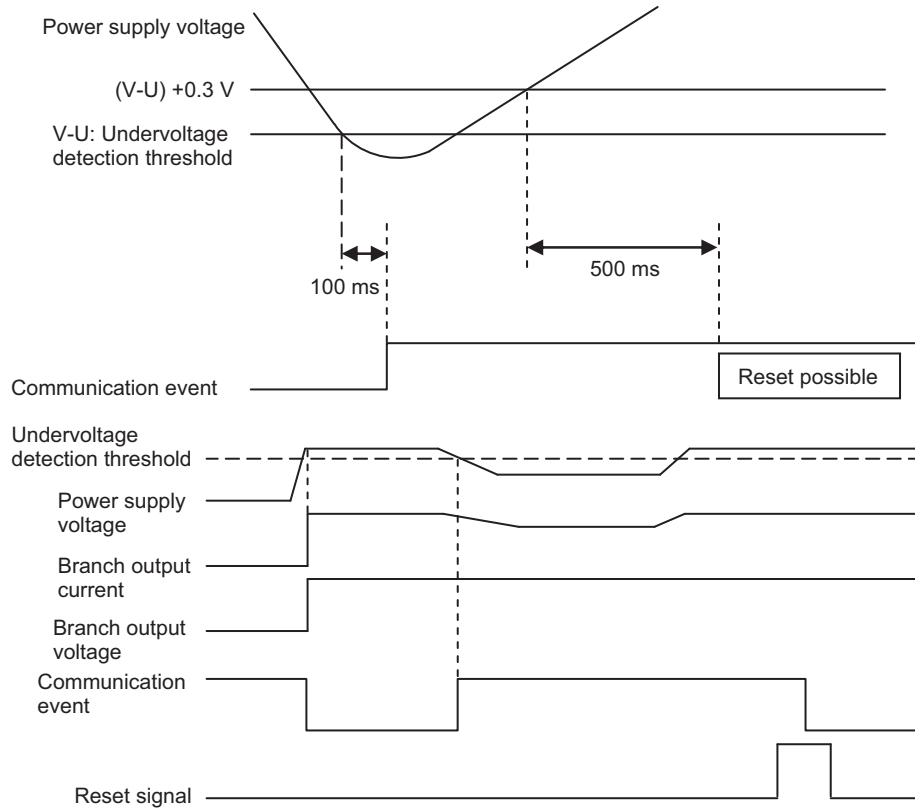

## 2-4-2 Over-current Protection Functions

### Abnormal Current Tripping Function

(Protection levels that allow parameter setting changes: Levels 0 and 1)

The related indexes for this function are as follows.

- Index 107 Current tripping type
- Index 108 Current tripping threshold

When an abnormal current is detected, the S8NR-S cuts off the branch outputs via power MOSFET. You can set the tripping current value for each branch output in the range of 0.5 to 3.8 A (in 0.1 A increments) for M12-A, and 0.5 to 10.0 A (in 0.1 A increments) for M12-L.

The parameter name is Abnormal current tripping threshold.

In addition, you can select one of the following three abnormal current detection methods for each branch output.

- Standard detection (cutoff within 100 ms)
- Instantaneous detection (cutoff within 20 ms)
- Long-time detection (cutoff within 1,000 ms)

The parameter name is Abnormal current tripping type.

Setting range	Default value	Tripping type	Operation	Abnormal indication and communication event	Conditions required to reset
<ul style="list-style-type: none"> <li>• M12-A: 0.5 to 3.8 A</li> <li>• M12-L: 0.5 to 10.0 A</li> </ul>	<ul style="list-style-type: none"> <li>• M12-A: 3.8 A</li> <li>• M12-L: 10.0 A</li> </ul>	Standard	When a current higher than the set value is detected, the branch output is cut off within 100 ms.	<ul style="list-style-type: none"> <li>• The eleven-segment display alternately displays the error code A11 and the current value.</li> <li>• Event codes 0x180B to 0x1810</li> </ul>	After 15 seconds or more elapsed since tripping
		Instantaneous	When a current higher than the set value is detected, the branch output is cut off within 20 ms.		
		Extended time	When a current higher than the set value is detected, the branch output is cut off within 1,000 ms.		

When an abnormal current is detected and a branch output is cut off, the eleven-segment display alternately displays the error code A11 and the current value at the time the abnormality occurs, and an IO-Link communication event occurs. The channel ON/OFF key of the branch output that was cut off will flash red.

To clear the error, eliminate the cause of the error. Recovery by the Reset Key or channel selection key is possible 15 seconds or more have elapsed since tripping.

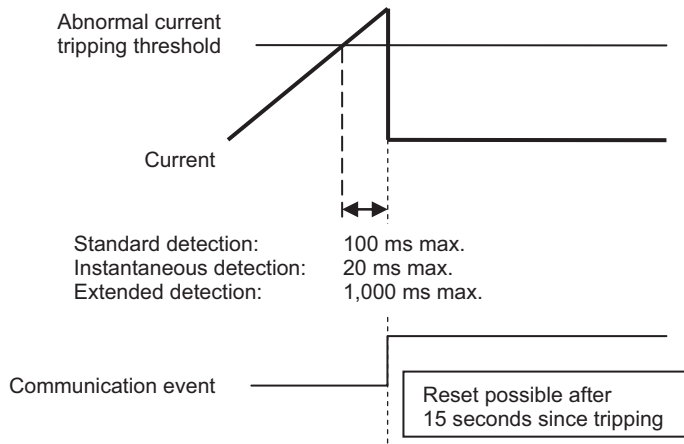

● **Current Tripping Characteristics**

- Standard Detection (M12-A)

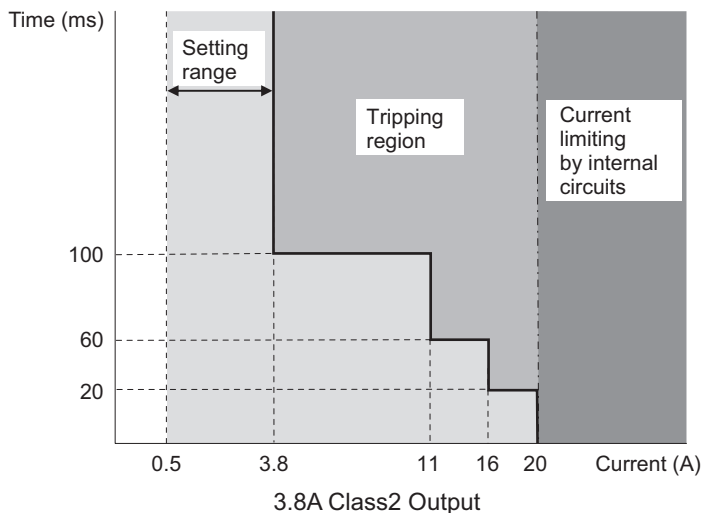

Tolerance of current tripping alarm threshold:  $\pm 0.3$  A.  
 When the tripping current (0.5 to 3.8 A) is detected, it is cut off within 100 ms.

- Extended Detection (M12-A)

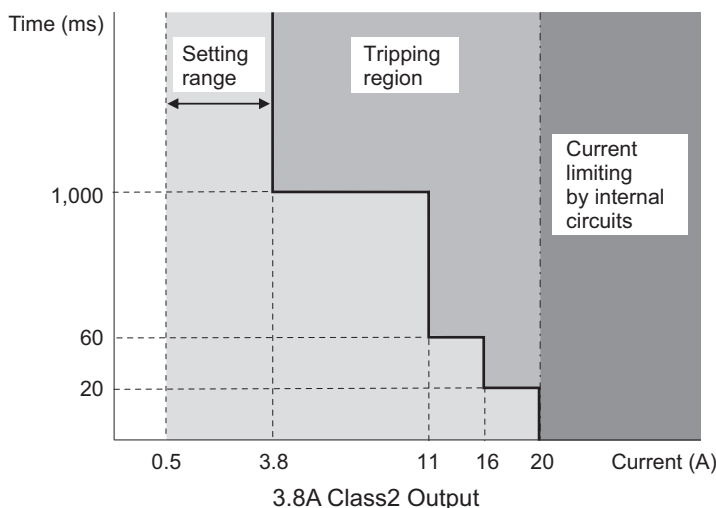

Tolerance of current tripping alarm threshold:  $\pm 0.3$  A.  
 When the tripping current (0.5 to 3.8 A) is detected, it is cut off within 20 ms.

- Instantaneous Detection (M12-A)

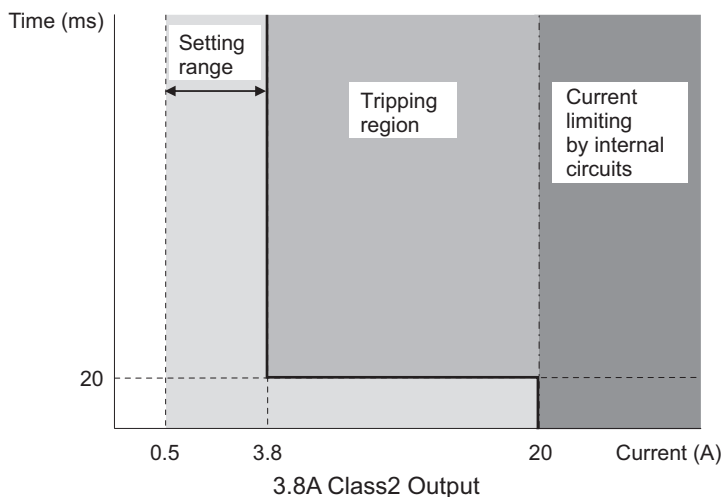

Tolerance of current tripping alarm threshold:  $\pm 0.3$  A.  
 When the tripping current (0.5 to 3.8 A) is detected, it is cut off within 1,000 ms.

- Standard Detection (M12-L)

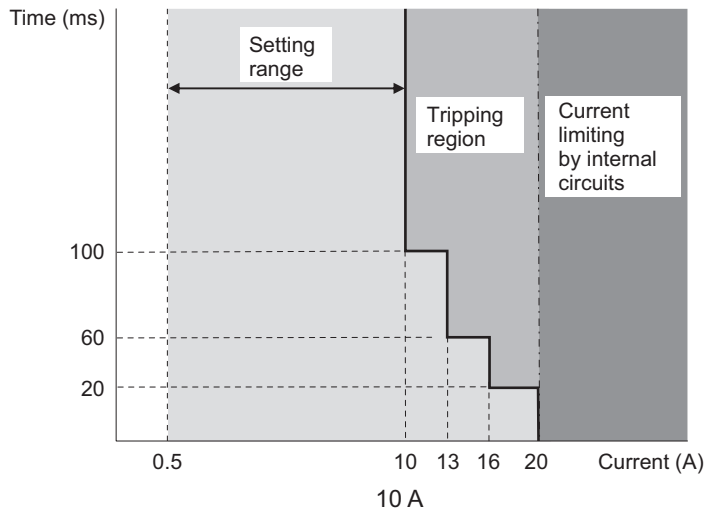

Tolerance of current tripping alarm threshold:  $\pm 0.3$  A.

When the tripping current (0.5 to 10 A) is detected, it is cut off within 100 ms.

- Extended Detection (M12-L)

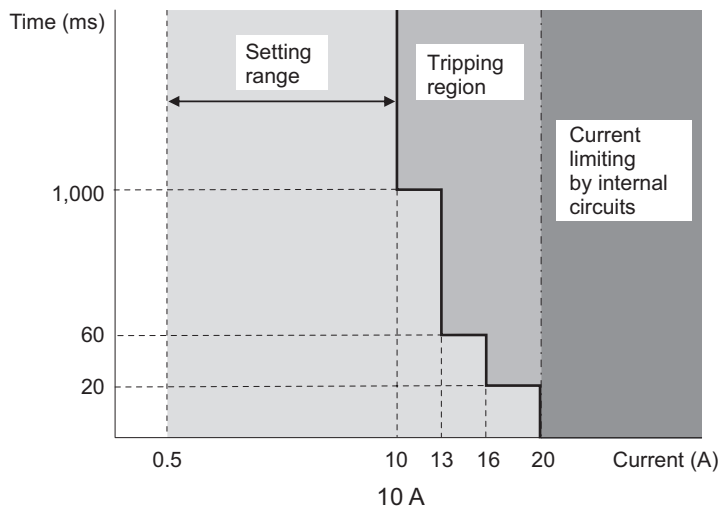

Tolerance of current tripping alarm threshold:  $\pm 0.3$  A.

When the tripping current (0.5 to 10 A) is detected, it is cut off within 20 ms.

- Instantaneous Detection (M12-L)

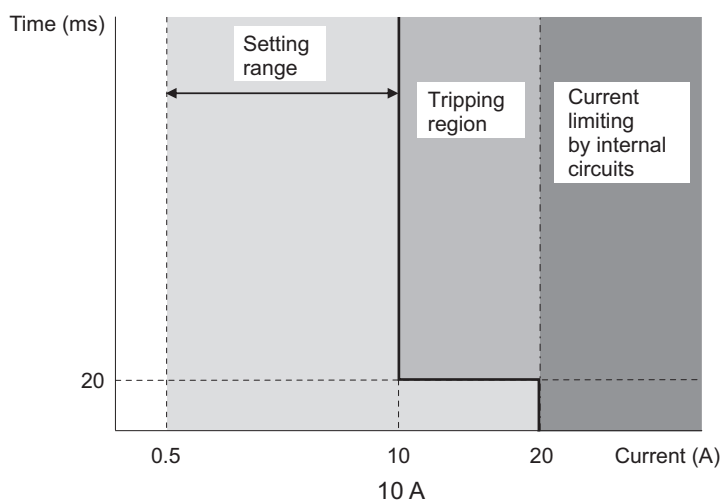

Tolerance of current tripping alarm threshold:  $\pm 0.3$  A.

When the tripping current (0.5 to 10 A) is detected, it is cut off within 1,000 ms.

**Note** The S8NR-S contains a current-restricting circuit that prevents a current above a specific value from flowing. The current is thus restricted during the time required to cut off the output.

## Abnormal Total Current Tripping Function

The S8NR-S monitors the total output current as well as the branch output currents. When the total output current exceeds the set value, all branch outputs will be cut off.

There are a number of conditions for the tripping current and time. If even one of these conditions is detected, the abnormal total current tripping function will be activated.

The following table outlines the tripping conditions.

Power-ON time (s)	Total current (A)		Operation	Abnormal indication and alarm output	Conditions required to reset
	360 W	600 W			
1 s min.	30	-	When the total current reaches these values, all branches will be cut off within 20 ms.	<ul style="list-style-type: none"> <li>The eleven-segment display flashes the error code A12.</li> <li>Event code 0x1807</li> </ul>	After 15 seconds or more elapsed since tripping
2 s min.	26	43.5			
5 s min.	22.5	37.5			
10 s min.	19.5	32.5			
20 s min.	18	30			

-: Not applicable

Note 1. If the total output current exceeds the maximum peak current value, internal operation will become unstable and the branch outputs may be cut off.

- Maintain the total current for normal operation after the load devices have started to within the rated ranges.

## Safety Functions

### ● Short-circuit Protection Fuse

If an error occurs that prevents the power MOSFET from cutting off a branch output, the short-circuit protection fuse will blow to protect the circuit.

Note If the fuse blows, that branch output cannot be used.

### 2-4-3 Output Voltage Adjustment Function

The related indexes for this function are as follows.

- Index 105 Output Voltage Setpoint

You can adjust the output voltage by key operation or by communication.

The adjustment range is 24.0 V to 28.0 V.

#### Setting method

(Protection levels that allow parameter setting changes: Levels 0 and 1)



##### ● Adjustment by key operation

**1** Press the mode switch key to enter Setting Mode. Setting Mode is active when **SET** is lit.

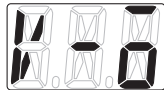
**2** Display output voltage.



**3** Press the enter key .

**4** Use the select up key  or select down key  to adjust to the desired voltage.

##### ● Adjustment by communication

Set the value by using IO-Link.

Index 105

For details, refer to *5-2 IO-Link Communication Index List* on page 5-3.

## 2-4-4 Remaining Output Current Function

The related index for this function is as follows.

- Index 90 Remaining output current

### Overview

The remaining output current function displays how much additional current can be supplied for each branch output.

By using this function, users can understand the remaining output current of each branch output and perform appropriate current management. This helps prevent overloads and abnormal currents and ensures safe operation.

### Calculation method

The remaining output current is calculated based on the following formulas, and the smaller calculated value is displayed as the remaining output current.

**Formula 1** **Abnormal current tripping threshold** - **Current value**

**Formula 2** **(Total capacity ÷ Current voltage value)** - **Total current value**

Using these calculations, the remaining output current for each branch output is determined.

Example

Assume that the S8NR-S is a **600 W** model with **an output voltage of 24 V**, and the current values of each branch output are as follows.

	Branch output 1	Branch output 2	Branch output 3	Branch output 4	Branch output 5	Branch output 6	Total current
Current value	3.0 A	0.5 A	8.0 A	9.5 A	2.5 A	0.5 A	24 A

Assume that the abnormal current tripping thresholds for Formula 1 are as follows.

Formula 1	Branch output 1	Branch output 2	Branch output 3	Branch output 4	Branch output 5	Branch output 6
Abnormal current tripping threshold	3.8 A	1.0 A	10.0 A	10.0 A	5.0 A	1.0 A

The parameters used in Formula 2 are as follows.

**Total capacity: 600 W**

**Total current value: 24 A**

Total current value: 24 A (Sum of current values: 3.0 A + 0.5 A + 8.0 A + 9.5 A + 2.5 A + 0.5 A = 24 A)

Applying these values to Formula 2:

$$(600 \text{ W} \div 24 \text{ V}) - 24 \text{ A} = 1.0 \text{ A}$$

	Branch out-put 1	Branch out-put 2	Branch out-put 3	Branch out-put 4	Branch out-put 5	Branch out-put 6
Current value	3.0 A	0.5 A	8.0 A	9.5 A	2.5 A	0.5 A
Formula 1 result	$3.8-3.0=0.8 \text{ A}$	$1.0-0.5=.5 \text{ A}$	$10.0-8.0=2.0 \text{ A}$	$10.0-9.5=0.5 \text{ A}$	$5.0-2.5=2.5 \text{ A}$	$1.0-0.5=0.5 \text{ A}$
Formula 2 result	1.0 A	1.0 A	<b>1.0 A</b>	1.0 A	<b>1.0 A</b>	1.0 A
Smaller of Formula 1 and Formula 2	<b>0.8 A</b>	<b>0.5 A</b>	<b>1.0 A</b>	<b>0.5 A</b>	<b>1.0 A</b>	0.5 A

As shown above, the smaller value of Formula 1 and Formula 2 is displayed as the remaining output current and can also be read via IO-Link communication.

By checking this remaining output current, for example, you can determine that an additional 1 A load can be connected to branch output 3.

### 2-4-5 Stress Level Function

The related index for this function is as follows.

- Index 66 Stress level

This function notifies how much of the total capacity is being used.

$(\text{Current voltage value} \times \text{Total current}) \div \text{Total capacity} \times 100 (\%)$

This value is not displayed and can be read only via IO-Link communication. This function indicates the capacity usage status of the power supply.

Example:

For a 600 W power supply with a current voltage value of 24.0 V and a total current of 20.0 A, the stress level is 80.0%.

Because the power supply can be used at 100% or higher, the stress level range is not limited and spans from 0% to 999.9%.

### 2-4-6 Standby Function

The related index for this function is as follows.

- Index 101 Standby

This function controls permission and inhibition of the 24 V output based on commands from communication.

You can set this function only via IO-Link.

In the standby state, the 24 V output stops, and all branch outputs turn OFF.

When standby is released, the outputs return to the connection state before standby.

During standby, "STB" flashes on the eleven-segment display.

The standby function operates independently of the Channel ON/OFF key and forcibly sets the above state.

### 2-4-7 Maintenance Forecast Monitor Function

The related indexes for this function are as follows.

- Index 67 Years until replacement
- Index 68 Percentage until replacement
- Index 116 Years threshold until replacement
- Index 117 Percentage threshold until replacement

This product has a built-in electrolytic capacitor. Electrolytic capacitors undergo degradation in characteristics, such as a decrease in capacitance, over time due to the evaporation of the internal electrolyte solution. This degradation begins at the time of manufacture as the impregnated electrolyte solution permeates the sealing rubber. Due to degradation of this electrolytic capacitor's characteristics, this product will become unable to perform sufficiently over time. The maintenance forecast monitor function calculates an estimated period until this product will no longer be able to perform sufficiently due to degradation of the electrolytic capacitor's characteristics. This feature can be used as a guideline for finding out when to replace the product main unit.

**Note** The maintenance forecast monitor function indicates an estimated period until the product will no longer be able to perform sufficiently due to degradation of the electrolytic capacitor. This function does not cover failures caused by other factors.

## Principle of Operation

The degradation rate of an electrolytic capacitor varies considerably with ambient temperature (generally following the doubling for every 10°C rule and the Arrhenius equation). The S8NR-S monitors the internal temperature of the product while powered ON, and calculates the degradation level of the electrolytic capacitor based on running time and internal temperature.

- Note**
1. Depending on the durability of the electronic components, we recommend replacing the electrolytic capacitors approximately 15 years after purchase, regardless of the maintenance forecast monitor number of years or percentage displayed.
  2. The replacement time varies depending on changes in operating conditions. Check the display periodically.
  3. In applications where the input power is frequently turned ON and OFF, the accuracy of the maintenance forecast monitor function may deteriorate.

## Years until replacement

**FULL** is indicated at the time of purchase (when initially powered on), and continues to be indicated for approximately one month. Afterward, the state of deterioration for the electrolytic capacitor is calculated based on the usage environment, **HLF** and is indicated when deterioration progresses. When the years until replacement reaches 5 years or less, it is indicated in 0.1 step increments within the range of 0.0 to 4.9. (Depending on the usage environment, the number of years may be indicated after **FULL** without **HLF** being indicated.)

**Note** The number of years until replacement may vary if there are frequent load variations or in locations where the ambient temperature fluctuates drastically.

## Percentage until replacement

With the number of years until replacement at the time of manufacture set as 100%, as deterioration of the electrolytic capacitor progresses through use, it decreases in 0.1% step increments.

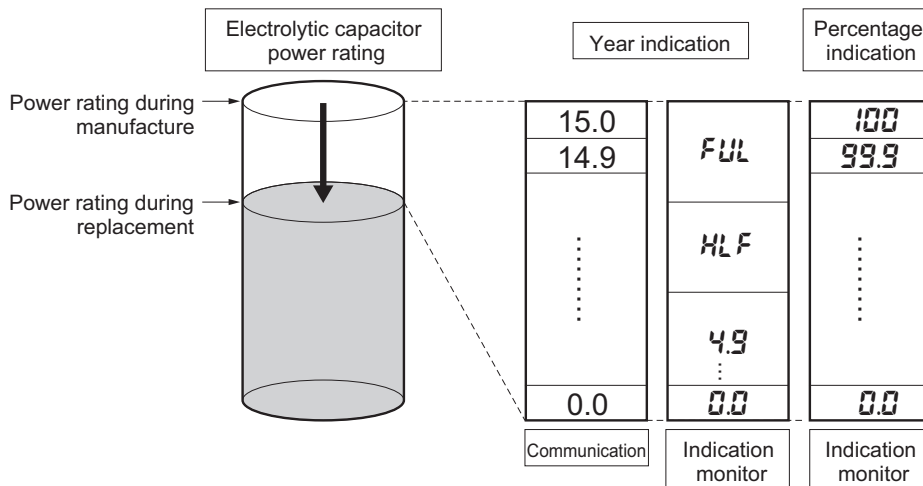

Relationship between electrolytic capacitor power rating and indicator

## Difference between Expected Life and Replacement Time

OMRON calculates the expected life based on the following conditions.

1. Rated input voltage
2. Load rate: 50%
3. Ambient temperature: +40°C
4. Standard mounting

Note As the values were calculated using an aluminum electrolytic condenser temperature rise test, they are not guaranteed. Use this data as a reference for maintenance and replacement time calculation.

The expected life span of the S8NR-S is 10 years minimum. Also, a replacement time calculation function is included among the functions of the S8NR-S.

The replacement time is the service life (the Power Supply's internal temperature is monitored at all times) of the internal electrolytic capacitor in actual operating conditions, and varies according to the customers operating conditions. 15 years is taken as the maximum period of the maintenance forecast.

### 2-4-8 Total Run Time

The related index for this function is as follows.

- Index 73 Total operating time

The accumulated value of the product's time powered on is measured as the total run time. Total run time increases in 1 (kh) steps.

#### Time Chart

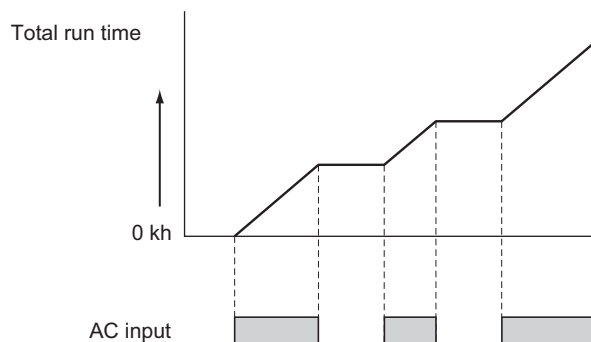

- Note 1. The total run time does not include the time that the Power Supply is OFF.
2. The total run time measures the total time that power is being supplied and is not related in any way to deterioration in the electrolytic capacitor built into the Power Supply or to the effects of the ambient temperature.

### 2-4-9 Pre-alarm Function

The related index for this function is as follows.

- Index 104 Total current pre-alarm level

This function notifies pre-alarm information\*1 when the current of each branch output or the total current exceeds the set value of the total current pre-alarm level.

Setting and notification are performed only via communication (IO-Link).

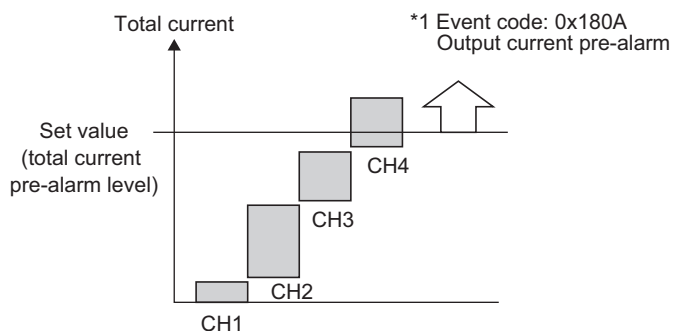

## 2-5 Startup Sequence Function

The inrush current may cause a voltage drop if all of the branch outputs are connected simultaneously and there is little spare capacity in the power supply or the loads connected to the branch outputs are capacitive loads. A significant voltage drop may cause an output to be cut off. In this case, a time delay can be applied between the connections of the branch outputs to minimize the voltage drop.

- Note 1. The time delay can be set between 0.0 and 99.9 s. (If the delay is set to 0.0 s, the startup sequence will not operate and the branch output will be connected immediately.)
2. The startup sequence is designed for the four branch outputs on one S8NR-S. It does not provide time synchronization between outputs on more than one S8NR-S.

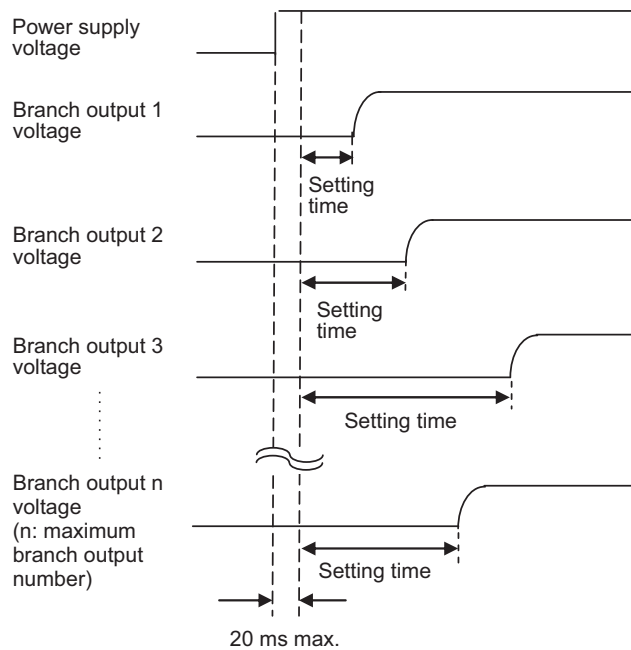

- During the startup sequence time-up waiting period, the Channel ON/OFF key of the branch output flashes green until connection starts.
- The initial settings of the startup sequence for each branch output are as follows.

Branch output number	1	2	3	4	5	6
Setting time (360 W)	0.0 s	0.4 s	0.8 s	1.2 s	-	-
Setting time (600 W)	0.0 s	0.4 s	0.8 s	1.2 s	1.6 s	2.0 s



### Additional Information

The startup sequence functions in the following processes:

- Connecting when power is turned ON
- Reconnecting during a reset operation
- External signal tripping input or operation by “software tripping trigger”

## 2-6 Shutdown Sequence Function

When the S8NR-S's input power supply is turned OFF, all of the branch outputs are turned OFF (disconnected) simultaneously. On the other hand, when the branch outputs are cut off by the external tripping input or communications, a time delay can be applied between the branch output disconnections.

- Note 1. The time delay can be set between 0.0 and 99.9 s. (If the delay is set to 0.0 s, the startup sequence will not operate and the branch output will be cut off immediately.)
2. The startup sequence is designed for the four branch outputs on one S8NR-S. It does not provide time synchronization between outputs on more than one S8NR-S.
  3. When operation is cut off due to an abnormal voltage, all of the branch outputs will be cut off simultaneously.
  4. The shutdown sequence function operates only for branch outputs for which the External tripping input cutoff for branch is set to Enable via communication. (Refer to Index 124 in *5-2 IO-Link Communication Index List* on page 5-3.)
  5. The initial value of the shutdown sequence for each branch output is set to 0.0 s.

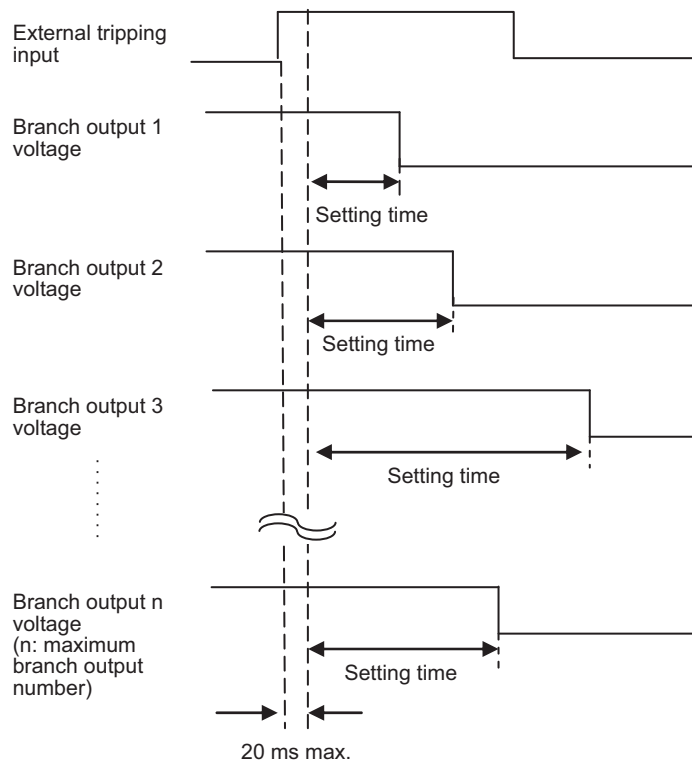

### Additional Information

The shutdown sequence functions in the following processes:

- Cutoff processing by external tripping input trip via communication
- Operation by parameter "software tripping input"

## 2-7 External Tripping Input Function via Communication

You can use the external tripping input via IO-Link communication to arbitrarily control cutoff of branch outputs and reconnection after cutoff by an external input. When you use this function, the following settings via IO-Link communication are required.

Item	Function	Settings
Index 124 External tripping input cutoff for branch	Enables the external tripping input function for each branch.	0: OFF (disabled) 1: ON (enabled)
Index 123 External tripping input function setting	Sets the external tripping input trigger signal type.	0: EGE (edge trigger) 1: LVL (level trigger)

### ●Tripping Trigger Type: Edge Trigger (EGE)

Tripping is performed at the rising edge of tripping input (state changes from OFF to ON).

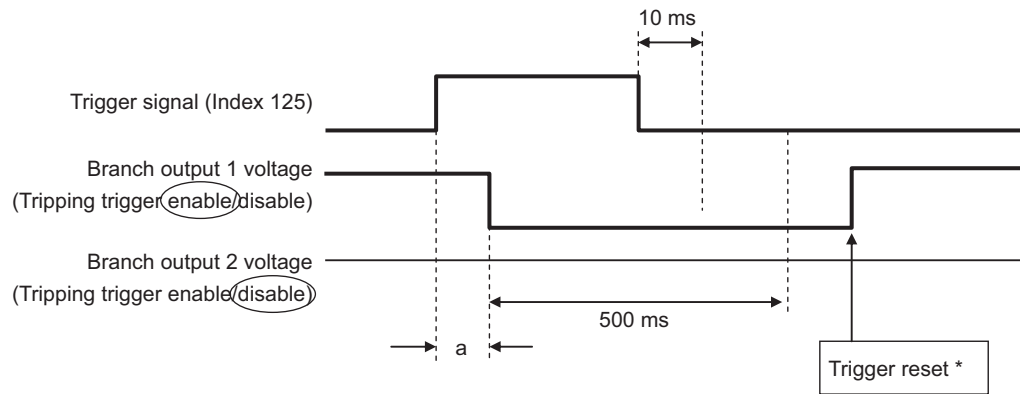

a: 20 ms + Shutdown sequence setting time

\*: Connected after startup sequence setting time has elapsed.

If the trigger signal stays OFF for 10 ms or more and the branch output is disconnected for 500 ms or more, the trigger reset can be accepted.

### ●Tripping Trigger Type: Level Trigger (LVL)

Tripping is performed at the rising edge of tripping input (state changes from OFF to ON), and the connection is made at the falling edge (state changes from ON to OFF).

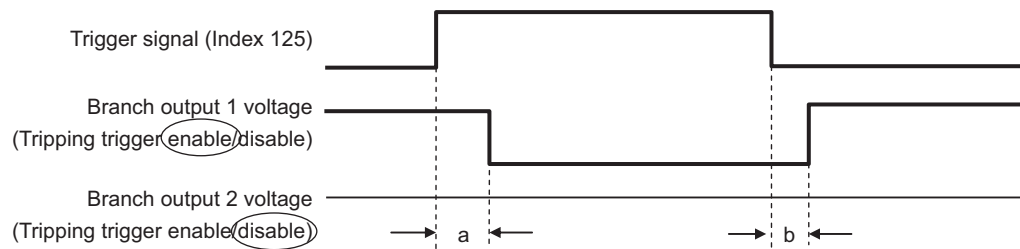

a: 20 ms + Shutdown sequence setting time

b: 20 ms + Startup sequence setting time

# 3

## Installation and Wiring

---

<b>3-1</b>	<b>Installing the S8NR-S</b> .....	<b>3-2</b>
<b>3-2</b>	<b>Installation</b> .....	<b>3-3</b>
<b>3-3</b>	<b>Smart Click Connection Method</b> .....	<b>3-6</b>
<b>3-4</b>	<b>Connector Wiring</b> .....	<b>3-7</b>

## 3-1 Installing the S8NR-S

---

To increase the S8NR-S system's reliability and take full advantage of the S8NR-S's functions, observe the following precautions when installing the S8NR-S.

### Installation Site

---

Avoid installing the product in the following locations.

To improve system reliability and ensure full performance, consider the following conditions when installing the product.

- Locations where the ambient temperature is outside the range of -25°C to 70°C
- Locations where the relative humidity exceeds 95%RH (with no condensation)
- Low dew-point environments
- Locations exposed to direct sunlight
- Locations where liquids, foreign matter, or corrosive gases may enter
- Locations subject to severe vibration or shock
- Locations near equipment that generates strong high-frequency noise or surges
- When using the product in the following locations, implement sufficient shielding measures.
- Locations subject to noise caused by static electricity or similar sources
- Locations where strong electric fields or magnetic fields are present
- Locations subject to possible exposure to radiation
- Locations close to power lines or motor power lines
- Locations where oil mist is present
- Locations exposed to spatter
- Locations exposed to high-pressure water
- Locations exposed to detergents or chemicals
- Locations where the temperature changes rapidly, such as near exhaust outlets
- Locations at altitudes of 3,000 m or higher

# 3-2 Installation

## Standard mounting

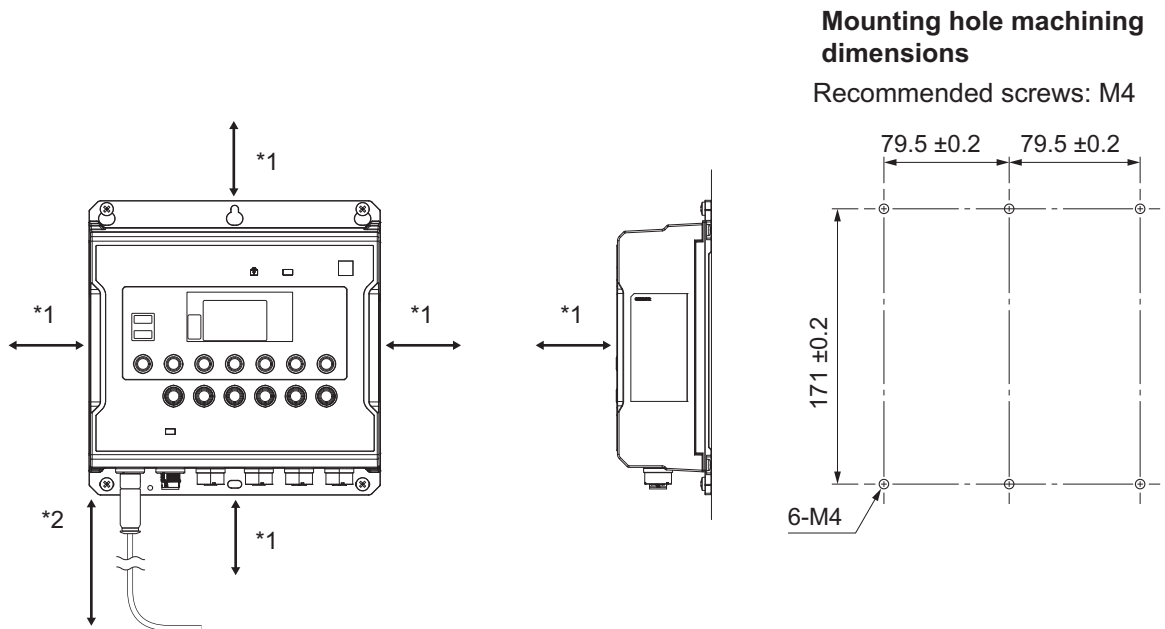

- \*1. Top, bottom, left, right, and front: 15 mm min.
- \*2. Secure sufficient space in consideration of cable mounting.  
Example: For the OMRON cable type XS5, provide approx. 150 mm.

## Mounting Method

When mounting the Product, ensure sufficient space for heat dissipation and wiring. Mounting is possible in the following six orientations.

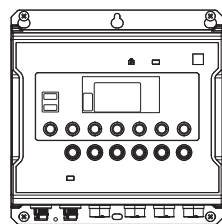

Standard mounting

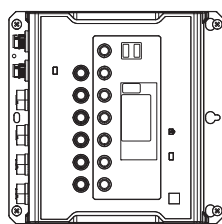

Horizontal mounting  
90° clockwise

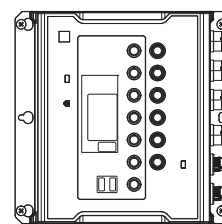

Horizontal mounting  
90° counterclockwise

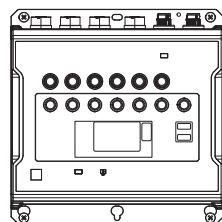

Inverted mounting

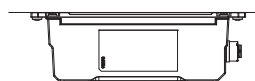

Downward mounting

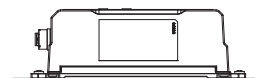

Upward mounting

## External Dimensions

● **S8NR-S36024**

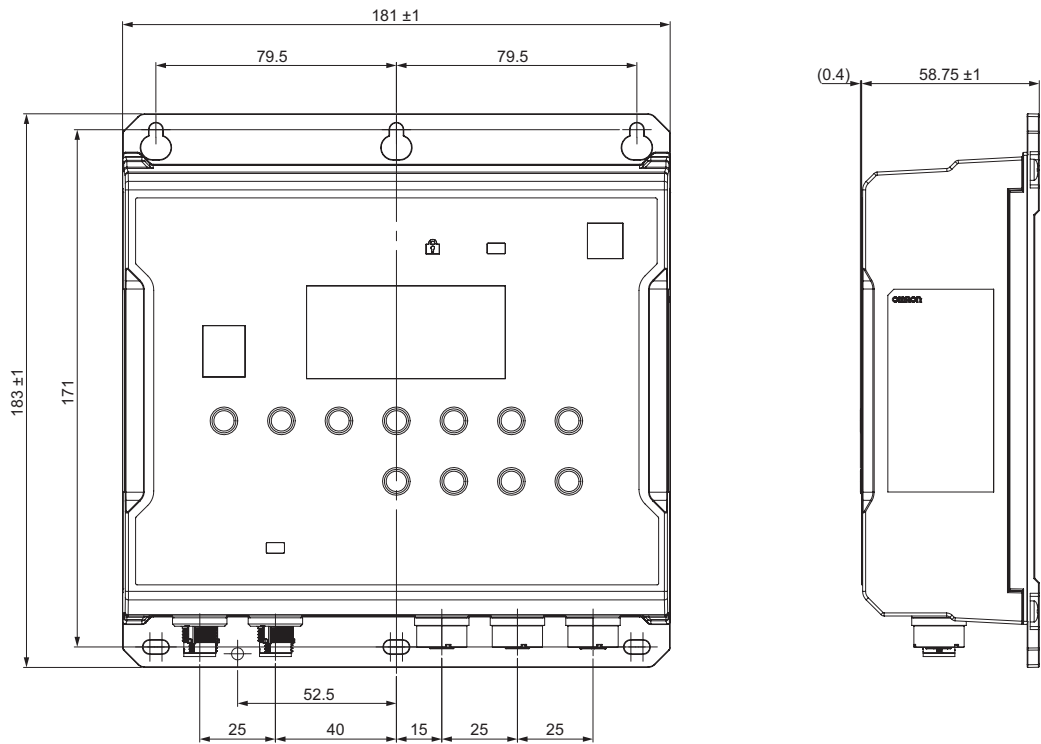

● **S8NR-S60024**

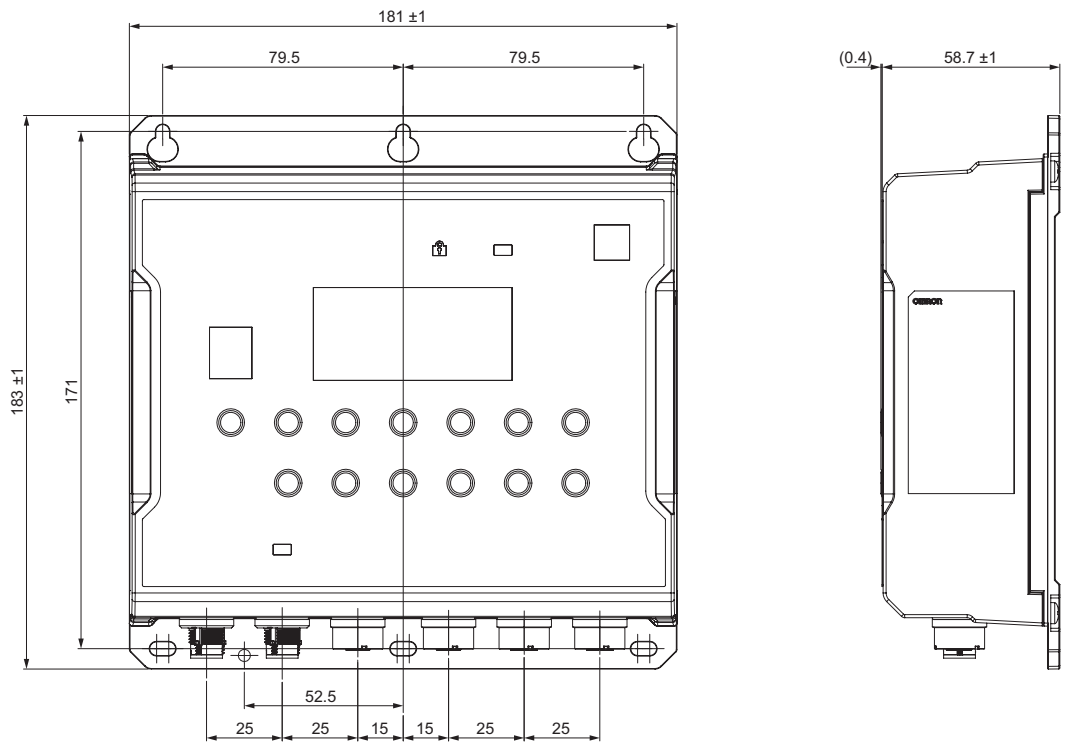

## DIN Track Installation (Optional Mounting Bracket)

When you mount the S8NR-S on a DIN Track, use the optional mounting bracket S82Y-NRS02DIN. Be sure to use the supplied screws. The recommended tightening torque for the mounting screws is 0.5 to 0.6 N·m.

When installing on a DIN Track, use the standard mounting orientation.

Mount the DIN Track with M4 screws in at least three places, with a maximum separation of 210 mm (6 holes) between screws. The tightening torque is 1.2 N·m (10.8 in·lb).

### • Recommended End Plate

PFP-M

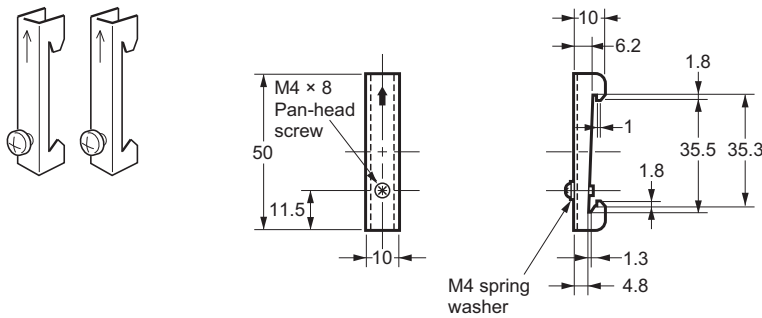

## 3-3 Smart Click Connection Method

- Smartclick installation method

- 1** Align the polarity key inside the connector and insert the projection on the plug fully into the groove on the socket.

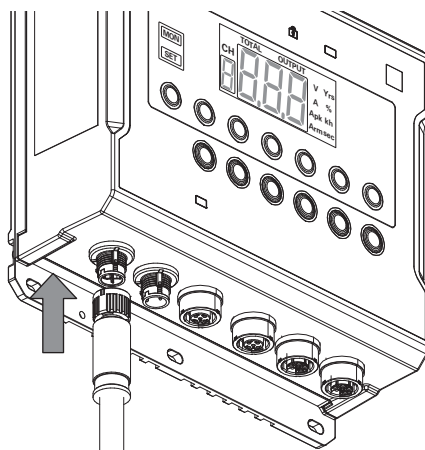

- 2** Rotate the cable retainer approximately 1/8 turn to the right. When you feel or hear a 'click,' the coupling is complete. You can also confirm by checking the coupling marks on the plug and socket.

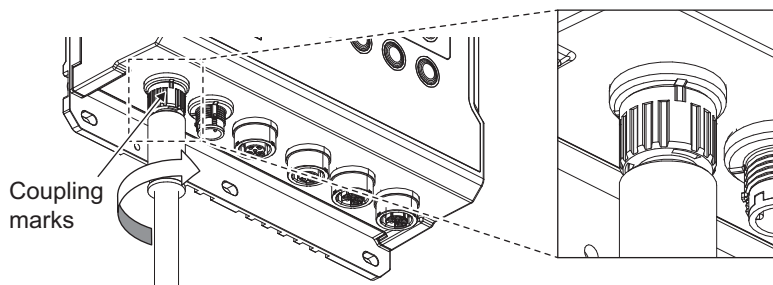

## 3-4 Connector Wiring

### Channel Assignment for Output Terminal Connectors

#### ● S8NR-S36024-A2L1-IL3

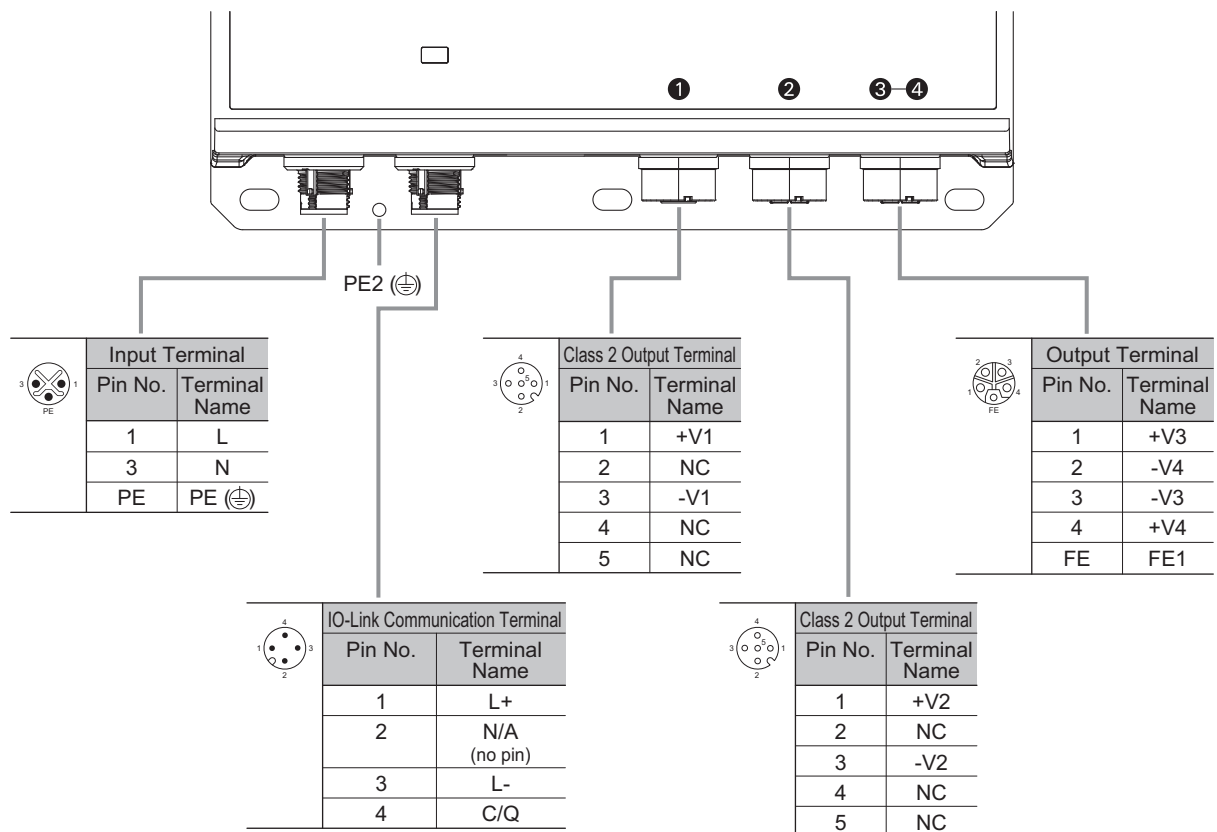

#### ● S8NR-S36024-A0L2-IL3

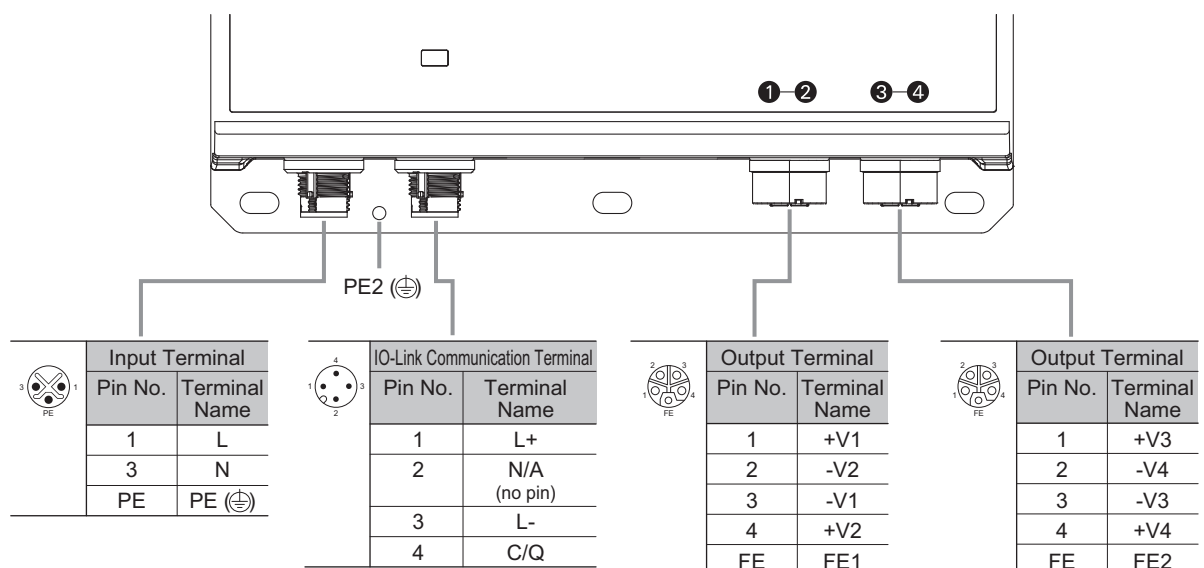

● S8NR-S60024-A2L2-IL3

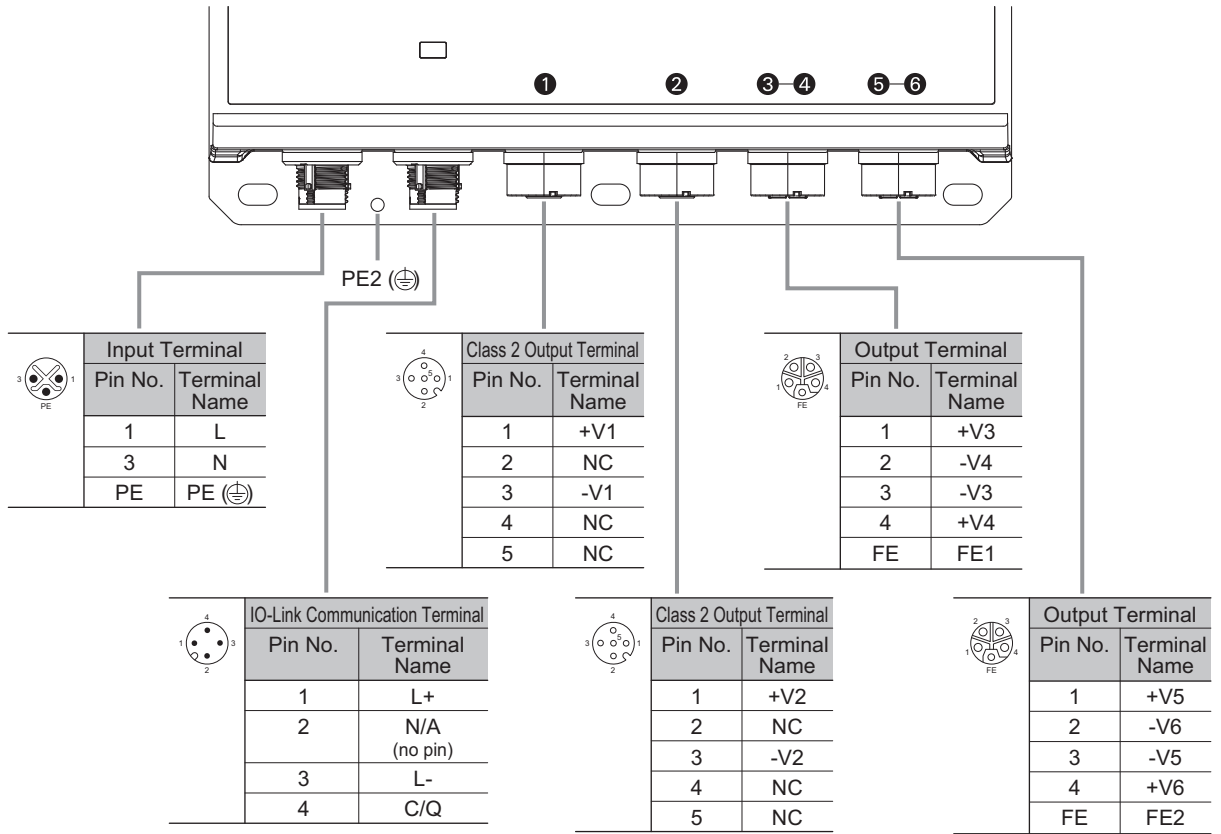

● S8NR-S60024-A0L3-IL3

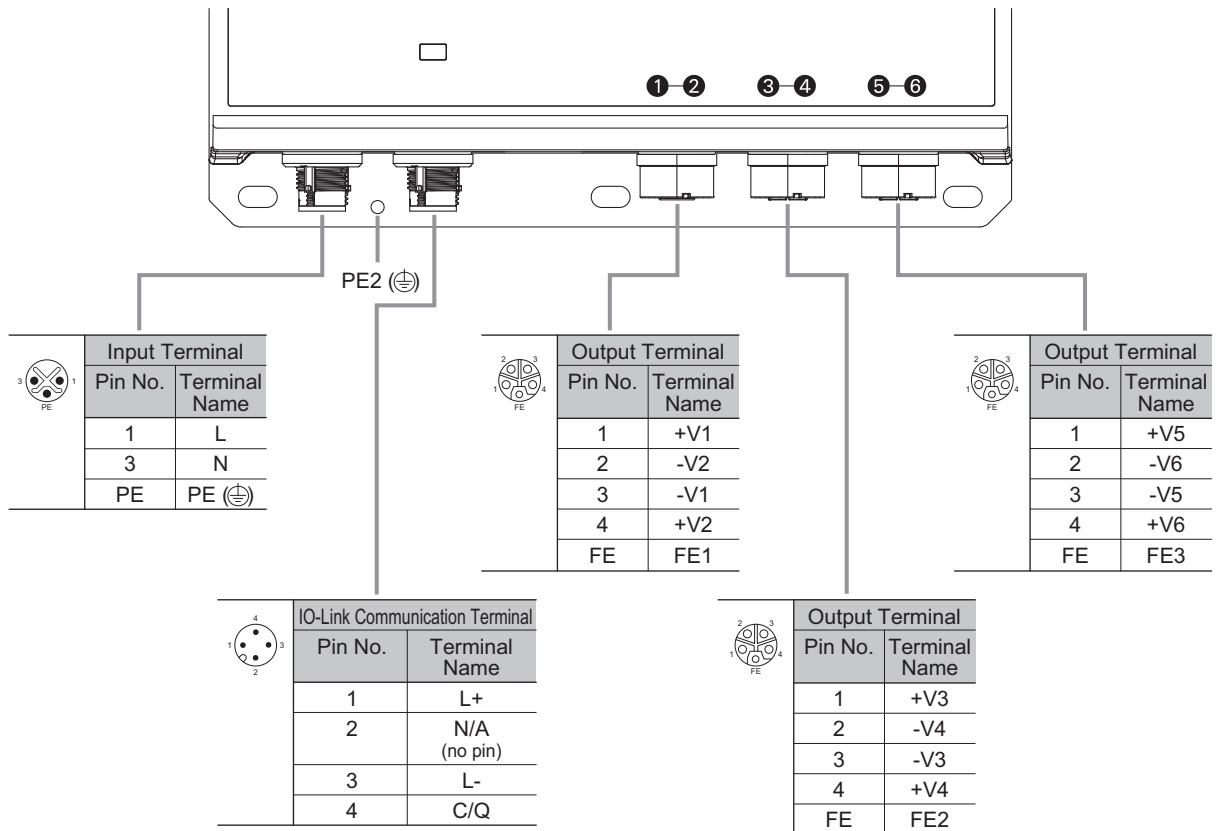

## Recommended cables

### ● Installation/Wiring

- Connect the ground completely. A protective earthing terminal stipulated in safety standards is used. Electric shock or malfunction may occur if the ground is not connected completely.
- Minor fire may possibly occur. Ensure that input and output terminals are wired correctly.
- To prevent wiring materials from smoking or ignition, use the wiring materials given in the following table.

#### Recommended Cables:

Terminal (Product side)	Connector name (Product side)	Recommended cables	
		Both-end connector	One-end connector
Input Terminal	M12-S (Plug)	XS5W-S321-□22-F	XS5F-S321-□22-F
Output Terminal	M12-A (Socket)	XS5W-D421-□81-F XS5W-D521-□G1-F	XS5F-D421-□80-F XS5F-D521-□G0-F
	M12-L (Socket)	XS5W-L521-□12-F	XS5H-L521-□12-F
IO-Link Communication Terminal	M12-A (Plug)	XS5W-D421-□81-F XS5W-D521-□G1-F	XS5H-D421-□80-F XS5H-D521-□G0-F

Use copper wires. Use stranded wire or solid wire (heat resistance: 75°C or higher).

- Do not insert or remove the Smart Click connector more than the durability limit of 50 cycles.



# 4

## Parameter Settings

The method for setting parameters for model S8NR-S is explained below.

---

<b>4-1</b>	<b>Parameter Table</b> .....	<b>4-2</b>
<b>4-2</b>	<b>Monitor Mode Parameters</b> .....	<b>4-4</b>
<b>4-3</b>	<b>Setting Mode Parameters</b> .....	<b>4-7</b>

## 4-1 Parameter Table

This is the parameter table for the S8NR-S. The Monitor Mode and Setting Mode each have their own parameters. Switch the operating mode and display content by using the mode switch key. For details, refer to *1-2 S8NR-S Operating Modes* on page 1-8.

### ● Monitor Mode

Monitor Mode parameters only display measured values. No changes are made to settings.

Parameter name (display order)	(1) Branch output indicators	(2) Eleven-segment display	(3) Unit	Display range	Page reference for details
Output voltage	Not lit.	Value	V	16.3 to 32.0	Page 4-4
Output current	1 to 4 (6)	Value	A, OUTPUT	0.0 to 20.0	Page 4-4
Total current	Not lit.	Value	A, TOTAL	0.0 to 60.0	Page 4-4
Peak current	1 to 4 (6)	Value	Apk	0.0 to 20.0	Page 4-5
Remaining output current	1 to 4 (6)	Value	Arm	0.0 to 10.0	Page 4-5
Years up to replacement time	Not lit.	Value	Yrs	0.0 to 4.9	Page 4-5
Percentage up to replacement time	Not lit.	Value	%	0.0 to 99.9	Page 4-6
Total running time	Not lit.	Value	kh	0 to 132	Page 4-6

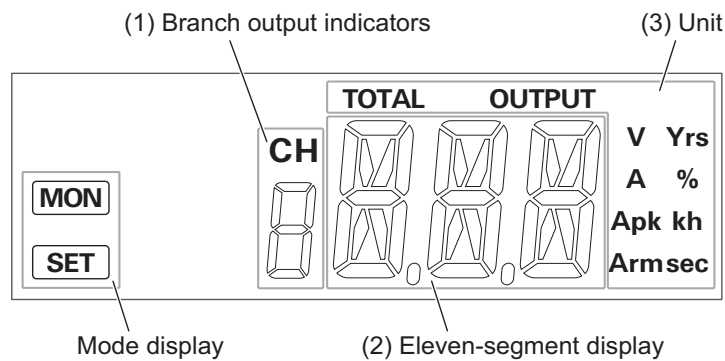

## ● Setting Mode

The parameters in the Setting Mode can be used to set alarm values and operations.

(Note, however, that settings cannot be viewed or changed depending on the protection level setting.)

For details, refer to *Protection level* on page 4-12 in 4-3 Setting Mode Parameters.

Parameter name (display order)	(1) Branch output indicators	(2) Eleven- segment display	(3) Unit	Setting range	Default value	Page reference for details
Output voltage setpoint	Not lit.	V-0	V	24.0 to 28.0	24.1	Page 4-7
Abnormal current tripping threshold	M12-A: 1 to 2	E-V	A	0.5 to 3.8	3.8	Page 4-8
	M12-L: 1 to 4 (6)			0.5 to 10.0	10.0	
Abnormal current tripping type	1 to 4 (6)	E-E	-	USU LNS LND	USU	Page 4-8
Abnormal voltage tripping threshold	Not lit.	V-V	V	24.0 to 32.0	32.0	Page 4-8
Undervoltage detection threshold	Not lit.	V-U	V	18.0 to 28.0	20.0	Page 4-9
Years threshold until replacement	Not lit.	LFE	Yrs	0.0 to 5.0	0.5	Page 4-9
Percentage threshold until replacement	Not lit.	LFP	%	0.0 to 99.9	0	Page 4-9
Running time alarm threshold	Not lit.	E-M	kh	0 to 132	132	Page 4-9
Startup sequence	1 to 4 (6)	UPS	Sec	0.0 to 99.9	*1	Page 4-10
Shutdown sequence	1 to 4 (6)	dWS	Sec	0.0 to 99.9	0	Page 4-10
Reset function setting	Not lit.	RSE	-	ALL KEY	ALL	Page 4-11
Protection level	Not lit.	PRE	-	LV.0 LV.1 LV.2	LV.1	Page 4-12
Channel ON/OFF key enable/disable	Not lit.	EHK	-	ON OFF	ON	Page 4-13
Initialize defaults	Not lit.	LEN	-	NO YES	NO	Page 4-13

\*1. The startup sequence is as follows.

Branch output number	1	2	3	4	5	6
Setting time (360 W)	0.0 s	0.4 s	0.8 s	1.2 s	-	-
Setting time (600 W)	0.0 s	0.4 s	0.8 s	1.2 s	1.6 s	2.0 s

## 4-2 Monitor Mode Parameters

This section describes the parameters in the Monitor Mode.

Display transition between parameters is performed by the Selection Down/Up Keys.

To switch the branch No. for branch output-related parameters, use the Channel Down/Up Keys.

The display state is held when the Monitor Mode is temporarily exited using the mode switch key.

When the display transitions to the Monitor Mode again, the subsequent display state is the top display.

### Output voltage

Common parameter

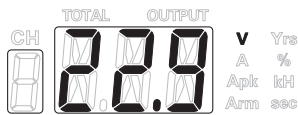

Displays the current output voltage value.

Display range	Unit
16.3 to 32.0	V

### Output current

Branch output parameter

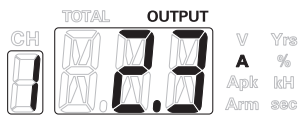

\* Branch output available

Displays the output current value of the current channel.

Pressing the Channel Down/Up Keys switches the display to another channel.

Display range	Unit
0.0 to 20.0	A

### Total current

Common parameter

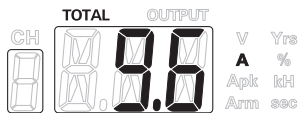

Displays the current total current value of all the branch outputs.

Display range	Unit
0.0 to 60.0	A

## Peak current

Branch output parameter

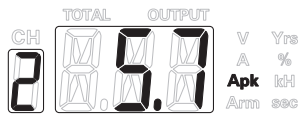

\* Branch output available

Displays the peak current value of the current channel.

Pressing the Channel Down/Up Keys switches the display to another channel.

Display range	Unit
0.0 to 20.0	Apk

- The peak current output can be cleared by following the procedure below.

- 1 Press the Enter Key.
- 2 From NO display  select either of using the Selection Down/Up Keys.

YES: Clear currently selected branch output

ALL: Clear all branch outputs

Pressing the ESC/RST Key returns to the previous screen without clearing branch outputs.

- 3 Press the Enter Key.



## Remaining output current

Branch output parameter

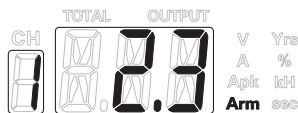

\* Branch output available

Displays the remaining output current of the currently selected channel.

It shows how much additional current can be supplied for each branch output.

Display range	Unit
0.0 to 10.0	Arm

## Years up to replacement time

Common parameter

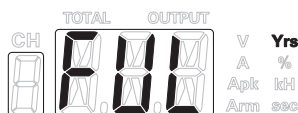

Displays the remaining number of years up to the replacement time by forecasting the replacement time of the S8NR-S.

Alarm judgment is performed based on this value.

For details, refer to 2-4-7 Maintenance Forecast Monitor Function on page 2-25.

Display range	Unit
0.0 to 4.9, HLF, FUL	Yrs

## Percentage up to replacement time

Common parameter

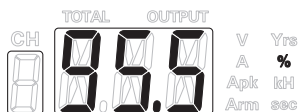

Displays the remaining percentage up to the replacement time by forecasting the replacement time of the S8NR-S.

Alarm judgment is performed based on this value.

For details, refer to *2-4-7 Maintenance Forecast Monitor Function* on page 2-25.

Display range	Unit
0.0 to 99.9	%

## Total running time

Common parameter

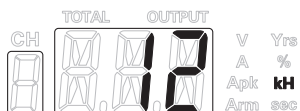

Displays the running time of the S8NR-S.

Alarm judgment is performed based on this value.

Example)

When the Eleven-segment display indicates “12”



This indicates a running time of 12,000 hours.

Display range	Unit
0 to 256	kh

## 4-3 Setting Mode Parameters

This section describes the parameters in the Setting Mode.

Parameter settings in the Setting Mode are made using the following 6 keys.

-  Selection Down Key
-  Channel Down Key
-  Enter Key
-  Selection Up Key
-  Channel Up Key
-  ESC/RST Key

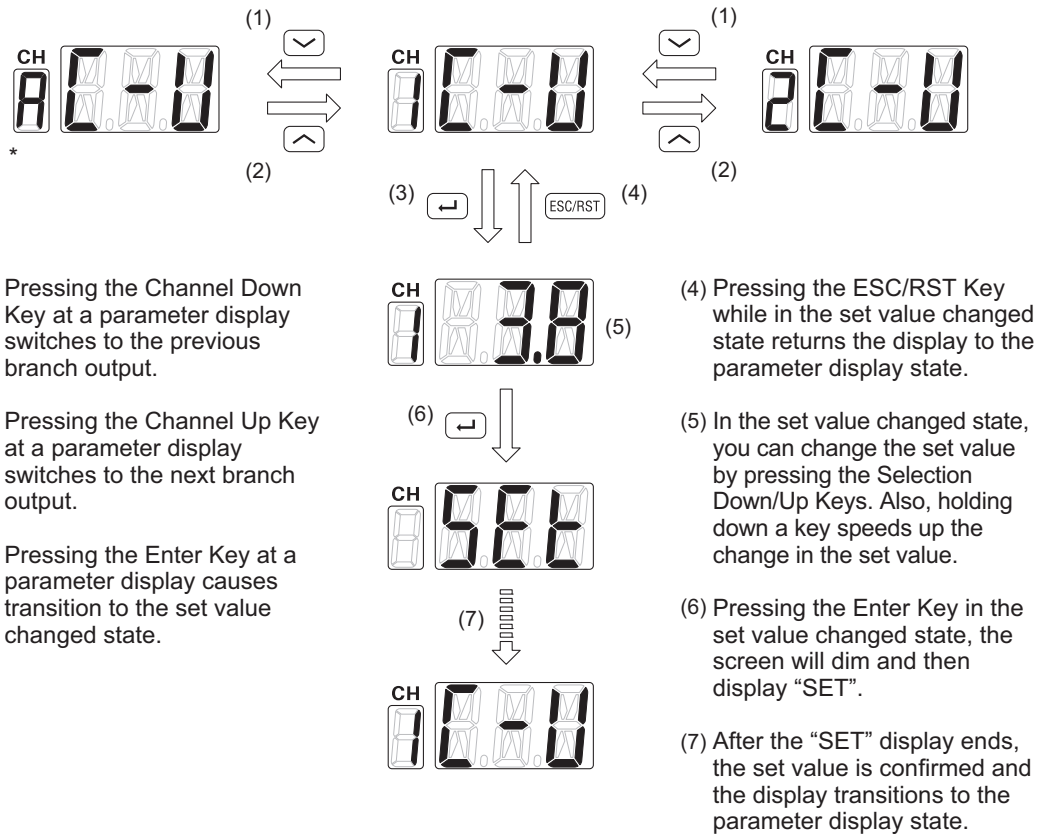

\* The "A" on the branch output indicators stands for "ALL." In this case, you can set the parameters for all channels together to the same value.

### Output Voltage Setpoint

Common parameter



Sets the output voltage.

Use this setting to adjust the output voltage.

Display range	Unit	Default value
24.0 to 28.0	V	24.1

## Abnormal current tripping threshold

Branch output parameter

(Protection levels that allow parameter setting changes: Levels 0 and 1)

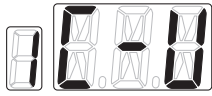

\* Branch output available

Set the abnormal current trip threshold of each branch output. If the current value at the branch output exceeds this set value, the circuit will be tripped.

Display range	Unit	Default value
M12-A: 0.5 to 3.8	A	3.8
M12-L: 0.5 to 10.0		10.0

## Abnormal current tripping type

Branch output parameter

(Protection levels that allow parameter setting changes: Levels 0 and 1)



\* Branch output available

Standard/Instantaneous/Extended time can be selected as the threshold time of abnormal current tripping for each branch output.

Standard (tripping within 100 ms)

Instantaneous (tripping within 20 ms)

Extended time (tripping within 1,000 ms)

Display range	Unit	Default value
USU : Standard INS : Instantaneous EXT : Extended time	-	USU

## Abnormal voltage tripping threshold

Common parameter

(Protection level that allows parameter setting changes: Level 0)

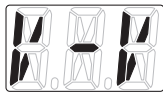

Sets the abnormal voltage tripping threshold for the output voltage.

If the output voltage exceeds this set value, the circuit will be tripped.

Display range	Unit	Default value
24.0 to 32.0	V	32.0

**Undervoltage detection threshold**

Common parameter

(Protection level that allows parameter setting changes: Level 0)

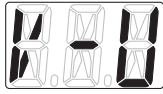

Sets the undervoltage alarm threshold for the output voltage.  
The circuit will not be tripped.

Display range	Unit	Default value
18.0 to 28.0	V	20.0

**Years threshold until replacement**

Common parameter

(Protection level that allows parameter setting changes: Level 0)

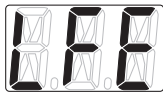

Set the number of years until replacement.

Display range	Unit	Default value
0.0 to 5.0	Yrs	0.5 years

**Percentage threshold until replacement**

Common parameter

(Protection level that allows parameter setting changes: Level 0)



Sets the maintenance forecast percentage threshold.

Display range	Unit	Default value
0.0 to 99.9	%	0.0

**Running time alarm threshold**

Common parameter

(Protection level that allows parameter setting changes: Level 0)

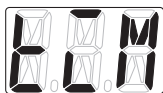

Sets the running time alarm threshold.

Example)

When the set value is "12"

An alarm will be output at a running time of 12,000 hours or more.

Display range	Unit	Default value
0 to 132	kh	132

## Startup sequence

Branch output parameter

(Protection level that allows parameter setting changes: Level 0)



\* Branch output available

When the startup sequence is set, a time delay can be provided to connections to each branch output at power ON. This function can reduce inrush current at power ON.

Display range	Unit	Default value
0.0 to 99.9	Sec	See the table below

The default values are as follows:

Branch output number	1	2	3	4	5	6
Setting time (360 W)	0.0 s	0.4 s	0.8 s	1.2 s	-	-
Setting time (600 W)	0.0 s	0.4 s	0.8 s	1.2 s	1.6 s	2.0 s

## Shutdown sequence

Branch output parameter

(Protection level that allows parameter setting changes: Level 0)

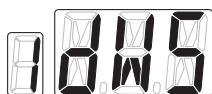

\* Branch output available

When using the external tripping input (TRG) to trip branch outputs, tripping can be performed with a time delay provided for each branch output.

Setting range	Unit	Default value
0.0 to 99.9	Sec	0.0

## Reset function setting

Common parameter

(Protection level that allows parameter setting changes: Level 0)

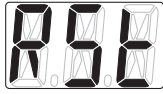

Sets the method for resetting the abnormal state after an abnormality occurs and its cause has been eliminated.

The default is "ALL." In this case, cycling the power supply will clear the abnormal state information and restart the product. \*1

If "KEY" is set, the abnormal state information will not be cleared even after cycling the power supply. Use this feature to leave a record of the abnormality.

\*1. If the cause of the abnormality has not been eliminated, the abnormality will be judged each time it occurs, and it may recur.

This parameter setting does not affect the reset operation performed by holding down the RST Key for 3 seconds.

Setting range	Unit	Default value
KEY: RST Key only enabled ALL: RST Key and power cycle	-	ALL

## Protection level

Common parameter

(Protection levels that allow parameter setting changes: Levels 0, 1, and 2)



3 levels of restriction can be applied to parameter read/setting operations.

This prevents parameter changes or loss due to inadvertent operation.

At shipment from the factory, the protection level is set to “1.”

Setting range	Unit	Default value
lv.0: All parameters can be read or changed. lv.1: Read/change of only operation settings related to voltage and current is permitted. lv.2: Parameter reading is restricted and all change operations are prohibited.	-	Lv1

The following table shows whether or not parameters can be set for each protection level.

The meaning of the symbols is as follows:

✓✓: Set value is changeable.

✓: Cannot be set. Set value can be displayed.

—: Cannot be set. Not even displayed.

Parameter name (display order)	(3) Unit		
	Level 2	Level 1	Level 0
Output voltage setpoint	✓	✓✓	✓✓
Abnormal current tripping threshold	✓	✓✓	✓✓
Abnormal current tripping type	—	✓✓	✓✓
Abnormal voltage tripping threshold	—	—	✓✓
Undervoltage detection threshold	—	—	✓✓
Years threshold until replacement	—	—	✓✓
Percentage threshold until replacement	—	—	✓✓
Running time alarm threshold	—	—	✓✓
Startup sequence	—	—	✓✓
Shutdown sequence	—	—	✓✓
Reset function setting	—	—	✓✓
Protection level	✓✓	✓✓	✓✓
Channel ON/OFF key enable/disable	✓✓	✓✓	✓✓
Initialize defaults	—	—	✓✓



In IO-Link communication, you can select Protection Level 3 in addition to Protection Levels 0 to 2. When Protection Level 3 is set, setting changes from the HMI and CH key operations are disabled, and parameters in Setting Mode are hidden. However, parameter display in Monitor Mode is available. In addition, you can use the key lock function. When the key lock is enabled, the display is fixed to the currently displayed parameter.

\* Key lock setting method:

Press and hold the Mode Switch Key and the Channel Down Key simultaneously for 3 seconds.

**Channel ON/OFF key enable/disable**

Common parameter

(Protection levels that allow parameter setting changes: Levels 0, 1, and 2)

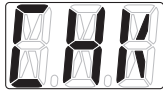

Sets whether to enable (ON) or disable (OFF) the channel ON/OFF key in the Monitor Mode.

Setting range	Unit	Default value
OFF: Disabled ON: Enabled	-	ON

**Initialize defaults**

Common parameter

(Protection level that allows parameter setting changes: Level 0)



This is used to return all settings to their default states.

Setting range	Unit	Default value
NO: Not initialized. YES: Initialization is executed.	-	NO



# 5

## IO-Link Communication

---

---

5-1 IO-Link Indicator . . . . .	5-2
5-2 IO-Link Communication Index List . . . . .	5-3

## 5-1 IO-Link Indicator

---

The LED indications are prioritized in the order shown in this table, from top to bottom. If multiple states occur at the same time, the indication listed higher in the table is displayed.

Indicator	Status	Description
Green flashing (fast)	Locator active	Two flashes followed by OFF repeat at a 1-second cycle for 10 minutes. This function allows you to visually identify this product among multiple devices at the installation site. For start and stop commands, refer to Index 2 (System Command) in <i>IO-Link Communication Index List</i> on page 5-3.
Red ON	Internal error	An internal failure may have occurred in the product. Restart the product. If the error occurs again, replace the product.
Green flashing	Communication established	IO-Link communication in progress.
OFF	Communication not established	No IO-Link communication.

## 5-2 IO-Link Communication Index List

The IO-Link communication index list is shown below.

### Service data

Index	Sub-Index	Name	Back up target	Format	Access	Length	Default value	Range	Remark
0	0	Direct Parameter Page 1	—	Record	R/W	16 byte	—	—	
2	0	System-Command	—	UInteger	W	1 byte	—	0x01: Param Upload Start 0x02: Param Upload End 0x03: Param Download Start 0x04: Param Download End 0x05: Param Download Store 0x06: Param Download Break 0x81: Application Reset 0x82: Restore Factory Settings 0x83: Back-to-Box 0x7E: Locator Start 0x7F: Locator Stop 0xA0: Alarm reset 0xA1: Clear peak output current ALL 0xA2: Clear peak output current CH1 0xA3: Clear peak output current CH2 0xA4: Clear peak output current CH3 0xA5: Clear peak output current CH4 0xA6: Clear peak output current CH5 0xA7: Clear peak output current CH6	Application reset: Restores configurable parameters to the factory default state, except for the tag information of Index24 to 26.  Back-to-box: Restores configurable parameters to the factory default state, including the tag information of Index24 to 26. After execution, IO-Link communication is disconnected, and the unit enters a restart and reconnection wait state.  Locator Start: Starts high-speed flashing of the IO-Link indicator (green).  Locator Stop: Stops high-speed flashing of the IO-Link indicator (green).
3	0	Data Storage	—	Record	R/W	—	—	—	Used to back up and restore settings with an IO-Link master. *1
13	1	PDInput Descriptor	—	UInteger	R	2 byte	—	0x4000: Common Profile	Indicates the types supported by the S8NR-S as IO-Link functions. *1
	2		—	UInteger	R	2 byte	—	0x8101: Locator	
14	0	PDInput Descriptor	—	Octet	R	12 byte	—	—	
16	0	Vendor Name	—	String	R	64 byte	—	OMRON Corporation	
17	0	Product Name	—	String	R	64 byte	—	OMRON Corporation	
18	0	Product Text	—	String	R	64 byte	—	—	Product model
19	0	Product ID	—	String	R	64 byte	—	—	Product model
20	0	Product Text	—	String	R	64 byte	—	—	Specifications Example) "24V 15A IN: M12-L OUT: 4CH 2xM12-L"
21	0	Serial Number	—	String	R	8 byte	—	—	
22	0	Hardware Version	—	String	R	4 byte	—	—	
23	0	Firmware Version	—	String	R	4 byte	—	—	
24	0	Application Specific Tag	✓	String	R/W	32 byte	*****	Optional	
25	0	Function Tag	✓	String	R/W	32 byte	*****	Optional	
26	0	Location Tag	✓	String	R/W	32 byte	*****	Optional	
36	0	Device Status	—	UInteger	R	1 byte	—	0x00: Device is OK 0x02: Out-of-Specification 0x04: Failure	
37	0	Detailed Device Status	—	Record	R	30 byte	—	Refer to Event function.	Page 5-10
40	0	Process -Data Input	—	Record	R	22 byte	—	Refer to Process data.	Page 5-11

\*1. For details, refer to the IO-Link Specification: IO-Link interface and System Specification V1.1.4 (<https://io-link.com>).

Index	Sub-Index	Name	Back up target	Format	Access	Length	Default value	Range	Remark
65	0	Power Supply events	—	Record	R	2 byte	—	—	Collection of active events of the PSU.
	—	Output-OK	—	Boolean	R	Bit	—	0: OFF 1: ON	Output Voltage is normal. Bit offset 0
	—	DC-Warning	—	Boolean	R	Bit	—	0: OFF 1: ON	Output voltage drop detected. Bit offset 1
	—	Product overheat abnormality	—	Boolean	R	Bit	—	0: OFF 1: ON	Replace a product, as internal parts may be deteriorated. Bit offset 2
	—	Overheating alarm	—	Boolean	R	Bit	—	0: OFF 1: ON	High internal temperature detected in power supply. Cooling action required. Bit offset 3
	—	Over Temperature	—	Boolean	R	Bit	—	0: OFF 1: ON	A temperature exceeding the threshold is detected. Bit offset 4
	—	Over Load	—	Boolean	R	Bit	—	0: OFF 1: ON	Total output load is higher than allowed. Bit offset 5
	—	Abnormal voltage	—	Boolean	R	Bit	—	0: OFF 1: ON	Output voltage is higher than allowed. Bit offset 6
	—	Reserved	—	Boolean	—	Bit	—	—	Bit offset 7
	—	Power Supply down	—	Boolean	R	Bit	—	0: OFF 1: ON	The power supply is turned off. Bit offset 8
	—	Predictive Maintenance Power Supply	—	Boolean	R	Bit	—	0: OFF 1: ON	Performance of Power Supply might be limited. Bit offset 9
	—	Reserved	—	Boolean	—	Bit	—	—	Bit offset 10
	—	Reserved	—	Boolean	—	Bit	—	—	Bit offset 11
	—	Reserved	—	Boolean	—	Bit	—	—	Bit offset 12
	—	Hardware failure	—	Boolean	R	Bit	—	0: OFF 1: ON	Power Supply detected an internal hardware failure. Bit offset 13
—	Reserved	—	Boolean	—	Bit	—	—	Bit offset 14	
—	Reserved	—	Boolean	—	Bit	—	—	Bit offset 15	

Index	Sub-Index	Name	Back up target	Format	Access	Length	Default value	Range	Remark
66	0	Stress level	—	UInteger	R	2 byte	0	0.0 to 999.9 [%]	Stress level based on output power delivery. This parameter gives an indication about the total power consumption of the application and the remaining margin.
67	0	Years until replacement	—	UInteger	R	2 byte	—	0.0 to 15.0 [year]	
68	0	Percentage until replacement	—	UInteger	R	2 byte	—	0.0 to 100 [%]	
69	0	Internal temperature	—	Integer	R	2 byte	—	-20 to 120 [?]	Temperature at secondary DC output area inside PSU.
73	0	Total operating time	—	Record	R	5 byte	—	—	
	—	Hours	—	UInteger	R	4 byte	0	0 to 152000 [hour]	Bit offset 8
	—	Minutes	—	UInteger	R	1 byte	0	0 to 59 [minute]	Bit offset 0
79	0	Present output voltage	—	UInteger	R	2 byte	0	0.0 to 33.0 [V]	
81	0	Total current	—	UInteger	R	2 byte	—	0.0 to 99.9 [A]	
82	0	Turn-on Counter	—	UInteger	R	2 byte	0	0 to 65535 [times]	Turn-on Counter of the PSU.
83	0	Time since last turn-on	—	Record	R	5 byte	—	—	Uptime since last turn-on.
	—	Hours	—	UInteger	R	4 byte	0	0 to 152000 [hour]	Bit offset 8
	—	Minutes	—	UInteger	R	1 byte	0	0 to 59 [minute]	Bit offset 0

Index	Sub-Index	Name	Back up target	Format	Access	Length	Default value	Range	Remark
84	0	Output current	—	Record	R	16 byte	—	—	Branch output current.
	1	Branch output 1	—	UInteger	R	2 byte	0	0.0 to 20.0 [A]	
	2	Branch output 2	—	UInteger	R	2 byte	0	0.0 to 20.0 [A]	
	3	Branch output 3	—	UInteger	R	2 byte	0	0.0 to 20.0 [A]	
	4	Branch output 4	—	UInteger	R	2 byte	0	0.0 to 20.0 [A]	
	5	Branch output 5	—	UInteger	R	2 byte	0	0.0 to 20.0 [A]	Applicable only to S8NR-S60024
	6	Branch output 6	—	UInteger	R	2 byte	0	0.0 to 20.0 [A]	Applicable only to S8NR-S60024

Index	Sub-Index	Name	Back up target	Format	Access	Length	Default value	Range	Remark
85	0	Status	—	Record	R	1 byte	—	—	Output state of Branch outputs.
	1	Branch output 1	—	Boolean	R	Bit	0	0: OFF 1: ON	
	2	Branch output 2	—	Boolean	R	Bit	0	0: OFF 1: ON	
	3	Branch output 3	—	Boolean	R	Bit	0	0: OFF 1: ON	
	4	Branch output 4	—	Boolean	R	Bit	0	0: OFF 1: ON	
	5	Branch output 5	—	Boolean	R	Bit	0	0: OFF 1: ON	Applicable only to S8NR-S60024
	6	Branch output 6	—	Boolean	R	Bit	0	0: OFF 1: ON	Applicable only to S8NR-S60024

Index	Sub-Index	Name	Back up target	Format	Access	Length	Default value	Range	Remark
86	0	Trip status	—	Record	R	8 byte	—	—	Trip state of Branch output. If the Branch output has tripped, this parameter gives detailed information about the reason.
	1	Branch output 1	—	UInteger	R	1 byte	0	0 to 8	0: No trip 1: Overload trip) 2: Short circuit trip 3: Protection circuit trip 4: Total overload trip 5: Abnormal voltage trip 6: Hardware failure trip 7: External tripping input trip 8: Manual trip
	2	Branch output 2	—	UInteger	R	1 byte	0	0 to 8	
	3	Branch output 3	—	UInteger	R	1 byte	0	0 to 8	
	4	Branch output 4	—	UInteger	R	1 byte	0	0 to 8	
	5	Branch output 5	—	UInteger	R	1 byte	0	0 to 8	Applicable only to S8NR-S60024
	6	Branch output 6	—	UInteger	R	1 byte	0	0 to 8	Applicable only to S8NR-S60024

Index	Sub-Index	Name	Back up target	Format	Access	Length	Default value	Range	Remark
87	0	Number of startups	—	Record	R	16 byte	—	—	Counts the number of startups on each Branch output.
	1	Branch output 1	—	UInteger	R	2 byte	0	0 to 65535 [times]	
	2	Branch output 2	—	UInteger	R	2 byte	0	0 to 65535 [times]	
	3	Branch output 3	—	UInteger	R	2 byte	0	0 to 65535 [times]	
	4	Branch output 4	—	UInteger	R	2 byte	0	0 to 65535 [times]	
	5	Branch output 5	—	UInteger	R	2 byte	0	0 to 65535 [times]	Applicable only to S8NR-S60024
	6	Branch output 6	—	UInteger	R	2 byte	0	0 to 65535 [times]	Applicable only to S8NR-S60024

Index	Sub-Index	Name	Back up target	Format	Access	Length	Default value	Range	Remark
88	0	Number of overcurrents	—	Record	R	16 byte	—	—	Number of Overcurrents on each Branch output.
	1	Branch output 1	—	UInteger	R	2 byte	0	0 to 65535 [times]	
	2	Branch output 2	—	UInteger	R	2 byte	0	0 to 65535 [times]	
	3	Branch output 3	—	UInteger	R	2 byte	0	0 to 65535 [times]	
	4	Branch output 4	—	UInteger	R	2 byte	0	0 to 65535 [times]	
	5	Branch output 5	—	UInteger	R	2 byte	0	0 to 65535 [times]	Applicable only to S8NR-S60024
	6	Branch output 6	—	UInteger	R	2 byte	0	0 to 65535 [times]	Applicable only to S8NR-S60024

Index	Sub-Index	Name	Back up target	Format	Access	Length	Default value	Range	Remark
89	0	Peak output current	—	Record	R	16 byte	—	—	Peak output current of each branch output.
	1	Branch output 1	—	UInteger	R	2 byte	0.0	20.0	
	2	Branch output 2	—	UInteger	R	2 byte	0.0	20.0	
	3	Branch output 3	—	UInteger	R	2 byte	0.0	20.0	
	4	Branch output 4	—	UInteger	R	2 byte	0.0	20.0	
	5	Branch output 5	—	UInteger	R	2 byte	0.0	20.0	Applicable only to S8NR-S60024
	6	Branch output 6	—	UInteger	R	2 byte	0.0	20.0	Applicable only to S8NR-S60024

Index	Sub-Index	Name	Back up target	Format	Access	Length	Default value	Range	Remark
90	0	Remaining output current	—	Record	R	16 byte	—	—	Remaining output current of each branch output.
	1	Branch output 1	—	UInteger	R	2 byte	0.0	10.0	
	2	Branch output 2	—	UInteger	R	2 byte	0.0	10.0	
	3	Branch output 3	—	UInteger	R	2 byte	0.0	10.0	
	4	Branch output 4	—	UInteger	R	2 byte	0.0	10.0	
	5	Branch output 5	—	UInteger	R	2 byte	0.0	10.0	Applicable only to S8NR-S60024
	6	Branch output 6	—	UInteger	R	2 byte	0.0	10.0	Applicable only to S8NR-S60024

Index	Sub-Index	Name	Back up target	Format	Access	Length	Default value	Range	Remark
101	0	Standby	—	Boolean	R/W	Bit	0	0: OFF 1: ON	PSU can be switched into standby, where all outputs turn off.
102	0	Protection level	—	UInteger	R/W	1 byte	1	0: Lv0 1: Lv1 2: Lv2 3: Lv3	The function can be set to restrict access to the parameters.
103	0	CH Key	—	UInteger	R/W	1 byte	1	0: Disabled 1: Enabled	Controls the configurability of ON/OFF Button.
104	0	Total current pre-alarm level	—	UInteger	R/W	2 byte	100.0	0 to 100.0 [A]	Defines the threshold for the event "Output current pre-alarm".
105	0	Output Voltage Setpoint	—	UInteger	R/W	2 byte	24.1	24.0 to 28.0 [V]	Output Voltage Setpoint.

Index	Sub-Index	Name	Back up target	Format	Access	Length	Default value	Range	Remark
106	0	Branch output on/off	—	Record	R/W	1 byte	—	—	Used to control the state of Branch output switches (ON/OFF) or to reconnect a tripped Branch output.
	—	Branch output 1	—	Boolean	R/W	Bit	1	0: OFF 1: ON	Bit offset 0
	—	Branch output 2	—	Boolean	R/W	Bit	1	0: OFF 1: ON	Bit offset 1
	—	Branch output 3	—	Boolean	R/W	Bit	1	0: OFF 1: ON	Bit offset 2
	—	Branch output 4	—	Boolean	R/W	Bit	1	0: OFF 1: ON	Bit offset 3
	—	Branch output 5	—	Boolean	R/W	Bit	1	0: OFF 1: ON	Bit offset 4 Applicable only to S8NR-S60024
	—	Branch output 6	—	Boolean	R/W	Bit	1	0: OFF 1: ON	Bit offset 5 Applicable only to S8NR-S60024

Index	Sub-Index	Name	Back up target	Format	Access	Length	Default value	Range	Remark
107	0	Current tripping type	—	Record	R/W	16 byte	—	—	The types of control methods or judgment criteria used to shut off the output when the current flowing through the output circuit exceeds a predefined threshold.
	1	Branch output 1	—	UInteger	R/W	2 byte	0	0: Standard 1: Instantaneous 2: Extended	
	2	Branch output 2	—	UInteger	R/W	2 byte	0		
	3	Branch output 3	—	UInteger	R/W	2 byte	0		
	4	Branch output 4	—	UInteger	R/W	2 byte	0		
	5	Branch output 5	—	UInteger	R/W	2 byte	0		Applicable only to S8NR-S60024
	6	Branch output 6	—	UInteger	R/W	2 byte	0		Applicable only to S8NR-S60024

Index	Sub-Index	Name	Back up target	Format	Access	Length	Default value	Range	Remark
108	0	Current tripping threshold	—	Record	R/W	16 byte	—	—	Defines the output current threshold for each Branch output.
	1	Branch output 1	—	UInteger	R/W	2 byte	10.0	0.5 to 10.0 [A]	Applicable models • S8NR-S36024-A0L2-IL3 • S8NR-S60024-A0L3-IL3
								0.5 to 3.8 [A]	Applicable models • S8NR-S36024-A2L1-IL3 • S8NR-S60024-A2L2-IL3
	2	Branch output 2	—	UInteger	R/W	2 byte	10.0	0.5 to 10.0 [A]	Applicable models • S8NR-S36024-A0L2-IL3 • S8NR-S60024-A0L3-IL3
								0.5 to 3.8 [A]	Applicable models • S8NR-S36024-A2L1-IL3 • S8NR-S60024-A2L2-IL3
	3	Branch output 3	—	UInteger	R/W	2 byte	10.0	0.5 to 10.0 [A]	All models are applicable.
	4	Branch output 4	—	UInteger	R/W	2 byte	10.0	0.5 to 10.0 [A]	All models are applicable.
	5	Branch output 5	—	UInteger	R/W	2 byte	10.0	0.5 to 10.0 [A]	Applicable models • S8NR-S60024-A0L3-IL3 • S8NR-S60024-A2L2-IL3
6	Branch output 6	—	UInteger	R/W	2 byte	10.0	0.5 to 10.0 [A]	Applicable models • S8NR-S60024-A0L3-IL3 • S8NR-S60024-A2L2-IL3	

Index	Sub-Index	Name	Back up target	Format	Access	Length	Default value	Range	Remark
109	0	Current pre-alarm level	—	Record	R/W	16 byte	—	—	Defines the threshold for the event "current pre-alarm" for each Branch output.
	1	Branch output 1	—	UInteger	R/W	2 byte	100.0	10.0 to 100.0 [A]	
	2	Branch output 2	—	UInteger	R/W	2 byte	100.0	10.0 to 100.0 [A]	
	3	Branch output 3	—	UInteger	R/W	2 byte	100.0	10.0 to 100.0 [A]	
	4	Branch output 4	—	UInteger	R/W	2 byte	100.0	10.0 to 100.0 [A]	
	5	Branch output 5	—	UInteger	R/W	2 byte	100.0	10.0 to 100.0 [A]	Applicable only to S8NR-S60024
	6	Branch output 6	—	UInteger	R/W	2 byte	100.0	10.0 to 100.0 [A]	Applicable only to S8NR-S60024

Index	Sub-Index	Name	Back up target	Format	Access	Length	Default value	Range	Remark
110	0	Startup sequence	—	Record	R/W	16 byte	—	—	A function that controls the order and timing of each output during power-on.
	1	Branch output 1	—	UInteger	R/W	2 byte	0	0.0 to 99.9 [s]	
	2	Branch output 2	—	UInteger	R/W	2 byte	0.4	0.0 to 99.9 [s]	
	3	Branch output 3	—	UInteger	R/W	2 byte	0.8	0.0 to 99.9 [s]	
	4	Branch output 4	—	UInteger	R/W	2 byte	1.2	0.0 to 99.9 [s]	
	5	Branch output 5	—	UInteger	R/W	2 byte	1.6	0.0 to 99.9 [s]	Applicable only to S8NR-S60024
	6	Branch output 6	—	UInteger	R/W	2 byte	2.0	0.0 to 99.9 [s]	Applicable only to S8NR-S60024

Index	Sub-Index	Name	Back up target	Format	Access	Length	Default value	Range	Remark
111	0	Shutdown sequence	—	Record	R/W	16 byte	—	—	A function that controls the order and timing of shutting down each device or output when turning off the system.
	1	Branch output 1	—	UInteger	R/W	2 byte	0.0	0.0 to 99.9 [s]	
	2	Branch output 2	—	UInteger	R/W	2 byte	0.0	0.0 to 99.9 [s]	
	3	Branch output 3	—	UInteger	R/W	2 byte	0.0	0.0 to 99.9 [s]	
	4	Branch output 4	—	UInteger	R/W	2 byte	0.0	0.0 to 99.9 [s]	
	5	Branch output 5	—	UInteger	R/W	2 byte	0.0	0.0 to 99.9 [s]	Applicable only to S8NR-S60024
	6	Branch output 6	—	UInteger	R/W	2 byte	0.0	0.0 to 99.9 [s]	Applicable only to S8NR-S60024

Index	Sub-Index	Name	Back up target	Format	Access	Length	Default value	Range	Remark
112	0	Abnormal voltage tripping threshold	—	UInteger	R/W	2 byte	32.0	24.0 to 32.0 [V]	A threshold value used to determine when the output voltage exceeds a predefined limit and is considered abnormal, triggering the shutdown of the power output.
114	0	Undervoltage detection threshold	—	UInteger	R/W	2 byte	20.0	18.0 to 28.0 [V]	The undervoltage detection output is output when the output voltage falls below this detection threshold. Branch outputs will not be cut off.
115	0	Over-temperature output threshold	—	UInteger	R/W	2 byte	120	25 to 120 [°C]	Configure the threshold for over-temperature alarm detection.
116	0	Years threshold until replacement	—	UInteger	R/W	2 byte	5	0 to 50 [years]	Configure the threshold for year until replacement.
117	0	Percentage threshold until replacement	—	UInteger	R/W	2 byte	0	0 to 99.9 [%]	Configure the threshold for percentage until replacement.
118	0	Total operating time threshold	—	UInteger	R/W	2 byte	132	0 to 132 [×1000 hour]	Configure the threshold for total operating time.
119	0	Alarm reset setting	—	UInteger	R/W	1 byte	1	0: RST key only enabled 1: RST key and power reapplication	Configure how to Clearing Errors.

Index	Sub-Index	Name	Back up target	Format	Access	Length	Default value	Range	Remark
123	0	External tripping input function setting	—	UInteger	R/W	1 byte	0	0: Edge 1: Level	Sets the external tripping input trigger signal type.
125	0	External tripping input	—	Boolean	R/W	Bit	0	0: OFF 1: ON	Trip via external tripping input function.

Index	Sub-Index	Name	Back up target	Format	Access	Length	Default value	Range	Remark
124	0	External tripping input cutoff for branch	—	Record	R/W	1 byte	—	—	Enables the external tripping input function for each branch output.
	—	Branch output 1	—	Boolean	R/W	Bit	1	0: Disabled 1: Enabled	Bit offset 0
	—	Branch output 2	—	Boolean	R/W	Bit	1	0: Disabled 1: Enabled	Bit offset 1
	—	Branch output 3	—	Boolean	R/W	Bit	1	0: Disabled 1: Enabled	Bit offset 2
	—	Branch output 4	—	Boolean	R/W	Bit	1	0: Disabled 1: Enabled	Bit offset 3
	—	Branch output 5	—	Boolean	R/W	Bit	1	0: Disabled 1: Enabled	Bit offset 4 Applicable only to S8NR-S60024
	—	Branch output 6	—	Boolean	R/W	Bit	1	0: Disabled 1: Enabled	Bit offset 5 Applicable only to S8NR-S60024

## Event function (Index: 37)

Event Code	Event function	Type	Description
0x1803	Breakdown	Error	Restart or replace the product.
0x1806	DC-Warning	Warning	Output voltage drop detected.
0x1807	Over Load	Warning	Total output load is higher than allowed.
0x1808	Power Supply down	Warning	The power supply module is not input.
0x1809	Predictive Maintenance Power Supply	Warning	Performance of Power Supply might be limited.
0x180A	Output current pre-alarm	Warning	Total output current exceeded the Total current pre-alarm level.
0x180B	Branch output 1 tripped	Warning	Branch output 1 has tripped due to overload, short circuit or any other fault condition.
0x180C	Branch output 2 tripped	Warning	Branch output 2 has tripped due to overload, short circuit or any other fault condition.
0x180D	Branch output 3 tripped	Warning	Branch output 3 has tripped due to overload, short circuit or any other fault condition.
0x180E	Branch output 4 tripped	Warning	Branch output 4 has tripped due to overload, short circuit or any other fault condition.
0x180F	Branch output 5 tripped	Warning	Branch output 5 has tripped due to overload, short circuit or any other fault condition.
0x1810	Branch output 6 tripped	Warning	Branch output 6 has tripped due to overload, short circuit or any other fault condition.
0x1813	Branch output 1 current pre-alarm	Notification	Output current of Branch output 1 exceeded the pre-alarm level.
0x1814	Branch output 2 current pre-alarm	Notification	Output current of Branch output 2 exceeded the pre-alarm level.
0x1815	Branch output 3 current pre-alarm	Notification	Output current of Branch output 3 exceeded the pre-alarm level.
0x1816	Branch output 4 current pre-alarm	Notification	Output current of Branch output 4 exceeded the pre-alarm level.
0x1817	Branch output 5 current pre-alarm	Notification	Output current of Branch output 5 exceeded the pre-alarm level.
0x1818	Branch output 6 current pre-alarm	Notification	Output current of Branch output 6 exceeded the pre-alarm level.
0x181B	Overheating alarm	Warning	High internal temperature detected in power supply. Cooling action required.
0x181C	Product overheat abnormality	Error	Replace a product, as internal parts may be deteriorated.
0x181D	Abnormal voltage trip	Warning	All branch output have tripped due to the the output voltage exceeding the threshold.
0x4210	Device temperature overrun	Warning	Clear source of heat.
0x6320	Parameter error	Error	Check data sheet and values.

## Process data (Index: 40)

Two types of process data are provided, depending on the model. They are shown below.

### ● Process data for S8NR-S36024-A0L2-IL3 and S8NR-S36024-A2L1-IL3

Sub-Index	bit offset *1	Data type	Name	Range
1	160	16-bit Integer	Total current	0.0 to 99.9 [A]
2	144	16-bit Integer	Present output voltage	0.0 to 33.0 [V]
3	128	16-bit Integer	Present current, branch output 1	0.0 to 20.0 [A]
4	112	16-bit Integer	Present current, branch output 2	0.0 to 20.0 [A]
5	96	16-bit Integer	Present current, branch output 3	0.0 to 20.0 [A]
6	80	16-bit Integer	Present current, branch output 4	0.0 to 20.0 [A]
15	11	Boolean	State, branch output 4	0: OFF 1: ON
16	10	Boolean	State, branch output 3	0: OFF 1: ON
17	9	Boolean	State, branch output 2	0: OFF 1: ON
18	8	Boolean	State, branch output 1	0: OFF 1: ON
23	3	Boolean	Trip state, branch output 4	0: OFF (no cutoff) 1: ON (cutoff in progress) *2
24	2	Boolean	Trip state, branch output 3	0: OFF (no cutoff) 1: ON (cutoff in progress) *2
25	1	Boolean	Trip state, branch output 2	0: OFF (no cutoff) 1: ON (cutoff in progress) *2
26	0	Boolean	Trip state, branch output 1	0: OFF (no cutoff) 1: ON (cutoff in progress) *2

\*1. For details, refer to the IO-Link Specification: IO-Link interface and System Specification V1.1.4 (<https://io-link.com>).

\*2. This "1: ON (cutoff in progress)" turns ON when one of the following trips occurs.

- 1: Overload trip
- 2: Short circuit trip
- 3: Protection circuit trip
- 4: Total overload trip
- 5: Abnormal voltage trip
- 6: Hardware failure trip

(Corresponds to 1 to 6 shown in Index 87: Trip status. 7: External tripping input trip and 8: Manual trip are not included in the ON condition.)

### ● Process data for S8NR-S60024-A0L3-IL3 and S8NR-S60024-A2L2-IL3

Sub-Index	bit offset *1	Data type	Name	Range
1	160	16-bit Integer	Total current	0.0 to 99.9 [A]
2	144	16-bit Integer	Present output voltage	0.0 to 33.0 [V]
3	128	16-bit Integer	Present current, branch output 1	0.0 to 20.0 [A]
4	112	16-bit Integer	Present current, branch output 2	0.0 to 20.0 [A]
5	96	16-bit Integer	Present current, branch output 3	0.0 to 20.0 [A]
6	80	16-bit Integer	Present current, branch output 4	0.0 to 20.0 [A]
7	64	16-bit Integer	Present current, branch output 5	0.0 to 20.0 [A]
8	48	16-bit Integer	Present current, branch output 6	0.0 to 20.0 [A]
13	13	Boolean	State, branch output 6	0: OFF 1: ON
14	12	Boolean	State, branch output 5	0: OFF 1: ON
15	11	Boolean	State, branch output 4	0: OFF 1: ON
16	10	Boolean	State, branch output 3	0: OFF 1: ON
17	9	Boolean	State, branch output 2	0: OFF 1: ON
18	8	Boolean	State, branch output 1	0: OFF 1: ON
21	5	Boolean	Trip state, branch output 6	0: OFF (no cutoff) 1: ON (cutoff in progress) *2
22	4	Boolean	Trip state, branch output 5	0: OFF (no cutoff) 1: ON (cutoff in progress) *2
23	3	Boolean	Trip state, branch output 4	0: OFF (no cutoff) 1: ON (cutoff in progress) *2
24	2	Boolean	Trip state, branch output 3	0: OFF (no cutoff) 1: ON (cutoff in progress) *2
25	1	Boolean	Trip state, branch output 2	0: OFF (no cutoff) 1: ON (cutoff in progress) *2
26	0	Boolean	Trip state, branch output 1	0: OFF (no cutoff) 1: ON (cutoff in progress) *2

\*1. For details, refer to the IO-Link Specification: IO-Link interface and System Specification V1.1.4 (<https://io-link.com>).

\*2. This "1: ON (cutoff in progress)" turns ON when one of the following trips occurs.

- 1: Overload trip
- 2: Short circuit trip
- 3: Protection circuit trip
- 4: Total overload trip
- 5: Abnormal voltage trip
- 6: Hardware failure trip

(Corresponds to 1 to 6 shown in Index 87: Trip status. 7: External tripping input trip and 8: Manual trip are not included in the ON condition.)

# 6

## Trial Operation to Actual Operation

---

6-1 Trial run .....	6-2
6-2 Connection/Disconnection Test .....	6-3

## 6-1 Trial run

Before starting actual operation of the equipment, each branch output can be manually activated individually to check the connection state.

Operation at startup also can be checked.

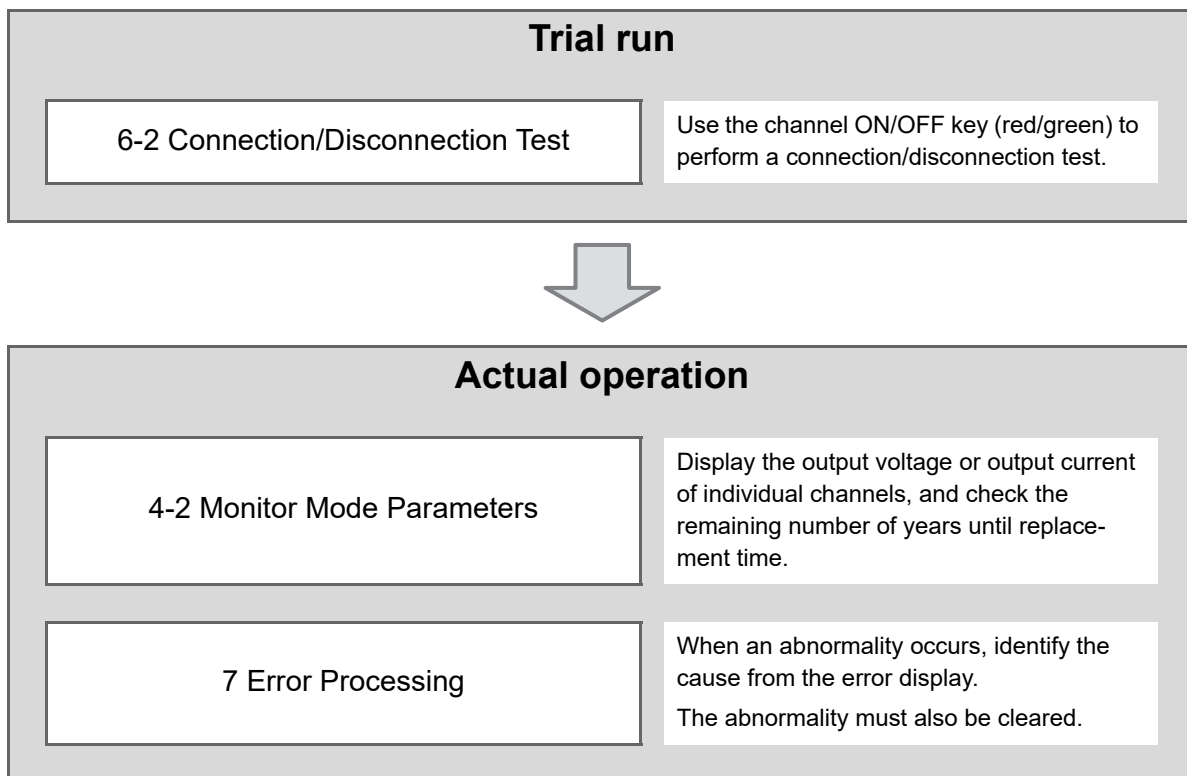

## 6-2 Connection/Disconnection Test

Before performing the connection/disconnection test, always sufficiently check that it is safe to do so and will not adversely affect the equipment.

Check that each individual circuit can be manually connected and disconnected using the channel ON/OFF key. Check that each individual circuit can be connected/tripped (disconnected) and that there are no problems.

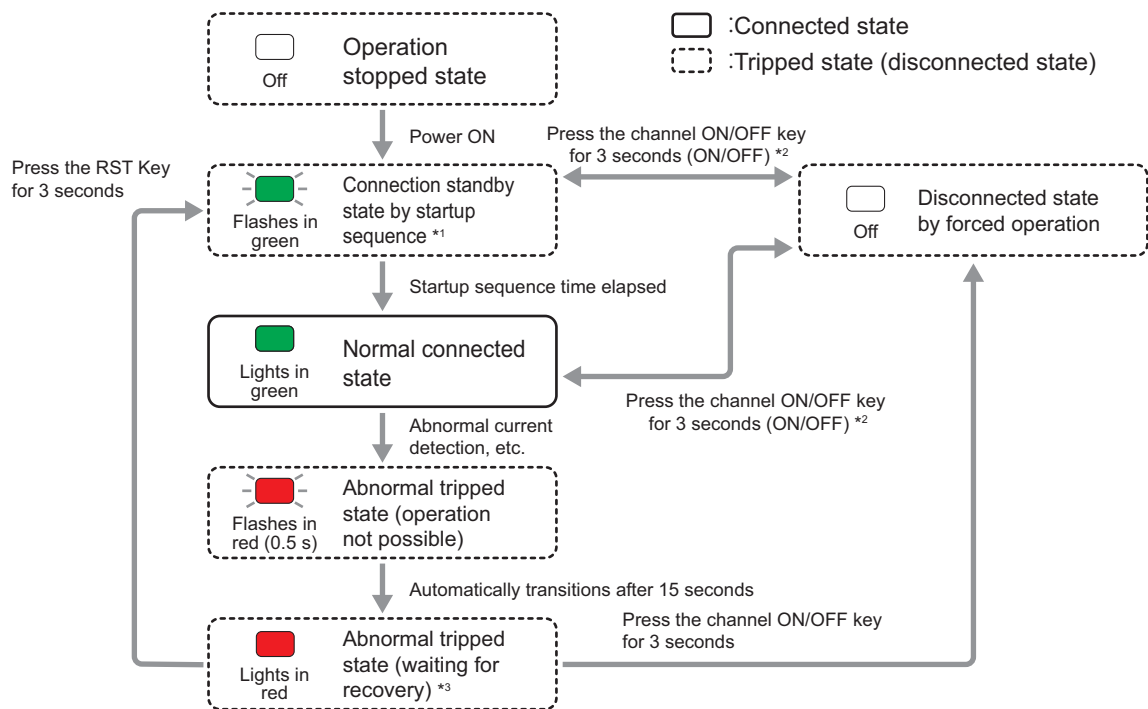

\*1. When 0 s is set to the startup sequence, the branch output is connected normally without waiting for the connection.

\*2. When ON/OFF operation is performed continuously, OFF is switched to ON only after at least 3 seconds have elapsed since the previous ON.

\*3. If a tripped state occurs due to an internal error (waiting for recovery), the indicator flashes in red at 0.25 second intervals.





# Error Processing

---

Measures to take in the event of an anomaly for model S8NR-S are explained below.

---

<b>7-1 Troubleshooting</b> .....	<b>7-2</b>
<b>7-2 Eleven-segment Error Codes</b> .....	<b>7-4</b>
<b>7-3 Clearing Errors</b> .....	<b>7-6</b>

# 7-1 Troubleshooting

If the S8NR-S is not operating properly, check the items listed in the following table before requesting repairs. If the problem cannot be remedied, contact your OMRON sales representative.

	Observed problem	Possible cause	Remedy	Reference page
Parameter settings	The desired parameter is not being displayed.	The setting is not allowed in the present protection level.	Change the protection level setting.	Page 4-12
	The set value was changed, but the change wasn't accepted.	The new setting was not saved.	After changing the numerical value with the select up/down keys, press the ENT key to make the value flash, then press the ENT key again. When the set value is applied, "set" is displayed.	Page 4-8 Page 4-8
	The branch outputs are not working.	Branch outputs are tripped by the channel ON/OFF key.	Press the channel ON/OFF key to connect the branch outputs.	Page 6-3
Equipment setup	After connecting in the Setting Mode, the connection was immediately tripped and a re-connection was no longer possible.	Check to see if the channel ON/OFF key is lit red. The current may be higher than the abnormal current tripping threshold.	Check for problems such as output wiring and load connection problems. If no problems are found, press the reset key.	Page 6-2 Page 7-6
Operation	An error code is displayed. You checked the status and removed the cause, but the error is not cleared.	To ensure that temporary abnormalities are not overlooked, the S8NR-S retains the display output once an alarm occurs, even after the condition is cleared.	Press the reset key to clear the indication.	Page 7-6
	The peak output current is not displayed and the display shows "--."	The current may have exceeded the measurable range.	Clear the peak output current in Run Mode.	Page 4-5
	The output was not designed for a current that high, but the output is cut off as soon as power is supplied.	The abnormal current tripping type may be set to "instantaneous." With instantaneous detection, an abnormal current is detected very quickly and the output may be cut off due to excessive current during equipment operation.	Either change the abnormal current tripping type from instantaneous to standard or increase the current tripping threshold.	Page 2-17 Page 4-8 Page 4-8
		There may be a large number of devices connected to the output. The more devices that are connected, the higher the operating current.	Connect the devices to different branch outputs and use the S8NR-S's startup sequence to offset the connections to the devices.	Page 2-28 Page 4-10

	Observed problem	Possible cause	Remedy	Reference page
Branch output cutoff	After tripping, normal operation cannot be restored by pressing the reset key.	To protect its internal circuits, the S8NR-S requires at least 15 seconds after tripping before it can be reset.	The product cannot be reset while the channel ON/OFF key is flashing in red. Before performing a reset, check that the key is lit red.	Page 2-17 Page 7-6
	The output was reset, but it was immediately cut off again.	The original cause of the cutoff may not have been eliminated.  After resetting the error, a large current may have flowed again.	Eliminate the problem that caused the cutoff and press the reset key.	Page 7-6
Saving or maintenance	"E06" (abnormal overheating state) is displayed.	If the overheating state continues for 3 hours or more, the overheating alarm (A23/HOT alternating display) can no longer be cleared. (This is because the power supply life expectancy can no longer be calculated correctly.)	Use the product under operating conditions that prevent prolonged overheating.	Page 1-13
	After initializing parameters, all outputs became connected.	"Initialize defaults" returns the various settings to their factory default settings.  At shipment from the factory, all branch outputs are set to a connected state.	After using "Initialize defaults," mode changes to the Run Mode. Transition to the Test Mode and redo the connection/disconnection settings.	Page 4-5

## 7-2 Eleven-segment Error Codes

### Error Display List

Eleven-segment display	Error code	Meaning	Probable cause and remedy	
<i>ERP</i>	ERP	Power supply circuit error	<p>These are S8NR-S system errors.</p> <p>When one of these error codes is displayed, check the system configuration and clear the error, and then turn the power supply OFF and ON again.</p> <p>If the error code persists, contact your OMRON representative regarding the error.</p>	
.	-	Arithmetic circuit error		
<i>E98</i>	E98	RAM error		
<i>E97</i>	E97	EEPROM read error		
<i>E96</i>	E96	EEPROM write error		
<i>E94</i>	E94	Branch circuit error		
<i>E00</i>	E00	EEPROM initialization error		
<i>E01</i>	E01	EEPROM error		
<i>E02</i>	E02	Model error		
<i>E03</i>	E03	Factory default detection mode		
<i>E06</i>	E06	Product overheating error	An overheating state has continued for over 180 minutes.	Internal components may have degraded, so replace the main unit.
<i>E10</i>	E10	Data is corrupted.	There is an error in the parameter settings.	Press the Mode Key to switch to the parameter initialization display. After initializing the parameters, set them again.
<i>R10</i>	A10	Abnormal Voltage Tripping	The power supply voltage has exceeded the abnormal voltage tripping threshold.	Check the power supply voltage.
<i>R11</i>	A11	Abnormal current tripping	The branch output's current exceeded the current tripping threshold.	Check whether the connected device is correct and check whether the set value is appropriate.
<i>R12</i>	A12	Total current tripping	All branch outputs were cutoff because the total current and the power-ON time exceeded the abnormal total current tripping conditions.	Check whether the connected devices are suitable and operating within the total current limit.
<i>R21</i>	A21	Undervoltage alarm	The output voltage dropped below the undervoltage detection threshold.	Check the power supply voltage and the set value.

Eleven-segment display	Error code	Meaning	Probable cause and remedy	
<i>A23</i>	A23	The unit for this is displayed in 3 ways: Yrs lit: Remaining years until replacement % lit: Remaining percentage until replacement kH lit: Running time alarm	The replacement time calculated by the S8NR-S is lower than the notification time.	Indicates that the replacement time is approaching.
<i>A23/Hōt</i>	A23/HOT	Overheating alarm	The S8NR-S is overheated.	Take steps to reduce the internal temperature.
<i>A30</i>	A30	Over-temperature output	The S8NR-S 's internal temperature exceeded the over-temperature output threshold.	Check for an increase in ambient temperature and verify the settings. Take corrective actions to reduce the ambient temperature and the total output current.

Branch Output Number Indicator	Error code	Meaning	Probable cause and remedy	
	-	Measurement circuit is in a standby state.	This is displayed temporarily when the power is interrupted. If this is displayed when the power is turned ON, this may indicate a malfunction. If this is displayed at all times, cycle the power supply. If the error code persists, contact your OMRON representative regarding the error.	

- When two or more errors occur simultaneously, the higher priority error (higher in the table above) will be displayed.
- The A11 error may occur simultaneously in two or more branch outputs. In this case, the branch output number LED for the A11 error that occurs later is not displayed.

## 7-3 Clearing Errors

When an error has occurred, the error code will be displayed on the eleven-segment display.

Eliminate the cause of the error and clear the error display.

To clear the error display, 15 seconds or more must have elapsed since tripping to protect the internal circuits.

There are 3 ways to clear an error. The following describes each of these ways.

- Reset key
- Cycle the power supply
- Channel ON/OFF key

### Clearing Errors with the Reset Key

Hold the Reset key down for at least 3 seconds. This clears the error and reconnects the tripped circuit.

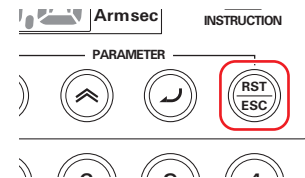

After holding down for 3 seconds, "rst" will be displayed on the eleven-segment display.



Note, however, that the reset operation will be invalid and the error cannot be cleared in the following states:

- From the parameter display screen in Setting Mode
- From the Yes/No display when clearing the peak current
- From the parameter initialization Yes/No display
- When an E\*\* error has occurred

### Clearing Errors by Turning Power OFF and ON

Branch outputs that have been cut off can be reconnected by turning the input power OFF and then ON again. This function can be enabled or disabled by setting the Reset Method Setting (RST) parameter. The default setting allows errors to be reset by turning the power supply OFF and ON again.

## Clearing Error by Channel ON/OFF Key

Pressing the “channel ON/OFF key” toggles the target circuit between the connected and tripped (disconnected) state.

Eliminate the cause of the error and clear the error display.

When in an abnormal tripped state with the light lit red (waiting for recovery), pressing the channel ON/OFF key once will switch to the light OFF disconnected state.

Pressing the key again changes the state to the connected state with the light lit green to indicate that the product has recovered.

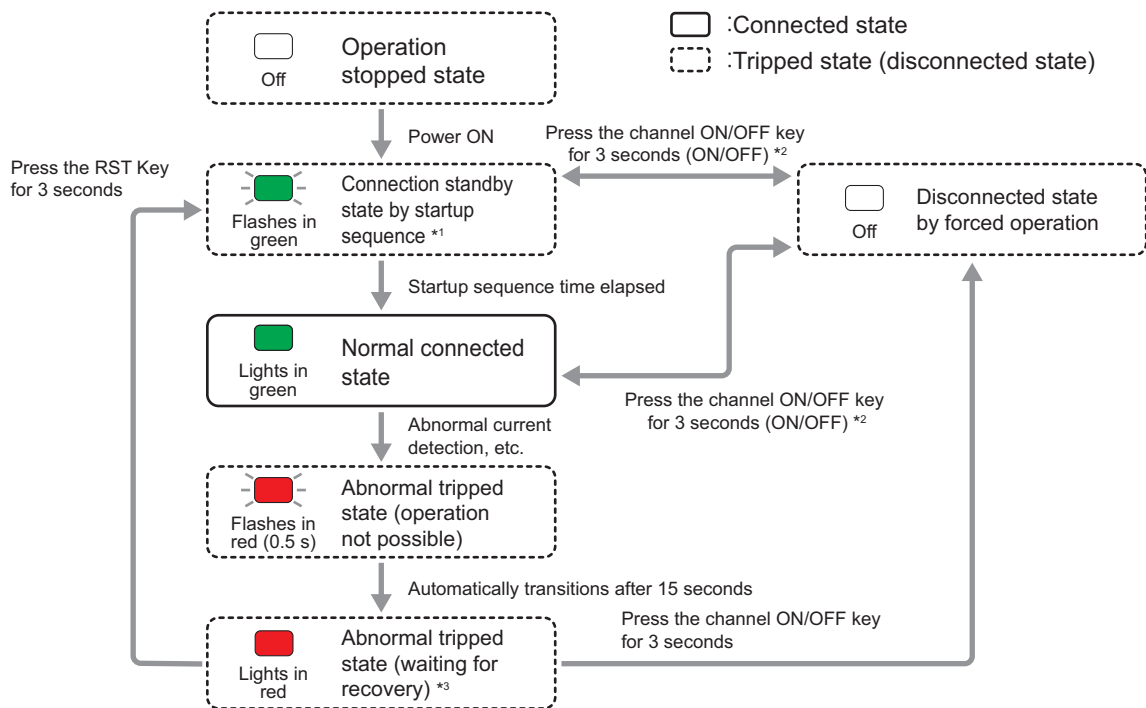

\*1. When 0 s is set to the startup sequence, the branch output is connected normally without waiting for the connection.

\*2. When ON/OFF operation is performed continuously, OFF is switched to ON only after at least 3 seconds have elapsed since the previous ON.

\*3. If a tripped state occurs due to an internal error (waiting for recovery), the indicator flashes in red at 0.25 second intervals.



### Additional Information

When there is no reaction by pressing the “channel ON/OFF key,” check the following parameter setting.

- Check to see if parameter “Channel ON/OFF key enable/disable” is not set to “Disabled” (default: Enabled).

## Identifying and Correcting the Cause of the Error

---

When an error code is displayed on the eleven-segment display, determine whether an error actually occurred or there is a problem with the parameter setting.

### ● Correcting Abnormal Current Tripping (A11) Errors

When error code A11 (abnormal current tripping) and the current are displayed alternately on the eleven-segment display, there are two possible causes. Check whether the load connected to the output is too large or the current setting is too low.

- If there are too many loads connected, split up the loads.
- If the current setting is too low, increase the setting.
- If the overcurrent is occurring momentarily, check the abnormal current tripping type setting on page 4-8.

The detection of short-lived abnormal currents can be prevented by changing the setting from instantaneous detection (detection after 10 ms) to standard detection (detection after 80 ms).

### ● Over-temperature Output (A30) Displayed

When error code A30 (over-temperature) and the temperature are displayed alternately on the eleven-segment display, there are two possible causes. Check whether the S8NR-S's internal temperature is too high or the setting of the over-temperature output threshold is too low.

### ● Maintenance Forecast Monitor Output (A23) Displayed

When error code A23 (maintenance forecast monitor output) is displayed on the eleven-segment display, it indicates that the replacement time calculated by the S8NR-S has fallen below the set value. Prepare to replace the Power Supply.



**OMRON Corporation Industrial Automation Company**

**Kyoto, JAPAN**

**Contact : [www.ia.omron.com](http://www.ia.omron.com)**

**Regional Headquarters**

**OMRON EUROPE B.V.**

Wegalaan 67-69, 2132 JD Hoofddorp  
The Netherlands  
Tel: (31) 2356-81-300 Fax: (31) 2356-81-388

**OMRON ASIA PACIFIC PTE. LTD.**

438B Alexandra Road, #08-01/02 Alexandra  
Technopark, Singapore 119968  
Tel: (65) 6835-3011 Fax: (65) 6835-3011

**OMRON ELECTRONICS LLC**

2895 Greenspoint Parkway, Suite 200  
Hoffman Estates, IL 60169 U.S.A.  
Tel: (1) 847-843-7900 Fax: (1) 847-843-7787

**OMRON (CHINA) CO., LTD.**

Room 2211, Bank of China Tower,  
200 Yin Cheng Zhong Road,  
PuDong New Area, Shanghai, 200120, China  
Tel: (86) 21-6023-0333 Fax: (86) 21-5037-2388

**Authorized Distributor:**

©OMRON Corporation 2025 All Rights Reserved.  
In the interest of product improvement,  
specifications are subject to change without notice.

**Cat. No. T245-E1-01 0426**