

## **NB-series**

**NB3Q-TW□□B(-V1)**

**NB5Q-TW□□B(-V1)**

**NB7W-TW□□B(-V1)**

**NB10W-TW01B(-V1)**

# **Programmable Terminals**

# **HOST CONNECTION MANUAL**

# **OMRON**

## NOTE

All rights reserved. No part of this publication may be reproduced, stored in a retrieval system, or transmitted, in any form, or by any means, mechanical, electronic, photocopying, recording, or otherwise, without the prior written permission of OMRON.

No patent liability is assumed with respect to the use of the information contained herein. Moreover, because OMRON is constantly striving to improve its high-quality products, the information contained in this manual is subject to change without notice. Every precaution has been taken in the preparation of this manual. Nevertheless, OMRON assumes no responsibility for errors or omissions. Neither is any liability assumed for damages resulting from the use of the information contained in this publication.

## Trademarks

- Sysmac and SYSMAC are trademarks or registered trademarks of OMRON Corporation in Japan and other countries for OMRON factory automation products.
- Microsoft, Windows, Windows Vista, and Excel are either registered trademarks or trademarks of Microsoft Corporation in the United States and other countries.
- EtherCAT® is registered trademark and patented technology, licensed by Beckhoff Automation GmbH, Germany.
- ODVA, CIP, CompoNet, DeviceNet, and EtherNet/IP are trademarks of ODVA.
- The SD and SDHC logos are trademarks of SD-3C, LLC. 

Other company names and product names in this document are the trademarks or registered trademarks of their respective companies.

## Copyrights

Microsoft product screen shots used with permission from Microsoft.

# **NB-series**

**NB3Q-TW□□B(-V1)**

**NB5Q-TW□□B(-V1)**

**NB7W-TW□□B(-V1)**

**NB10W-TW01B(-V1)**

## **Programmable Terminals**

### **Host Connection Manual**

*Revised September 2023*



# Introduction

---

Thank you for purchasing an NB-series Programmable Terminal.

NB-Series Programmable Terminals (PTs) are designed to handle information generated in FA production sites. Be sure to understand the functions and performances etc thoroughly before using PT correctly.

In this manual, both the NB□□-TW□□B and NB□□-TW□□B-V1 are indicated by the notation of NB□□-TW□□B(-V1). For example, NB3Q-TW01B and NB3Q-TW01B-V1 are indicated as NB3Q-TW01B(-V1).

## Intended Audience

This manual is intended for the following personnel, who must also have knowledge of electrical systems (an electrical engineer or the equivalent).

- Personnel in charge of introducing FA systems into production facilities.
- Personnel in charge of designing FA systems.
- Personnel in charge of installing and connecting FA facilities.
- Personnel in charge of managing FA systems and facilities

## General Precautions

- The user must operate the product according to the performance specifications described in the operation manuals.
- Do not use the PT touch switch input functions for applications where danger to human life or serious property damage is possible, or for emergency switch applications.
- Before using the product under conditions which are not described in the manual or applying the product to nuclear control systems, railroad systems, aviation systems, vehicles, combustion systems, medical equipment, amusement machines, safety equipment, and other systems, machines and equipment that may have a serious influence on lives and property if used improperly, consult your OMRON representative.
- Make sure that the ratings and performance characteristics of the product are sufficient for the systems, machines, and equipment, and be sure to provide the systems, machines, and equipment with double safety mechanisms.
- This manual provides information for connecting and setting up an NB-Series PT. Be sure to read this manual before attempting to use the PT and keep this manual close at hand for reference during installation and operation.

# NB-series Manuals

NB-series manuals are organized in the sections listed in the following tables. Refer to the appropriate section in the manuals as required.

## Programmable Terminals Host Connection Manual (Cat. No. V108) (This Manual)

Section	Contents
<b>Section 1 List for All PLCs Supported by NB series</b>	This section lists all PLCs supported by NB Units.
<b>Section 2 Connecting to SIEMENS PLCs</b>	This section describes the connection to SIEMENS PLCs.
<b>Section 3 Connecting to Mitsubishi PLCs</b>	This section describes the connection to Mitsubishi PLCs.
<b>Section 4 Connecting to Schneider PLCs</b>	This section describes the connection to Schneider PLCs.
<b>Section 5 Modbus Connection</b>	This section describes the connection on Modbus protocol.
<b>Section 6 Connecting to Delta PLCs</b>	This section describes the connection to Delta PLCs.
<b>Section 7 Connecting to LSIS PLCs</b>	This section describes the connection to LSIS PLCs.
<b>Section 8 Connecting to Panasonic Industrial Devices SUNX PLCs</b>	This section describes the connection to Panasonic Industrial Devices SUNX PLCs.
<b>Section 9 Connecting to Allen-Bradley (Rockwell) PLC</b>	This section describes the connection to Allen-Bradley PLC.
<b>Section 10 Connecting to PLC of GE Fanuc Automation Inc.</b>	This section describes the connection to PLC of GE Fanuc Automation Inc.
<b>Section 11 Connecting to Keyence PLCs</b>	This section describes methods to connect to Keyence PLCs.
<b>Section 12 Connecting to OMRON Safety Controller</b>	This section describes the connection to OMRON Safety Controller.

## Programmable Terminals NB-Designer Operation Manual (Cat. No. V106)

Section	Contents
<b>Section 1 Introduction</b>	This section provides an outline of the NB-series PTs, including their functions, features, connection types and communication methods.
<b>Section 2 Installation and Startup of NB-Designer</b>	This section describes how to install and start the NB-Designer.
<b>Section 3 Functions of NB-Designer</b>	This section describes the functions of NB-Designer.
<b>Section 4 Functions of NBManager</b>	This section describes the functions of NBManager.
<b>Section 5 Maintenance and Abnormality Handling</b>	This section describes the maintenance and check to prevent the abnormality occurrence and the handling of the abnormalities occurred in NB Unit.
<b>Section 6 Functions Related to External Memory</b>	This section describes the functions related to external memory.
<b>Section 7 Pictbridge Printing</b>	This section describes the Pictbridge printing function.
<b>Section 8 Web Interface</b>	This section describes the Web Interface function.
<b>Appendices</b>	The appendices provide lists of the NB Units, the Communication Units, the applicable PLCs, the registers supported by PLC, and the list of NB-Designer functions.

## Programmable Terminals Setup Manual (Cat. No. V107)

Section	Contents
<b>Section 1 Part Names and Functions</b>	This section describes the names and functions of the various parts of an NB Unit.
<b>Section 2 Installing the NB Unit and Connecting Peripheral Devices</b>	This section describes the methods used to install the NB Unit and connect peripheral devices.
<b>Section 3 System Setting Mode</b>	This section describes the System Setting Mode.
<b>Section 4 Calibrate Mode</b>	This section describes the Calibrate Mode.
<b>Appendices</b>	The appendices provide information on specifications, dimensions, wirings, and lists of the NB Units, the applicable PLCs and options.

## Programmable Terminals Startup Guide Manual (Cat. No. V109)

Section	Contents
<b>Section 1 NB Overview</b>	This section provide specifications of the NB Unit, describes its names and functions of the various parts.
<b>Section 2 System Design</b>	This section describes the manual structure, takes NB7W as an example to introduce the operation procedures of the NB system.
<b>Section 3 Installation and Wiring</b>	This section describes how to install and wire the NB Unit.
<b>Section 4 Screen Creation</b>	This section describes how to create a demonstration project through NB-Designer.
<b>Section 5 Run</b>	This section describes how to start running at the Host side and prepare to send screen data to NB7W.
<b>Section 6 Maintenance and Troubleshooting</b>	This section describes the maintenance and inspection methods for preventing errors occurring, and troubleshooting measures when errors occur.



### WARNING

Failure to read and understand the information provided in this manual may result in personal injury or death, damage to the product, or product failure. Please read each section in its entirety and be sure you understand the information provided in the section and related sections before attempting any of the procedures or operations given.

# Manual Structure

## Page Structure and Icons

The following page structure and icons are used in this manual.

The diagram shows a page from a manual with the following structure and annotations:

- Level 1 heading:** 2 Installing the NB Unit and Connecting Peripheral Devices
- Level 2 heading:** 2-1 Installing the NB Unit
- Level 3 heading:** 2-1-2 Installation onto the Operation Panel
- Text:** Install the NB Unit by embedding it into the operation panel. Use the metal kit and tool (a crosshead screwdriver) supplied with the Unit for installation. Proceed the installation following the procedures below.
- Step in a procedure:** 1 Panel cutout with dimensions is shown below. Fit the NB Unit into the panel from the front side.
  - Diagram:** Shows a panel cutout with dimensions: Width, Height, and Opening dimensions. An NB Unit is shown being inserted into the cutout.
  - Table:**

Models	Opening Dimension (W×H mm)
NB3Q-TW00B(-V1)/TW01B(-V1)	119.0(+0.5/-0)×93.0(+0.5/-0)
NB5Q-TW00B(-V1)/TW01B(-V1)	172.4(+0.5/-0)×131.0(+0.5/-0)
NB7W-TW00B(-V1)/TW01B(-V1)	191.0(+0.5/-0)×137.0(+0.5/-0)
NB10W-TW01B(-V1)	258.0(+0.5/-0)×200.0(+0.5/-0)
  - Step in a procedure:** 2 As follows, insert panel fixators at the locations indicated by red box around the back of the NB Unit. Insert the hooks of positioners into the square holes on the Unit to hold the fixators properly, and tighten the screws firmly with the screwdriver.
    - Diagram:** Shows the back of the NB Unit with red boxes indicating the locations for panel fixators. An inset diagram shows a panel fixator being inserted into a square hole on the back of the unit.
- Special Information (See below.):** Icons are used to indicate precautions and additional information.
  - Precautions for Safe Use:**
    - When operating on the operation panel, make sure to keep metal particles from entering the Unit.
    - The mounting panel must be between 1.6 and 4.8 mm thick. The NB Unit must be installed in a control panel.
    - For the sake of waterproof and dustproof, all the fixators must be evenly tightened to a torque of 0.5–0.6 Nm. If the tightening torque exceeds the specified value, or the tightening is not even, deformation of the front panel may occur.
    - Make sure that the operation panel is clean, unbent, and strong enough for the installation process.
- Page tab:** 2 - Gives the number of the section.
- Manual name:** NB-series Programmable Terminals Setup Manual(V107)
- Page number:** 2-3

This illustration is provided only as a sample and may not literally appear in this manual.

## Special Information

Special information in this manual is classified as follows:

- Precautions for Safe Use**  
Precautions on what to do and what not to do to ensure using the product safely.
- Precautions for Correct Use**  
Precautions on what to do and what not to do to ensure proper operation and performance.
- Additional Information**  
Additional information to increase understanding or make operation easier.



# Terminology

The following terminology is used in this manual.

Terms	Descriptions
NB Unit	Indicates the main Unit of the products in the OMRON NB Series of Programmable Terminal.
NB Series	Indicates products in the OMRON NB□□ Series of Programmable Terminal. In this manual, unless otherwise specified, NB□□ Series is taken as the subject concerned.
PLC	Indicates a Programmable Controller.
CP Series	Indicates the following products in the OMRON CP Series of Programmable Controllers: CP1H, CP1L, CP1E, CP2E
CS/CJ Series	Indicates the following products in the OMRON CS/CJ Series of Programmable Controllers: CS1G, CS1H, CS1G-H, CS1H-H, CJ1G, CJ1M, CJ2M, CJ2H
NJ/NX Series	Indicates the following OMRON SYSMAC NJ/NX Series of Programmable Controllers: NJ501, NJ301, NJ101, NX102, NX1P2, NX502
C Series	Indicates the following products in the OMRON C Series of Programmable Controllers: C200HX(-Z), C200HG(-Z), C200HE(-Z), CQM1, CQM1H, CPM1A, CPM2A, CPM2C
Serial Communication Unit	Indicates a Serial Communication Unit for an OMRON SYSMAC CS/CJ-Series PLC.
Serial Communication Board	Indicates a Serial Communication Board for an OMRON SYSMAC CS/CJ-Series PLC.
Communication Board	Indicates a Communication Board for an OMRON C200HX/HG/HE(-Z) PLC.
CPU Unit	Indicates a CPU Unit in the OMRON CP, CS/CJ or SYSMAC C Series of Programmable Controllers.
NB-Designer	Indicates the OMRON NB-Designer.
Host	Indicates the PLC and other units functioning as the control devices for NB-Series Units.
PT	Indicates an OMRON Programmable Terminal.



# CONTENTS

---

Introduction.....	1
NB-series Manuals.....	2
Manual Structure .....	4
Terminology .....	5
Terms and Conditions Agreement .....	11
Safety Precautions .....	13
Precautions for Safe Use .....	18
Precautions for Correct Use .....	21
Conformance to EC Directives .....	22
Related Manuals .....	23
<b>Sec. 1 List for All PLCs Supported by NB Series .....</b>	<b>1-1</b>
1-1 Lists for Supported PLC .....	1-2
1-2 Definition and Description of Serial Port COM .....	1-9
<b>Sec. 2 Connecting to SIEMENS PLCs .....</b>	<b>2-1</b>
2-1 <b>Serial Port and Ethernet.....</b>	<b>2-2</b>
2-1-1 Serial Port.....	2-2
2-1-2 Ethernet .....	2-2
2-2 <b>Communication Parameters and Cable Fabrication .....</b>	<b>2-3</b>
2-2-1 Serial Port.....	2-3
2-2-2 Ethernet .....	2-3
2-3 <b>Communication Parameter Setting.....</b>	<b>2-4</b>
2-3-1 When Using SIEMENS S7-200 Communication Protocol .....	2-4
2-3-2 When Using SIEMENS S7-300/400 (PC Adapter Direct) Communication Protocol.....	2-5
2-3-3 SIEMENS S7-200 (SMART) Ethernet (TCP Slave).....	2-8
2-3-4 SIEMENS S7-300 Ethernet (TCP Slave).....	2-17
2-3-5 SIEMENS S7-1200 Ethernet (TCP Slave).....	2-23
2-4 <b>Supported Registers .....</b>	<b>2-27</b>
2-4-1 SIEMENS S7-200 .....	2-27
2-4-2 SIEMENS S7-300/400 (PC Adapter Direct).....	2-28
2-4-3 SIEMENS S7-200 (Smart) Ethernet (TCP Slave).....	2-28
2-4-4 SIEMENS S7-300 Ethernet (TCP Slave).....	2-29
2-4-5 SIEMENS S7-1200 Ethernet (TCP Slave).....	2-30
2-5 <b>Cable Fabrication .....</b>	<b>2-31</b>

**Sec. 3 Connecting to Mitsubishi PLCs ..... 3-1**

<b>3-1</b>	<b>Serial Port and Ethernet.....</b>	<b>3-2</b>
3-1-1	Serial Port .....	3-2
3-1-2	Ethernet.....	3-3
<b>3-2</b>	<b>Communication Setting and Cable Connection .....</b>	<b>3-5</b>
3-2-1	Serial Port .....	3-5
3-2-2	Ethernet.....	3-6
<b>3-3</b>	<b>Communication Setting .....</b>	<b>3-7</b>
3-3-1	When Using Mitsubishi FX1S, Mitsubishi FX1N/2N/3G and Mitsubishi FX3U Communication Protocols .....	3-7
3-3-2	When Using Mitsubishi FX-485ADP/485BD/232BD (Multi-station) Communication Protocols .....	3-9
3-3-3	When Using FX2N-10GM/20GM Communication Protocol .....	3-12
3-3-4	When Using Mitsubishi Q00J (CPU Port) Communication Protocol .....	3-13
3-3-5	When Using Mitsubishi Q series (CPU Port) Communication Protocol .....	3-13
3-3-6	When Using Mitsubishi Q06H Communication Protocol .....	3-14
3-3-7	When Using Mitsubishi Q_QnA (Link Port) Communication Protocol.....	3-15
3-3-8	When Using Mitsubishi FX Series Ethernet(TCP Slave) Communication Protocol .....	3-20
3-3-9	When Using Mitsubishi QnA 3EBin Ethernet (TCP Slave) Communication Protocol .....	3-23
3-3-10	When Using Mitsubishi QJ71E71 EtherNet Slave Communication Protocol .....	3-26
<b>3-4</b>	<b>Supported Registers .....</b>	<b>3-29</b>
<b>3-5</b>	<b>Cable Fabrication .....</b>	<b>3-35</b>

**Sec. 4 Connecting to Schneider PLCs ..... 4-1**

<b>4-1</b>	<b>Serial Port Communication .....</b>	<b>4-2</b>
<b>4-2</b>	<b>Communication Parameters and Cable Fabrication .....</b>	<b>4-3</b>
<b>4-3</b>	<b>Communication Parameter Setting.....</b>	<b>4-4</b>
<b>4-4</b>	<b>Supported Registers .....</b>	<b>4-13</b>
<b>4-5</b>	<b>Cable Fabrication .....</b>	<b>4-14</b>

**Sec. 5 Modbus Connection ..... 5-1**

<b>5-1</b>	<b>Serial Port and Ethernet.....</b>	<b>5-2</b>
<b>5-2</b>	<b>Communication Parameters and Cable Fabrication .....</b>	<b>5-3</b>
<b>5-3</b>	<b>Communication Parameter Setting.....</b>	<b>5-4</b>
<b>5-4</b>	<b>Supported Registers .....</b>	<b>5-7</b>
<b>5-5</b>	<b>Cable Fabrication .....</b>	<b>5-9</b>
<b>5-6</b>	<b>Modbus Protocol .....</b>	<b>5-10</b>
5-6-1	Introduction to Modbus Protocol .....	5-10
5-6-2	When NB adopts Modbus TCP protocol (Master/Slave mode).....	5-11
<b>5-7</b>	<b>Example of NB as Modbus Slave .....</b>	<b>5-12</b>
<b>5-8</b>	<b>Example of connection using Modbus TCP protocol .....</b>	<b>5-15</b>
<b>5-9</b>	<b>Example of E5CC/E5EC, 3G3MX2 connection using Modbus RTU Extend Protocol .....</b>	<b>5-16</b>
<b>5-10</b>	<b>Example of Power PMAC Motion Controller using Modbus TCP Slave Protocol.....</b>	<b>5-18</b>

<b>Sec. 6</b>	<b>Connecting to Delta PLCs .....</b>	<b>6-1</b>
6-1	Serial Port Communication .....	6-2
6-2	Communication Parameters and Cable Fabrication .....	6-3
6-3	Communication Parameter Setting.....	6-4
6-4	Supported Registers .....	6-6
6-5	Cable Fabrication .....	6-7
<b>Sec. 7</b>	<b>Connecting to LSIS PLCs.....</b>	<b>7-1</b>
7-1	Serial Port Communication .....	7-2
7-2	Communication Parameters and Cable Fabrication .....	7-3
7-3	Communication Parameter Setting.....	7-4
7-4	Supported Registers .....	7-12
7-5	Cable Fabrication .....	7-15
<b>Sec. 8</b>	<b>Connecting to Panasonic Industrial Devices SUNX PLCs.....</b>	<b>8-1</b>
8-1	Serial Port Communication .....	8-2
8-2	Communication Parameters and Cable Fabrication .....	8-3
8-3	Communication Parameter Setting.....	8-4
8-4	Supported Registers .....	8-5
8-5	Cable Fabrication .....	8-6
<b>Sec. 9</b>	<b>Connecting to Allen-Bradley (Rockwell) PLC .....</b>	<b>9-1</b>
9-1	Serial Port Communication and Ethernet .....	9-2
9-1-1	Serial Port.....	9-2
9-1-2	Ethernet .....	9-3
9-2	Communication Parameters and Cable Fabrication .....	9-4
9-2-1	Serial Port.....	9-4
9-2-2	Ethernet .....	9-4
9-3	Communication Parameter Setting.....	9-5
9-3-1	When Using AB SLC500/MicroLogix Series (DF1) Protocol .....	9-5
9-3-2	When Using AB CompactLogix/ControlLogix Series (DF1) Protocol.....	9-7
9-3-3	AB MicroLogix Series Ethernet(TCP Slave) .....	9-11
9-4	Supported Registers .....	9-14
9-5	Cable Fabrication .....	9-16
<b>Sec. 10</b>	<b>Connecting to PLC of GE Fanuc Automation Inc. ....</b>	<b>10-1</b>
10-1	Serial Port Communication .....	10-2
10-2	Serial Port Communication Parameters and Cable Fabrication .....	10-3
10-3	Serial Port Communication Parameter Setting.....	10-4
10-4	Supported Registers .....	10-7
10-5	Cable Fabrication .....	10-8

<b>Sec. 11</b>	<b>Connecting to Keyence PLCs .....</b>	<b>11-1</b>
11-1	Serial Port and the Ethernet .....	11-2
11-2	Communication Setting and Cable Connection .....	11-3
11-3	Communication Setting .....	11-4
11-3-1	When Using Keyence KV-3000 Communication Protocol.....	11-4
11-3-2	When Using Keyence KV-5000 EtherNetSlave Communication Protocol .....	11-5
11-4	Supported Registers .....	11-7
11-5	Cable Connection .....	11-8
<b>Sec. 12</b>	<b>Connecting to OMRON Safety Controller .....</b>	<b>12-1</b>
12-1	Serial Port.....	12-2
12-2	Communication Parameters and Cable Fabrication .....	12-3
12-3	Communication Parameter Setting.....	12-4
12-3-1	When using OMRON G9SP Communication Protocol.....	12-4
12-4	Supported Registers .....	12-6
12-5	Cable Connection .....	12-7
	Revision History .....	1

# Terms and Conditions Agreement

## Warranty, Limitations of Liability

### Warranties

#### ● Exclusive Warranty

Omron's exclusive warranty is that the Products will be free from defects in materials and workmanship for a period of twelve months from the date of sale by Omron (or such other period expressed in writing by Omron). Omron disclaims all other warranties, express or implied.

#### ● Limitations

OMRON MAKES NO WARRANTY OR REPRESENTATION, EXPRESS OR IMPLIED, ABOUT NON-INFRINGEMENT, MERCHANTABILITY OR FITNESS FOR A PARTICULAR PURPOSE OF THE PRODUCTS. BUYER ACKNOWLEDGES THAT IT ALONE HAS DETERMINED THAT THE PRODUCTS WILL SUITABLY MEET THE REQUIREMENTS OF THEIR INTENDED USE.

Omron further disclaims all warranties and responsibility of any type for claims or expenses based on infringement by the Products or otherwise of any intellectual property right.

#### ● Buyer Remedy

Omron's sole obligation hereunder shall be, at Omron's election, to (i) replace (in the form originally shipped with Buyer responsible for labor charges for removal or replacement thereof) the non-complying Product, (ii) repair the non-complying Product, or (iii) repay or credit Buyer an amount equal to the purchase price of the non-complying Product; provided that in no event shall Omron be responsible for warranty, repair, indemnity or any other claims or expenses regarding the Products unless Omron's analysis confirms that the Products were properly handled, stored, installed and maintained and not subject to contamination, abuse, misuse or inappropriate modification. Return of any Products by Buyer must be approved in writing by Omron before shipment. Omron Companies shall not be liable for the suitability or unsuitability or the results from the use of Products in combination with any electrical or electronic components, circuits, system assemblies or any other materials or substances or environments. Any advice, recommendations or information given orally or in writing, are not to be construed as an amendment or addition to the above warranty.

See <http://www.omron.com/global/> or contact your Omron representative for published information.

### Limitation on Liability; Etc

OMRON COMPANIES SHALL NOT BE LIABLE FOR SPECIAL, INDIRECT, INCIDENTAL, OR CONSEQUENTIAL DAMAGES, LOSS OF PROFITS OR PRODUCTION OR COMMERCIAL LOSS IN ANY WAY CONNECTED WITH THE PRODUCTS, WHETHER SUCH CLAIM IS BASED IN CONTRACT, WARRANTY, NEGLIGENCE OR STRICT LIABILITY.

Further, in no event shall liability of Omron Companies exceed the individual price of the Product on which liability is asserted.

## Application Considerations

### Suitability of Use

Omron Companies shall not be responsible for conformity with any standards, codes or regulations which apply to the combination of the Product in the Buyer's application or use of the Product. At Buyer's request, Omron will provide applicable third party certification documents identifying ratings and limitations of use which apply to the Product. This information by itself is not sufficient for a complete determination of the suitability of the Product in combination with the end product, machine, system, or other application or use. Buyer shall be solely responsible for determining appropriateness of the particular Product with respect to Buyer's application, product or system. Buyer shall take application responsibility in all cases.

NEVER USE THE PRODUCT FOR AN APPLICATION INVOLVING SERIOUS RISK TO LIFE OR PROPERTY OR IN LARGE QUANTITIES WITHOUT ENSURING THAT THE SYSTEM AS A WHOLE HAS BEEN DESIGNED TO ADDRESS THE RISKS, AND THAT THE OMRON PRODUCT(S) IS PROPERLY RATED AND INSTALLED FOR THE INTENDED USE WITHIN THE OVERALL EQUIPMENT OR SYSTEM.

### Programmable Products

Omron Companies shall not be responsible for the user's programming of a programmable Product, or any consequence thereof.

## Disclaimers

### Performance Data

Data presented in Omron Company websites, catalogs and other materials is provided as a guide for the user in determining suitability and does not constitute a warranty. It may represent the result of Omron's test conditions, and the user must correlate it to actual application requirements. Actual performance is subject to the Omron's Warranty and Limitations of Liability.

### Change in Specifications

Product specifications and accessories may be changed at any time based on improvements and other reasons. It is our practice to change part numbers when published ratings or features are changed, or when significant construction changes are made. However, some specifications of the Product may be changed without any notice. When in doubt, special part numbers may be assigned to fix or establish key specifications for your application. Please consult with your Omron's representative at any time to confirm actual specifications of purchased Product.

### Errors and Omissions

Information presented by Omron Companies has been checked and is believed to be accurate; however, no responsibility is assumed for clerical, typographical or proofreading errors or omissions.





# Safety Precautions

## Notation Used for Safety Information

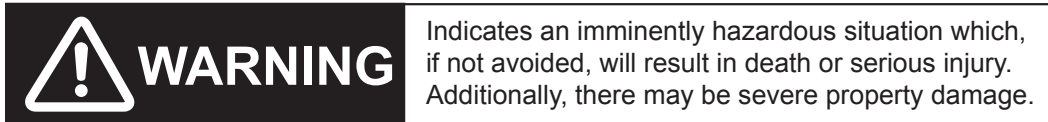
The following notation is used in this manual to provide precautions required to ensure safe usage of the product. The safety precautions that are provided are extremely important to safety. Always read and heed the information provided in all safety precautions.



- 
**Precautions for Safe Use**  
 Indicates precautions on what to do and what not to do to ensure using the product safely.
- 
**Precautions for Correct Use**  
 Indicates precautions on what to do and what not to do to ensure proper operation and performance.
- Note** Indicates suggestive information and precautions on operation of the product.

## Symbols



The circle and slash symbol indicates operations that you must not do.  
 The specific operation is shown in the circle and explained in text.  
 This example indicates prohibiting disassembly.



The triangle symbol indicates precautions (including warnings).  
 The specific operation is shown in the triangle and explained in text.  
 This example indicates a general precaution.



The filled circle symbol indicates operations that you must do.  
 The specific operation is shown in the circle and explained in text.  
 This example shows a general precaution for something that you must do.

 **WARNING**

Do not attempt to take the product apart and do not touch the product inside while the power is being supplied. Otherwise it may result in electric shock.



Always ensure that the personnel in charge confirm that installation, inspection, and maintenance were properly performed for the NB Unit.

“Personnel in charge” refers to individuals qualified and responsible for ensuring safety during machine design, installation, operation, maintenance, and disposal.



Ensure that installation and post-installation checks are performed by personnel in charge who possess a thorough understanding of the machinery to be installed.



Do not use the input functions of the touch switch, etc. of the NB Unit, in applications that involve human life, in applications that may result in serious injury, or for emergency stop switches.



Do not attempt to disassemble, repair, or modify the NB Unit. Otherwise it may impair the safety functions.



Never press at two or more points on the touch panel of the NB Unit at a time. Otherwise, it may activate a switch somewhere between the two points.



## Security Measures

### Anti-virus protection

Install the latest commercial-quality antivirus software on the computer connected to the control system and maintain to keep the software up-to-date.



### Security measures to prevent unauthorized access

Take the following measures to prevent unauthorized access to our products.

- Install physical controls so that only authorized personnel can access control systems and equipment.
- Reduce connections to control systems and equipment via networks to prevent access from untrusted devices.
- Install firewalls to shut down unused communications ports and limit communications hosts and isolate control systems and equipment from the IT network.
- Use a virtual private network (VPN) for remote access to control systems and equipment.
- Adopt multifactor authentication to devices with remote access to control systems and equipment.
- Set strong passwords and change them frequently.
- Scan virus to ensure safety of USB drives or other external storages before connecting them to control systems and equipment.



### Data input and output protection

Validate backups and ranges to cope with unintentional modification of input/output data to control systems and equipment.

- Checking the scope of data
- Checking validity of backups and preparing data for restore in case of falsification and abnormalities
- Safety design, such as emergency shutdown and fail-soft operation in case of data tampering and abnormalities



### Data recovery

Backup data and keep the data up-to-date periodically to prepare for data loss.



When using an intranet environment through a global address, connecting to an unauthorized terminal such as a SCADA, HMI or to an unauthorized server may result in network security issues such as spoofing and tampering.

You must take sufficient measures such as restricting access to the terminal, using a terminal equipped with a secure function, and locking the installation area by yourself.



When constructing an intranet, communication failure may occur due to cable disconnection or the influence of unauthorized network equipment.

Take adequate measures, such as restricting physical access to network devices, by means such as locking the installation area.



When using a device equipped with the SD Memory Card function, there is a security risk that a third party may acquire, alter, or replace the files and data in the removable media by removing the removable media or unmounting the removable media.

Please take sufficient measures, such as restricting physical access to the Controller or taking appropriate management measures for removable media, by means of locking the installation area, entrance management, etc., by yourself.



## Precaution

### Caution

#### Wiring

In the case of the NB Series, when grounding the positive terminal of power supply of 24 V to the NB, do not ground functional grounding terminal at NB side. Some functions of a PC connected to the NB may cause a short circuit and the NB Unit may cause damage.

- Caution:

Depending on the types of PC, SG terminals of RS-232C port or USB port and contour of connector can be connected. As the contour of tool port of the NB and the functional grounding terminal are not insulated, they are connected. Therefore, connecting the PC allows GND terminal and functional grounding terminal of the NB to be connected. If the power supply of 24V to the NB is grounded positively, grounding the functional grounding terminal allows a short circuit as shown in the diagram below and may result in damage.

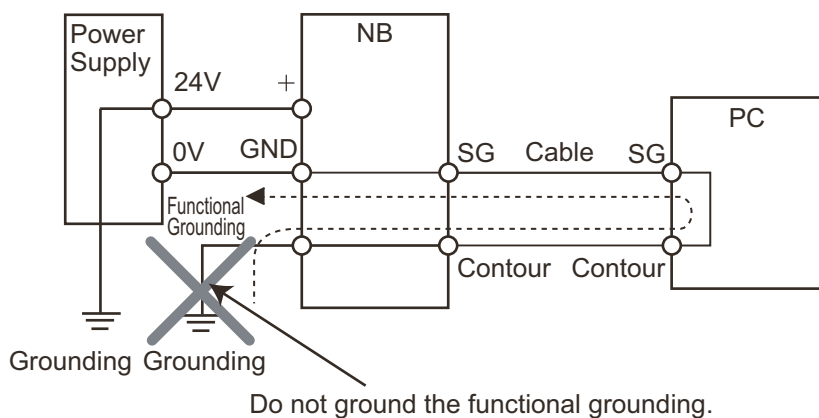

#### Test Function

The Test Function is performed on PC, and it has different behaviors with actual NB running system. A problem may occur due to communication timing, cable differences and unexpected PC circumstances (such as freeze). When the Test Function is performed, please consider possible unexpected circumstances on the actual NB running system and confirm that any dangerous event will not occur beforehand.

# Precautions for Safe Use

---

- When unpacking the NB Units and the peripheral devices, check carefully for any external scratches or other damages. Also, shake the Units gently and check for any abnormal sound.
- The NB Unit must be installed in a control panel.
- The mounting panel must be between 1.6 and 4.8 mm thick. Tighten the Mounting Brackets evenly to a torque of between 0.5 and 0.6 N·m to maintain water and dust resistance. If the tightening torque exceeds the specified value, or the tightening is not even, deformation of the front panel may occur. What is more, make sure the panel is not dirty or warped and that it is strong enough to hold the Units.
- Do not let metal particles enter the Units when preparing the panel.
- Do not connect an AC power supply to the DC power terminals.
- Use a DC power with a slight voltage fluctuation and reinforced or double insulation, and that will provide a stable output even if the input is momentarily interrupted for 10 ms.  
Rated Power Supply Voltage: DC 24 V (Allowable range DC 20.4 ~ 27.6 V)
- Do not perform a dielectric voltage test.
- Before connecting the power supply to the NB unit, mount the cable on the terminal block. Make the connection by using terminal screws crimping on a twisted-pair cable with a crimping range of 12~26 AWG, and only 6.5 mm of insulation peel of the cable needs to be peeled off. Tighten the terminal screws at a torque of between 0.3 and 0.5 N·m. Make sure the screws are properly tightened. Do not use the terminal block of NB3Q-TW□□B(-V1) for other models. NB3Q-TW□□B(-V1) has different pin definitions on the terminal block.
- To prevent malfunctions caused by noise, ground the Unit correctly.
- Do not touch the packaging part of the circuit board with your bare hands. Discharge any static electricity from your body before handling the board.
- When using the No. 6 pin of the serial communication port COM1 connector for a voltage of DC+5V, make sure the supply equipment's current capacity is below 250mA before using it. The DC+5V voltage output of the NB unit is +5V±5%, and the maximum current is 250mA. (The serial communication port COM1 of NB3Q-TW□□B(-V1) is unable to output the current.)
- Turn OFF the power supply before connecting or disconnecting cables.
- Always keep the connector screws firmly tightened after the communication cable is connected.
- Do not pull on the cables or bend the cables beyond their natural limit.  
Do not place heavy objects on top of the cables or other wiring lines. Doing so may break the cables.
- Confirm the safety of the system before turning ON or OFF the power supply, or pressing the reset button.
- The whole system may stop depending on how the power supply is turned ON or OFF. Turn ON/OFF the power supply according to the specified procedure.
- Reset by pressing the reset button, or restart the power supply, once the DIP switch settings are changed.
- To ensure the system's safety, make sure to incorporate a program that can confirm the normal functionality of the NB Unit before running the system.
- Start actual system application only after sufficiently checking screen data, macros and the operation of the program at the host side.
- Do not press the touch panel with a force greater than 30 N.
- Do not use hard or pointed objects to operate or scrub the screen, otherwise, the surface of the screen may be damaged.
- Confirm the safety of the system before pressing the touch panel.
- Signals from the touch switches may not be input if the touch switches are pressed consecutively at high speed. Confirm each input before proceeding to the next one.
- Do not accidentally press the touch panel when the backlight is not lit or when the display does not appear. Make sure of the safety of the system before pressing the touch panel.
- To use numeric input functions safely, always make maximum and minimum limit settings.
- Before initializing screen data, confirm that existing data is backed up at the NB-Designer.

- When changing the password with the screen, do not reset or turn OFF the power supply until writing is finished. Failure to save the password may cause the screen to fail to function.
- When using an equipment monitor, confirm the safety of the system before carrying out the following operations:
  - Changing monitor data.
  - Changing operation mode.
  - Forced set/reset.
  - Changing the current value or the set value.
- Do not connect a USB connector to any device that is not applicable.
- When connecting the equipment with the USB HOST connector, make sure the supply equipment's current capacity is below 150mA before using it. The DC+5V voltage output of the NB Unit is +5V±5%, and the maximum current is 150mA.
- Before connecting a USB connector to a device, make sure that the device is free of damage.
- Commercially available and the recommended USB HUBs are different from the general specifications of the NB Unit. The unit may not function well in an environment subject to noise, static electricity. Therefore, when using a USB HUB, employ sufficient noise and static electricity insulation measures, or install it at a site free of noise or static electricity.
- While uploading or downloading screen data or system programs, do not perform the following operations that may corrupt the screen data or the system program:
  - Turning OFF the power supply of the NB Unit.
  - Pressing the PT's reset switch.
- Dispose of the Units and batteries according to local ordinances as they apply.



- Do not dispose the product into a fire. Doing so may cause the damage with the battery or electronic components.
- Do not apply an impact with the lithium cell, charge it, dispose it into a fire, or heat it. Doing either of them may cause an ignition or a bursting.
- When exporting products with lithium primary batteries containing perchlorate at 6ppb or above to or delivering them through California, USA, the following precautionary measures have to be publicized. Perchlorate material - applicable through special processing. Refer to <http://www.dtsc.ca.gov/hazardouswaste/perchlorate>. NB-Series products contain lithium primary batteries. When exporting products containing this kind of batteries to or delivering them through California, USA, label all the product packages as well as the appropriate delivery packages.
- Do not use benzene, paint thinner, or other volatile solvents, and do not use chemically treated cloths.
- Do not dispose the Units together with general waste at waste yards. When disposing them, follow the related local ordinances or rules.
- Cannot replace the backlight lamp inside the NB Unit.
- Deterioration over time can cause the touch points to move. Calibrate the touch panel periodically.
- Water resistance will be lost if the front sheet is torn or is peeling off. Do not use the Unit, if the front sheet is torn or is peeling off.
- The rubber packing will deteriorate, shrink, or harden depending on the operating environment. Inspect the rubber packing periodically.
- The communication cables of the COM1 and COM2 connectors are not interchangeable. Confirm the pins of the ports before carrying out communications. (NB3Q-TW□□B(-V1) only has COM1.)
- Periodically check the installation conditions in applications where the PT is subject to contact with oil or water.

- Do not perform the following operations during the communication of the USB memory:
  - Turning off the power supply of the NB Unit.
  - Pressing the Reset button on the NB Unit.
  - Removing the USB memory.
- Do not use the USB memory in the environment subject to strong vibration.
- Displaying a pattern for a long time, 24 hours as an indication, may cause an afterimage on the display.  
Enable [Screen Saver] in [PT Extended Property] or switch displaying screens to prevent the afterimage.



# Precautions for Correct Use

---

- Do not install the unit in any of the following locations:
  - Locations subject to severe changes in temperature
  - Locations subject to temperatures or humidity outside the range specified in the specifications
  - Locations subject to condensation as the result of high humidity
  - Locations subject to corrosive or flammable gases
  - Locations subject to strong shock or vibration
  - Locations outdoors subject to direct wind and rain
  - Locations subject to strong ultraviolet light
  - Locations subject to dust
  - Locations subject to direct sunlight
  - Locations subject to splashing oil or chemicals
- Take appropriate and sufficient countermeasures when installing systems in the following locations:
  - Locations subject to static electricity or other forms of noise
  - Locations subject to strong electric field or magnetic field
  - Locations close to power supply lines
  - Locations subject to possible exposure to radioactivity
- Precautions for software:
  - The update, restoration, uninstall and reinstallation of software in running status is prohibited in order to guarantee the correct use of the product.

# Conformance to EC Directives

NB-Series Programmable Terminals are EMC compliant.

## Concepts

OMRON products are electronic devices that are incorporated in machines and manufacturing installations. OMRON PTs conform to the related EMC Directives (see note) so that the devices and machines into which they are built can more easily conform to EMC Directives. The actual products have been through inspections and are completely in accordance with EMC directives. However, when they are built into customers' systems, whether the systems also comply with these Directives is up to the customers for further inspection.

EMC-related performance of OMRON PTs will vary depending on the configuration, wiring, and other conditions of the OMRON equipment or control panel. The customer must, therefore, perform final checks to confirm that the overall machine or device conforms to EMC standards.

**Note** The applicable EMC (Electromagnetic Compatibility) standards are as follows:

EMS (Electromagnetic sensitivity): EN61131-2: 2007

EMI (Electromagnetic Interference): EN61131-2: 2007

## Conformance to EC Directives

NB-Series Programmable Terminals are EC compliant. Heed the following precautions in order to ensure that the customer's overall machine and device conform to EC Directives.

- 1** The PT must be installed in a control panel.
- 2** You must use reinforced insulation or double insulation for the DC power supply and the DC power supply must have minimal voltage fluctuations and provide a stable output even if the power supply input is interrupted for 10 ms.
- 3** The PTs conform to the standard EN 61131-2, but radiated emission characteristics (10m regulations) may vary depending on the configuration of the control panel used, other devices connected to the control panel, wiring, and other conditions. You must therefore confirm that the overall machine or equipment complies with EC Directives.
- 4** This is a Class A product (Product for industry purpose). It may cause radio interference in residential areas, in which case the user may be required to take adequate measures to reduce interference.

## Conformance to KC Standards

Observe the following precaution if you use NB-series Programmable Terminals in Korea.

**A 급 기기 (업무용 방송통신기자재)**

이 기기는 업무용(A 급) 전자파적합기기로서 판매자 또는 사용자는 이 점을 주의하시기 바라며, 가정외의 지역에서 사용하는 것을 목적으로 합니다.

Class A Device (Broadcasting Communications Device for Office Use)

This device obtained EMC registration for office use (Class A), and it is intended to be used in places other than homes.

Sellers and/or users need to take note of this.

# Related Manuals

The related manuals are as follows:

Devices and Software	Manual Name	Manual No.
NB series	NB Series NB-Designer Operation Manual	V106
	NB Series Setup Manual	V107
	NB Series Host Connection Manual (This manual)	V108
	NB Series Startup Guide	V109
PLC	SYSMAC CP Series CP1L CPU Unit Operation Manual	W462
	SYSMAC CP Series CP1H/L CPU Unit Programming Manual	W451
	SYSMAC CP Series CP1H CPU Unit Operation Manual	W450
	SYSMAC CP Series CP1E CPU Unit Hardware User's Manual	W479
	SYSMAC CP Series CP1E CPU Unit Software User's Manual	W480
	SYSMAC CP Series CP1E/CP2E CPU Unit Instructions Reference Manual	W483
	SYSMAC CP Series CP1L-EL/EM CPU Unit Operation Manual	W516
	SYSMAC CP Series CP2E CPU Unit Hardware User's Manual	W613
	SYSMAC CP Series CP2E CPU Unit Software User's Manual	W614
	SYSMAC C200HX/HG/HE(-E/-ZE) Installation Guide	W302
	SYSMAC C200HX/HG/HE Operation Manual	W303
	SYSMAC C200HX/HG/HE(-ZE) Operation Manual	W322
	SYSMAC CPM1A Operation Manual	W317
	SYSMAC CPM2A Operation Manual	W352
	SYSMAC CPM1/CPM1A/CPM2A/CPM2C/SRM1(-V2) Programming Manual	W353
	SYSMAC CPM2C Operation Manual	W356
	SYSMAC CS1 Series CS1G/H Operation Manual	W339
	SYSMAC CS/CJ Series Serial Communications Boards and Serial Communications Units Operation Manual	W336
	SYSMAC CJ Series CJ1G/H(-H) CJ1M CJ1G Operation Manual	W393
	SYSMAC CS/CJ Series Programming Manual	W394
	SYSMAC CS/CJ Series Instructions Reference Manual	W340
	SYSMAC CS/CJ Series Programming Consoles Operation Manual	W341
	SYSMAC CS/CJ Series Communications Commands Reference Manual	W342
	SYSMAC CJ Series CJ2 CPU Unit Hardware User's Manual	W472
	SYSMAC CJ Series CJ2 CPU Unit Software User's Manual	W473
	SYSMAC CS/CJ Series CS1W/CJ1W-ETN21 (100Base-TX) Ethernet Units Operation Manual Construction of Networks	W420
	SYSMAC CS/CJ Series CS1W/CJ1W-ETN21 (100Base-TX) Ethernet Units Operation Manual Construction of Applications	W421
	SYSMAC CS and CJ Series EtherNet/IP™ Units Operation Manual	W465
	NJ Series CPU Unit Hardware User's Manual	W500
	NJ/NX Series CPU Unit Software User's Manual	W501
	NJ/NX Series CPU Unit Built-in EtherNet/IP™ Port User's Manual	W506

Devices and Software	Manual Name	Manual No.
PLC	NJ/NX Series Troubleshooting Manual	W503
	NX-Series NX102 CPU Unit Hardware User's Manual	W593
	NX-Series NX1P2 CPU Unit Hardware User's Manual	W578
	NX-Series NX1P2 CPU Unit Built-in I/O and Option Board User's Manual	W579
	NX-Series NX502 CPU Unit Hardware User's Manual	W629
Safety Controller	G9SP Series Safety Controller Operation Manual	Z922
External Tool	CX-Programmer Ver.9.□ Operation Manual	W446
	Sysmac Studio Version 1 Operation Manual	W504

# 1

## List for All PLCs Supported by NB Series

---

This section lists all PLCs supported by NB Series.

---

<b>1-1</b>	<b>Lists for Supported PLC</b> .....	<b>1-2</b>
<b>1-2</b>	<b>Definition and Description of Serial Port COM</b> .....	<b>1-9</b>

# 1-1 Lists for Supported PLC

## ● NB□□-TW□□B

Names Displayed in NB-Designer	PLC Models	PLC Manufacturers
AB CompactLogix/ControlLogix Series(DF1)	CompactLogix 1769-L20	Rockwell Automation, Inc.
	CompactLogix 1769-L30	
	CompactLogix 1769-L31	
	CompactLogix 1769-L32E	
	CompactLogix 1769-L35E	
	ControlLogix 1756-L61	
	ControlLogix 1756-L63	
AB SLC500/MicroLogix Series(DF1)	MicroLogix 1000	
	MicroLogix 1200	
	MicroLogix 1400 1766-L32BWAA	
	MicroLogix 1500 1764-LRP	
	MicroLogix 1500 1764-LSP	
	SLC 5/03	
	SLC 5/04	
	SLC 5/05	
AB MicroLogix Series Ethernet (TCP Slave)	MicroLogix 1100	
	MicroLogix 1400	
	1761-NET-ENI communication module	
Delta DVP	DVP-xxES/EX/SS	Delta
	DVP-xxSA/SX/SC	
	DVP-xxEH/EH2/SV	
GE Fanuc Series SNP	IC693CPU311/313	GE
	IC693CPU321/323	
	IC693CPU331/340/341	
	IC693CPU350/351/352	
	IC693CPU360/363/364/374	
	IC693CSE311	
	IC693CSE313	
	IC693CSE323	
	IC693CSE331	
	IC693CSE340	
GE SNP-X	IC693CPU311/313/321/323	
	IC693CPU331/340/341	
	IC693CPU350/351/352	
	IC693CPU360/363/364/374	
	CPU001/002/005	
	CPUE05	
	IC200UAL004/005/006	
	IC200UDD110/120/212	
	IC200UDR005/006/010	
	IC200UAA007	
	IC200UAR028	
	IC693CMM311	

Names Displayed in NB-Designer	PLC Models	PLC Manufacturers	
LS Master-K Cnet	K120s	LSIS	
	K200s		
LS Master-K CPU Direct	K120s		
	K200s		
LS Master-K Modbus RTU	K120s		
	K200s		
LS XGT CPU Direct	XGT		
	XGB		
LS XGT Cnet	XBC-DN64H		
	XBC-DR32H		
Mitsubishi FX Series Ethernet (TCP Slave)	FX3U-ENET-L		Mitsubishi
Mitsubishi FX1N/2N/3G	FX1N		
	FX2N		
	FX3G		
	FX1NC		
	FX2NC		
Mitsubishi FX1S	FX1S		
Mitsubishi FX2N-10GM/20GM	FX2N_10GM		
	FX2N_20GM		
Mitsubishi FX3U	FX3S		
	FX3U		
	FX3UC		
Mitsubishi FX-485ADP/485BD/232BD (Multi-station)	FX-485ADP/485BD/232BD		
Mitsubishi Q Series (CPU Port)	Q02 CPU		
	Q02H CPU		
	Q12H CPU		
	Q25H CPU		
	Q06UDHCPU		
Mitsubishi Q_QnA (Link Port)	Q00 CPU		
	Q00UJ CPU		
	Q01 CPU		
	QJ71C24 module		
	QJ71C24-R2 module		
	QJ71C24N module		
	QJ71C24N-R2 module		
	QJ71C24N-R4 module		
	L02S CPU		
	LJ71C24 module		
	LJ71C24-R2 module		
Mitsubishi Q00J (CPU Port)	Q00J		
Mitsubishi Q06H	Q06H CPU		

# 1 List for All PLCs Supported by NB Series

Names Displayed in NB-Designer	PLC Models	PLC Manufacturers
Mitsubishi QnA 3Ebin Ethernet (TCP Slave)	Q03UDE	Mitsubishi
	Q04UDEH	
	Q06UDEH	
	Q10UDEH	
	Q13UDEH	
	Q20UDEH	
	Q26UDEH	
	Q50UDEH	
	Q100UDEH	
	Q03UDV	
	Q04UDV	
	Q06UDV	
	Q13UDV	
	Q26UDV	
	L02CPU	
	L02CPU-P	
	L06CPU	
	L06CPU-P	
	L26CPU	
L26CPU-P		
L26CPU-BT		
L26CPU-PBT		
Mitsubishi QJ71E71 EtherNet Slave	QJ71E71-100 module	
	LJ71E71-100 module	
Modbus ASCII	Modbus Compatible External Device	Modbus
Modbus RTU	Modbus Compatible External Device	
Modbus RTU Modicon_BE	Modbus Compatible External Device	
Modbus RTU Extend	Modbus Compatible External Device	
Modbus RTU Slave	Modbus Compatible External Device	
Modbus TCP Slave	Modbus Compatible External Device	



Names Displayed in NB-Designer	PLC Models	PLC Manufacturers
Omron C Series	C200HX/HG/HE(-Z)	Omron
	CQM1H	
	CPM1□/2□	
Omron CJ/CS/NJ Series	CS1W-SCU21/31	
	CS1W-SCB21/41	
	CS1□	
	CJ1W-SCU21/22/31/32/41/42	
	CJ1□	
	CJ2□	
	NJ□01	
Omron CP Series	CP1H/L/E	
	CP2W-CIFD	
	CP2E	
Omron NX1 Series Host Link	NX1P2-□□□□	
Omron CJ/CS/NJ Series Ethernet (UDP Slave)	CS1W-ETN21/EIP21/EIP21S	
	CJ1W-ETN21/EIP21/EIP21S	
	CJ2H-□□□-EIP	
	CJ2M-CPU3□	
	NJ□01-□□□□	
Omron NX Series Ethernet (UDP Slave)	NX102-□□□□	
	NX1P2-□□□□	
Omron CP Series Ethernet (UDP Slave)	CP1L-EM	
	CP1L-EL	
	CP1W-CIF41	
	CP1H	
	CP1L	
	CP2E	
OMRON G9SP	G9SP-N10S	
	G9SP-N10D	
	G9SP-N20S	
Panasonic FP	FP0/FP1/FP2/FP3	Panasonic Industrial Devices SUNX
	FP2SH	
	FP10SH/FP10S	
	FP-M	
	FP-e	
	FP-X	
Schneider Modicon Uni-TelWay	Micro Series	Schneider
	Premium Series	
	Nano Series	
Schneider Twido Modbus RTU	TWD LCAA 10DRF	
	TWD LCAA 16DRF	
	TWD LCAA 24DRF	
	TWD LMDA 20DTK	
	TWD LMDA 20DUK	
	TWD LMDA 20DRT	
	TWD LMDA 40DTK	
	TWD LMDA 40DUK	

# 1 List for All PLCs Supported by NB Series

Names Displayed in NB-Designer	PLC Models	PLC Manufacturers
Siemens S7-200	CPU212/214/215/216	Siemens
	CPU221/222/224/226	
	CPU224 XP CN	
	CPU226 XP CN	
SIEMENS S7-200 (Smart) Ethernet (TCP Slave)	CPU CR40	
	CPU SR20	
	CP 243-1 communication module	
	CP 243-1 IT communication module	
SIEMENS S7-300/400 (PC Adapter Direct)	CPU312IFM/CPU313/CPU313C	
	CPU314IFM/CPU314	
	CPU315/CPU315-2 DP	
	CPU316/CPU316-2 DP	
	CPU318-2	
	CPU412-1/CPU412-2 DP	
	CPU413-1/CPU413-2 DP	
	CPU414-1/CPU414-2 DP/CPU414-3 DP	
	CPU416-1/CPU416-2 DP/CPU416-3 DP	
	CPU417-4	
SIEMENS S7-300 Ethernet (TCP Slave)	CPU315-2 PN/DP	
	CPU317-2 PN/DP	
	CPU319-3 PN/DP	
	CP 343-1 communication module	
	CP 343-1 IT communication module	
SIEMENS S7-1200 Ethernet (TCP Slave)	CPU1211C	
	CPU1214C	
Keyence KV-3000	KV-3000	Keyence
Keyence KV-5000 EtherNet Slave	KV-5000	

## ● NB□□-TW□□B-V1

Names Displayed in NB-Designer	PLC Models	PLC Manufacturers
Omron C Series	C200HX/HG/HE(-Z)	Omron
	CQM1H	
Omron CJ/CS/NJ Series	CS1W-SCU21/31	
	CS1W-SCB21/41	
	CS1□	
	CJ1W-SCU22/32/42	
	CJ2□	
	NJ□01	
Omron CP Series	CP1H/L/E	
	CP2W-CIFD01/02/03	
	CP2E	
Omron NX1 Series Host Link	NX1P2-□□□□	
Omron CJ/CS/NJ Series Ethernet (UDP Slave)	CS1W-ETN21/EIP21/EIP21S	
	CJ1W-ETN21/EIP21/EIP21S	
	CJ2H-□□□-EIP	
	CJ2M-CPU3□	
	NJ□01-□□□□	
Omron NX Series Ethernet (UDP Slave)	NX102-□□□□	
	NX1P2-□□□□	
	NX502-□□□□	
Omron CP Series Ethernet (UDP Slave)	CP1L-EM	
	CP1L-EL	
	CP1H-EX	
	CP1W-CIF41 (Mount on CP1)	
	CP2E	
OMRON G9SP	G9SP-N10S	
	G9SP-N10D	
	G9SP-N20S	
Modbus ASCII	Modbus Compatible External Device	Modbus
Modbus RTU Extend	Modbus Compatible External Device	
Modbus RTU Slave	Modbus Compatible External Device	
Modbus TCP Slave	Modbus Compatible External Device	
Mitsubishi QnA 3Ebin Ethernet (TCP Slave)	Q03UDE	Mitsubishi
	Q04UDEH	
	Q06UDEH	
	Q10UDEH	
	Q13UDEH	
	Q20UDEH	
	Q26UDEH	
	Q50UDEH	
	Q100UDEH	
	Q04UDV	
	L06CPU	
	L26CPU	

# 1 List for All PLCs Supported by NB Series

Names Displayed in NB-Designer	PLC Models	PLC Manufacturers
Panasonic FP	FP0/FP1/FP2/FP3	Panasonic Industrial Devices SUNX
	FP2SH	
	FP10SH/FP10S	
	FP-M	
	FP-e	
	FP-X	
SIEMENS S7-200 (Smart) Ethernet (TCP Slave)	CPU CR40	Siemens
	CPU SR20	
	CP 243-1 communication module	
	CP 243-1 IT communication module	
	CPU ST40	
	CPU222/CPU224/CPU226	
	CPU224 XP CN	
	CPU226 XP CN	
SIEMENS S7-300 Ethernet (TCP Slave)	CPU315-2 PN/DP	
	CPU317-2 PN/DP	
	CPU319-3 PN/DP	
	CP 343-1 communication module	
	CP 343-1 IT communication module	
SIEMENS S7-1200 Ethernet (TCP Slave)	CPU1211C	
	CPU1214C	
	CPU1217C	

# 1-2 Definition and Description of Serial Port COM

## ● Serial Port COM1

- NB5Q/NB7W/NB10W-TW□□B(-V1)

Serial port COM1 is a 9-pin D-type socket port. This port supports RS-232C communication function, making it connectable to a controller which features RS-232C function, and it can also be used for downloading programs or debugging for the product.

The pins are defined as follows:



NB5Q/NB7W/NB10W-TW□□B(-V1)	
Pins	COM1 Signals
1	NC
2	SD
3	RD
4	RS(RTS)*
5	CS(CTS)*
6	DC+5V
7	NC
8	NC
9	SG

\* Pin 4 and 5 are not used, thus not compliant with RS or CS function.



### Precautions for Safe Use

When using the No. 6 pin of the serial communications port COM1 connector for a voltage of DC+5V, make sure the supply equipment's current capacity is below 250 mA before using it. The DC+5V voltage output of the NB Unit is +5V±5%, and the maximum current is 250 mA.

- NB3Q-TW□□B(-V1)

NB3Q-TW□□B(-V1) has only 1 serial port COM1, and this port supports communication (non-isolated) based on RS-232C, RS-422 and RS-485, of which only 1 connection mode can be applied at one time. By means of the RS-232C mode (PIN 2~5), it can be connected to a controller based on RS-232C, and can also be used for downloading programs, as well as debugging for the product (connected to a PC). While with the RS-422 or the RS-485 mode (PIN 1, PIN 6~8), only a PLC can be connected.

The pins are defined as follows:



Pins	Signals	I/O	Functions		
			RS-232C	RS-485	RS-422A
1	SDB+	I/O	-	-	Sending data(+)
2	SD	O	Sending data	-	-
3	RD	I	Receiving data	-	-
4	RS(RTS)	O	Request to send*	-	-
5	CS(CTS)	I	Clear to send*	-	-
6	RDB+	I/O	-	RS485B Send/Receive data(+)	Receiving data(+)
7	SDA-	I/O	-	-	Sending data(-)
8	RDA-	I/O	-	RS485A Send/Receive data(-)	Receiving data(-)
9	SG	-	Signal ground		

\* Pin 4 and 5 are not used, thus not compliant with RS or CS function.

- **Precaution for Cable Fabrication**

The COM 2 ports included in this manual and marked by cable manufacturers are intended for the PT of NB5Q/NB7W/NB10W-TW□□B(-V1) models, therefore when communication connection is carried out with the COM 1 port of NB3Q-TW□□B(-V1), please refer to the pin definitions in this section prior to connection.

- **Serial Port COM2**

- NB5Q/NB7W/NB10W-TW□□B(-V1)

Serial port COM2 is a 9-pin D-type socket port. This port supports RS-232C/RS-485/RS-422A communication function.

The pins are defined as follows:



Pins	Signals	I/O	Functions		
			RS-232C	RS-485	RS-422A
1	SDB+	I/O	-	-	Sending data(+)
2	SD	O	Sending data	-	-
3	RD	I	Receiving data	-	-
4	Terminal R1	-	-	Terminal resistor	
5	Terminal R2	-	-	Terminal resistor	
6	RDB+	I/O	-	Send/Receive data(+)	Receiving data(+)
7	SDA-	I/O	-	-	Sending data(-)
8	RDA-	I/O	-	Send/Receive data(-)	Receiving data(-)
9	SG	-	Signal ground		

# 2

## Connecting to SIEMENS PLCs

This section describes the connection to SIEMENS PLCs.

NB□□-TW□□B and NB□□-TW□□B-V1 support different PLC models, please refer to *Section 1* for details.

---

<b>2-1</b>	<b>Serial Port and Ethernet</b> .....	<b>2-2</b>
2-1-1	Serial Port .....	2-2
2-1-2	Ethernet .....	2-2
<b>2-2</b>	<b>Communication Parameters and Cable Fabrication</b> .....	<b>2-3</b>
2-2-1	Serial Port .....	2-3
2-2-2	Ethernet .....	2-3
<b>2-3</b>	<b>Communication Parameter Setting</b> .....	<b>2-4</b>
2-3-1	When Using SIEMENS S7-200 Communication Protocol .....	2-4
2-3-2	When Using SIEMENS S7-300/400 (PC Adapter Direct) Communication Protocol .....	2-5
2-3-3	SIEMENS S7-200 (SMART) Ethernet (TCP Slave) .....	2-8
2-3-4	SIEMENS S7-300 Ethernet (TCP Slave) .....	2-17
2-3-5	SIEMENS S7-1200 Ethernet (TCP Slave) .....	2-23
<b>2-4</b>	<b>Supported Registers</b> .....	<b>2-27</b>
2-4-1	SIEMENS S7-200 .....	2-27
2-4-2	SIEMENS S7-300/400 (PC Adapter Direct) .....	2-28
2-4-3	SIEMENS S7-200 (Smart) Ethernet (TCP Slave) .....	2-28
2-4-4	SIEMENS S7-300 Ethernet (TCP Slave) .....	2-29
2-4-5	SIEMENS S7-1200 Ethernet (TCP Slave) .....	2-30
<b>2-5</b>	<b>Cable Fabrication</b> .....	<b>2-31</b>

## 2-1 Serial Port and Ethernet

### 2-1-1 Serial Port

Series	CPU	Link Module	Driver
<b>S7-200</b>	CPU212 CPU214 CPU215 CPU216 CPU221 CPU222 CPU224 CPU226 CPU224 XP CN CPU226 XP CN	RS485 on the CPU unit	SIEMENS S7-200
<b>S7-300</b>	CPU312IFM CPU313 CPU313C CPU314 CPU314IFM CPU315 CPU315-2 DP CPU316 CPU316-2 DP CPU318-2	MPI port on the CPU unit	SIEMENS S7-300/400 (PC Adapter Direct)
<b>S7-400</b>	CPU412-1 CPU412-2 DP CPU413-1 CPU413-2 DP CPU414-1 CPU414-2 DP CPU414-3 DP CPU416-1 CPU416-2 DP CPU416-3 DP CPU417-4	MPI port on the CPU unit	

### 2-1-2 Ethernet

Series	CPU	Link Module	Driver
<b>S7-200</b>	CPU222 CPU224 CPU226 CPU224 XP CN CPU226 XP CN	CP 243-1 CP 243-1 IT	SIEMENS S7-200 (Smart) Ethernet (TCP Slave)
<b>S7-200 SMART</b>	CR40 SR20 ST40	Ethernet interface on CPU	
<b>S7-300</b>	CPU315-2DP CPU315-2 PN/DP CPU317-2 PN/DP CPU319-3 PN/DP	CP 343-1 CP 343-1 IT Ethernet interface on CPU	SIEMENS S7-300 Ethernet (TCP Slave)
<b>S7-1200</b>	CPU1211C CPU1214C CPU1217C	Ethernet interface on CPU	SIEMENS S7-1200 Ethernet (TCP Slave)



## 2-2 Communication Parameters and Cable Fabrication

### 2-2-1 Serial Port

Series	CPU	Link Module	COMM Type	Parameter	Cable
S7-200	CPU222 CPU224 CPU226 CPU224 XP CN CPU226 XP CN	RS485 on the CPU unit	RS232	Refer to Section 2-3	Self-made cable required
	RS485				
S7-300	CPU312IFM CPU313 CPU313C CPU314 CPU314IFM CPU315 CPU315-2 DP CPU316 CPU316-2 DP CPU318-2	MPI port on the CPU unit	RS232 S7-300/400 (PC Adapter Direct) protocol		
	CPU412-1 CPU412-2 DP CPU412-3H CPU413-1 CPU413-2 DP CPU414-1 CPU414-2 DP CPU414-3 DP CPU416-1 CPU416-2 DP CPU416-3 DP CPU417-4		RS232 S7-300/400 (PC Adapter Direct) protocol		

### 2-2-2 Ethernet

Series	CPU	Link Module	COMM Type	Parameter	Cable
S7-200	CPU222 CPU224 CPU226 CPU224 XP CN CPU226 XP CN	CP 243-1 CP 243-1 IT	-	Refer to Section 2-3	Network Cable
	CR40 SR20 ST40	Ethernet Port of CPU Unit	-		
S7-300	CPU315-2DP	CP 343-1 CP 343-1 IT	-		
	CPU315-2 PN/DP CPU317-2 PN/DP CPU319-3 PN/DP	Ethernet Port of CPU Unit	-		
S7-1200	CPU1211C CPU1214C CPU1217C	Ethernet Port of CPU Unit	-		

## 2-3 Communication Parameter Setting

### 2-3-1 When Using SIEMENS S7-200 Communication Protocol

#### PT Settings

PT default communication parameters: 9600bps (Baud Rate), 8 (Data Bit), 1 (Stop Bit), even(Parity Check) and 2 (PLC Station No.)

**Note** The maximum communication baud rate is 187.5K that is not supported by the direct online.  
The PLC No. should match with the PLC No. in PT. Because the PLC address of S7-200 ranges from 1 to 126, so the PLC No. in PT should also range from 1 to 126.

RS485 Communication

The screenshot shows the 'HMI Attribute' dialog box with the 'COM2 Setting' tab selected. The 'Type' is set to 'RS485'. The communication parameters are: Baud Rate: 9600, Data Bit: 8, Parity Check: even, Stop Bit: 1, and Broadcast: 65535 (unchecked). The communication time-out settings are: PLC Communication Time Out: 3, Protocol Time Out 1(ms): 50, Protocol Time Out 2(ms): 0, Max interval of word block pack: 4, Max interval of bit block pack: 8, Max size of word block package: 16, and Max size of bit block package: 64. A 'Use Default Setting' button is at the bottom.

Parameter	Value
Type	RS485
Baud Rate	9600
Data Bit	8
Parity Check	even
Stop Bit	1
Broadcast	65535
PLC Communication Time Out	3
Protocol Time Out 1(ms)	50
Protocol Time Out 2(ms)	0
Max interval of word block pack	4
Max interval of bit block pack	8
Max size of word block package	16
Max size of bit block package	64

RS232 Communication

The screenshot shows the 'HMI Attribute' dialog box with the 'COM2 Setting' tab selected. The 'Type' is set to 'RS232'. The communication parameters are: Baud Rate: 9600, Data Bit: 8, Parity Check: even, Stop Bit: 1, and Broadcast: 65535 (unchecked). The communication time-out settings are: PLC Communication Time Out: 3, Protocol Time Out 1(ms): 50, Protocol Time Out 2(ms): 0, Max interval of word block pack: 4, Max interval of bit block pack: 8, Max size of word block package: 16, and Max size of bit block package: 64. A 'Use Default Setting' button is at the bottom.

Parameter	Value
Type	RS232
Baud Rate	9600
Data Bit	8
Parity Check	even
Stop Bit	1
Broadcast	65535
PLC Communication Time Out	3
Protocol Time Out 1(ms)	50
Protocol Time Out 2(ms)	0
Max interval of word block pack	4
Max interval of bit block pack	8
Max size of word block package	16
Max size of bit block package	64

## PLC Settings

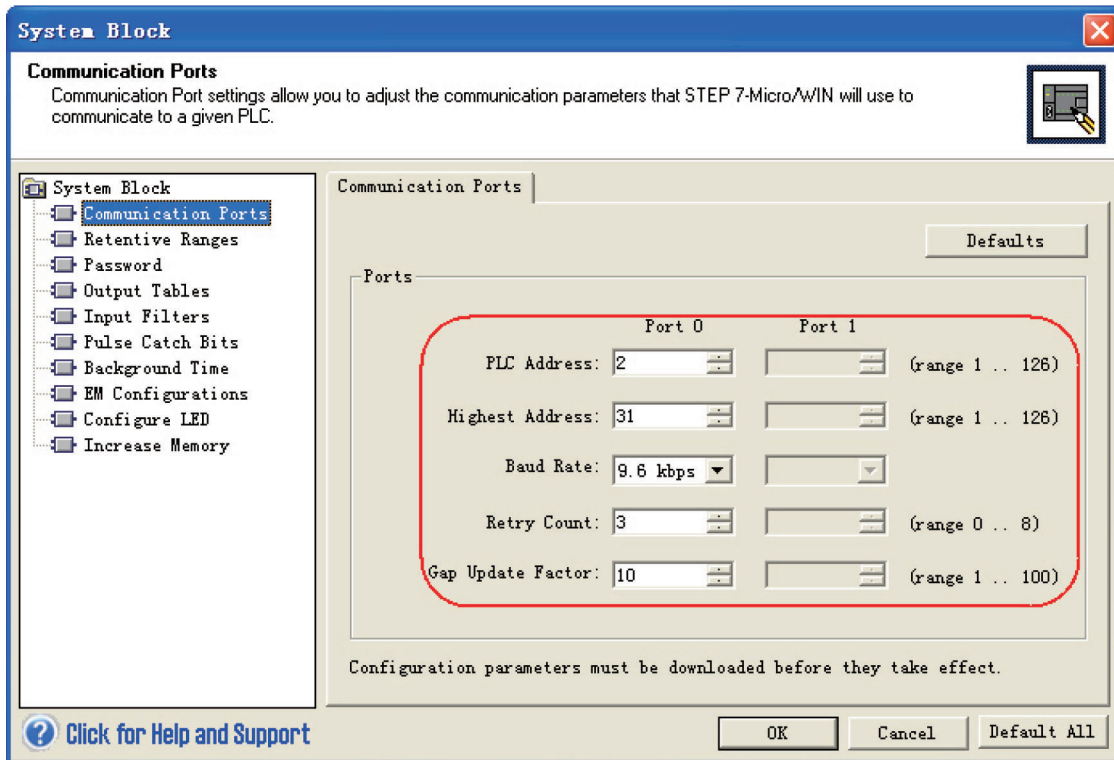

### 2-3-2 When Using SIEMENS S7-300/400 (PC Adapter Direct) Communication Protocol

## PT Settings

PT default communication parameters: 19200bps(Baud Rate), 8(Data Bit), 2(Stop Bit), odd (Parity Check) and 2 (PLC Station No.) (Multiple Station No. is not supported.)

RS232 Communication

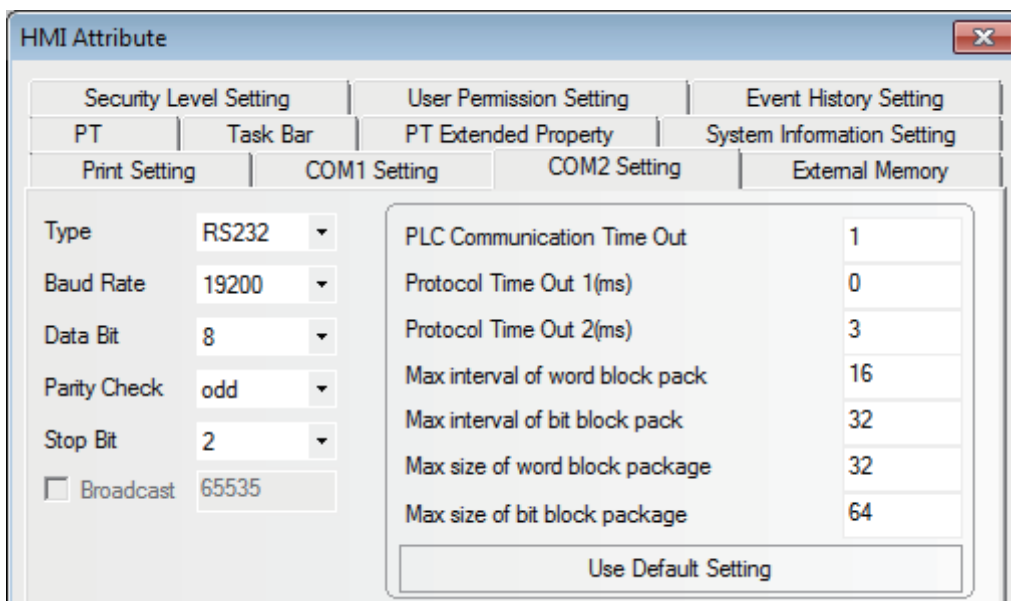

- Note 1** The PLC Station No. is not needed if the PC adapter is used, which realize one for one communication.
- 2** When MPI-Adapter SSW7, RS232 (Order No.700-751-1VK21) manufactured by Helmholz is used, set the communication speed as follows. Also the firmware of the MPI-Adapter should be V3.4b7 or later.
- PLC communication speed: 19.2/187.5 kbps
  - PT communication speed: 9600/14400/19200/38400/56000/57600/115200 bps
- 3** DB blocks should be established in PLC program configuration, otherwise the relevant registers (DB.DBX, DB.DBW, DB.DBD) can not be written. The even parity should be used on the initial addresses of DBm.DBW and DBm.DBD.
- Note** For information of the product manufactured by Helmholz, please access to website as follows.  
 Systeme Helmholz GmbH  
<http://www.helmholz.de/>  
 If the firmware version of the purchased MPI-Adapter is old, please download SHTools from website as above to update the firmware.

## PLC Settings

- 1** When MPI-Adapter manufactured by Helmholz is used, set the communication speed of PLC to 19.2 Kbps or 187.5 Kbps.

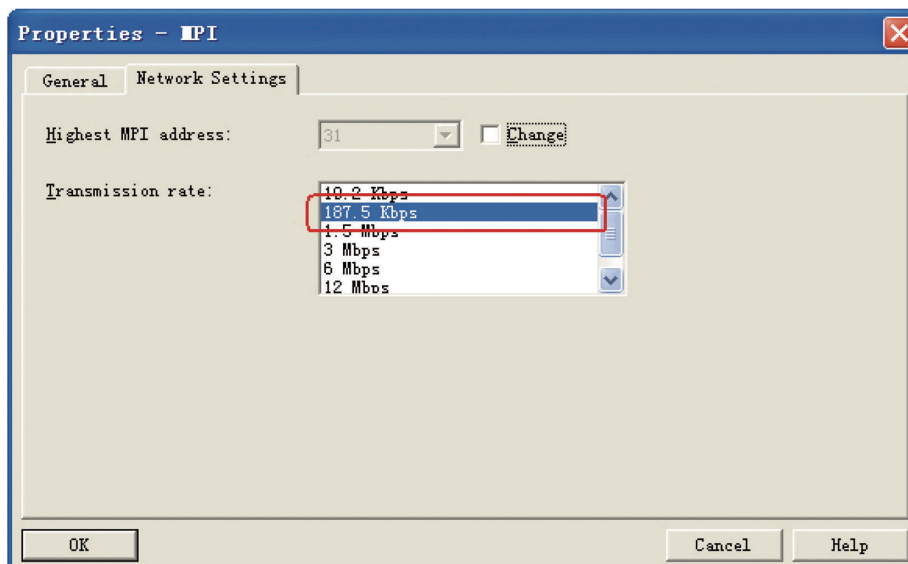

- 2** The MPI address must be 2.

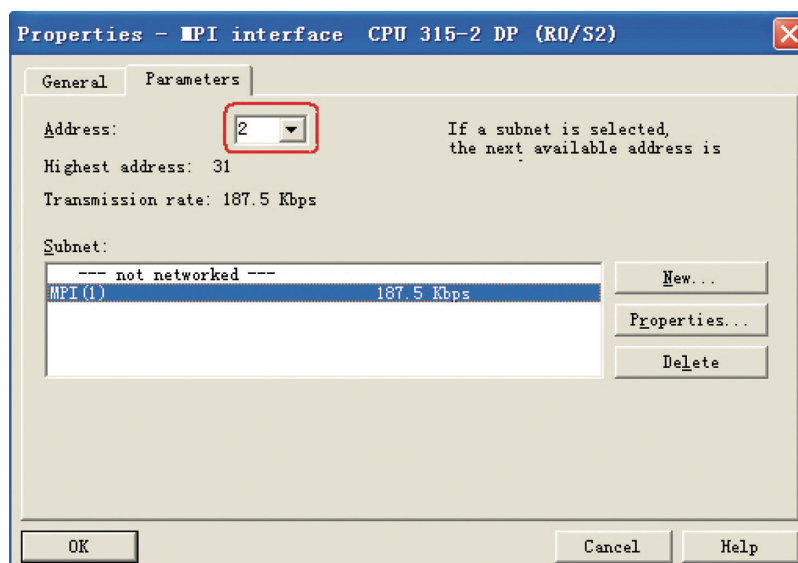

- 3** Download the set parameters to PLC after the setting is completed. Then open [SIMATIC Manager] menu-[Option]-[PG/PC Interface Setting], select PC Adapter (MPI) and modify the transmission rate of MPI port to be 187.5K, as shown below:

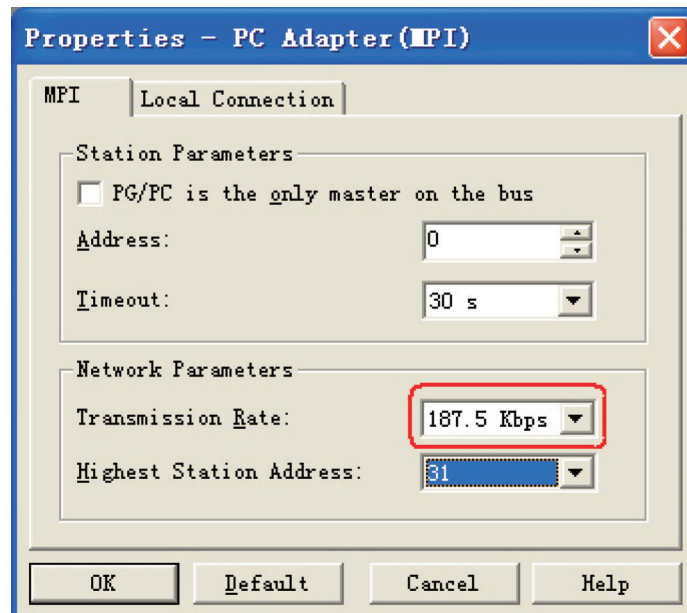
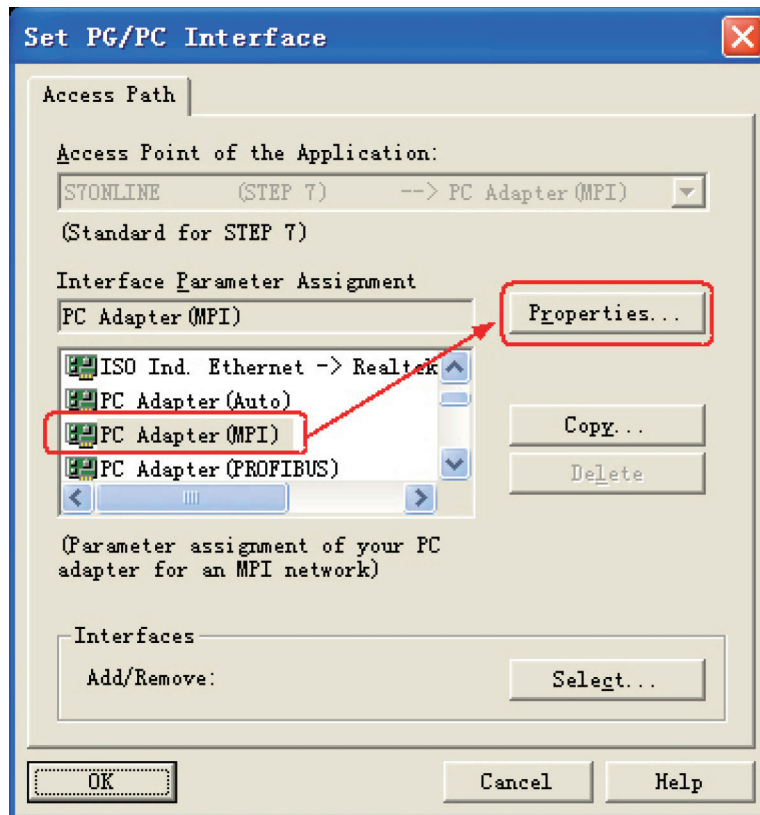

### 2-3-3 SIEMENS S7-200 (SMART) Ethernet (TCP Slave)

#### PT Settings

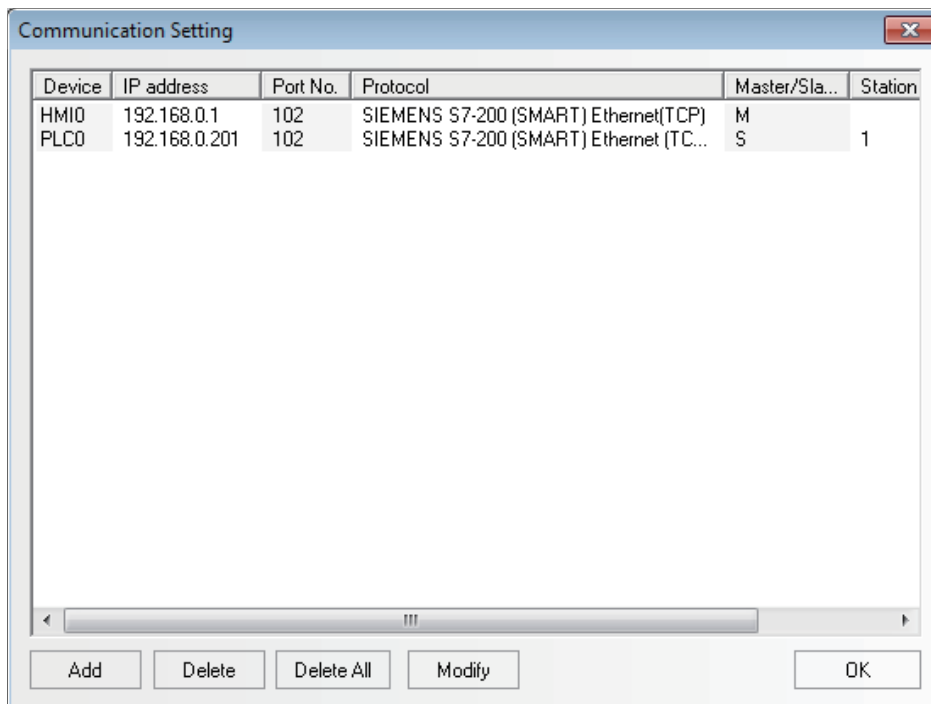
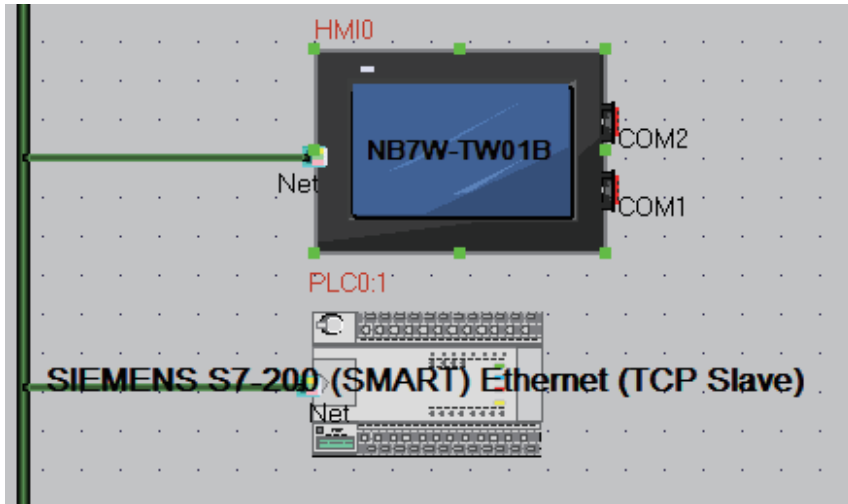

**Note** When you use S7-200 SMART, observe the following setting.  
Set the [PLC property] - [Protocol Time Out 2] to "20".

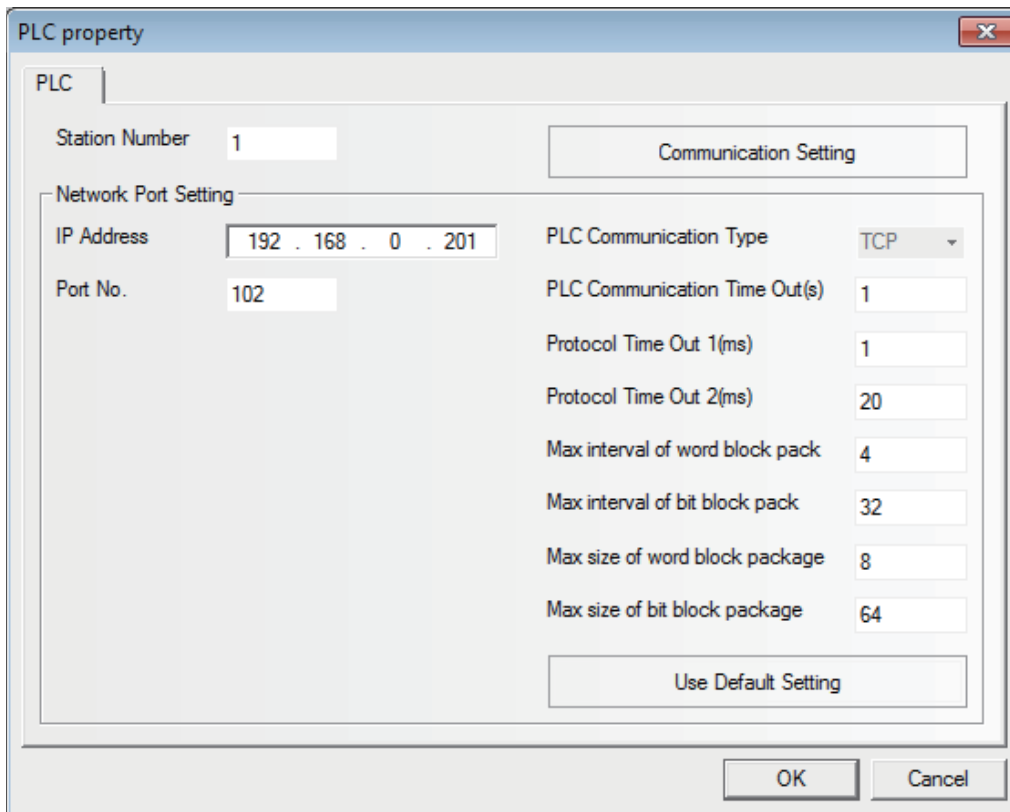

## PLC Settings

### ● Using Ethernet Port of CPU Unit

When you use the Unit that uses built-in Ethernet Port, set the Unit with STEP7-MICRO/WIN Smart.

- 1** Double-click the [Communications].

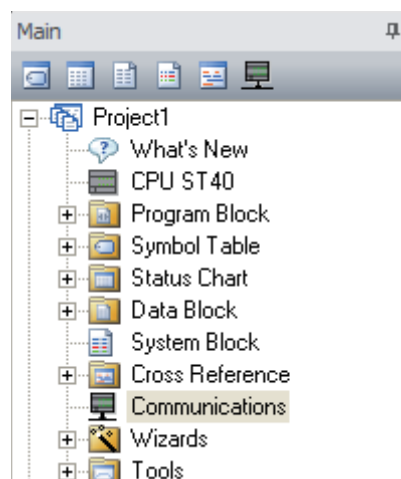

- 2 Connect the PLC to be connected on the Ethernet Network that is connectable with PC and click the [Find CPUs].

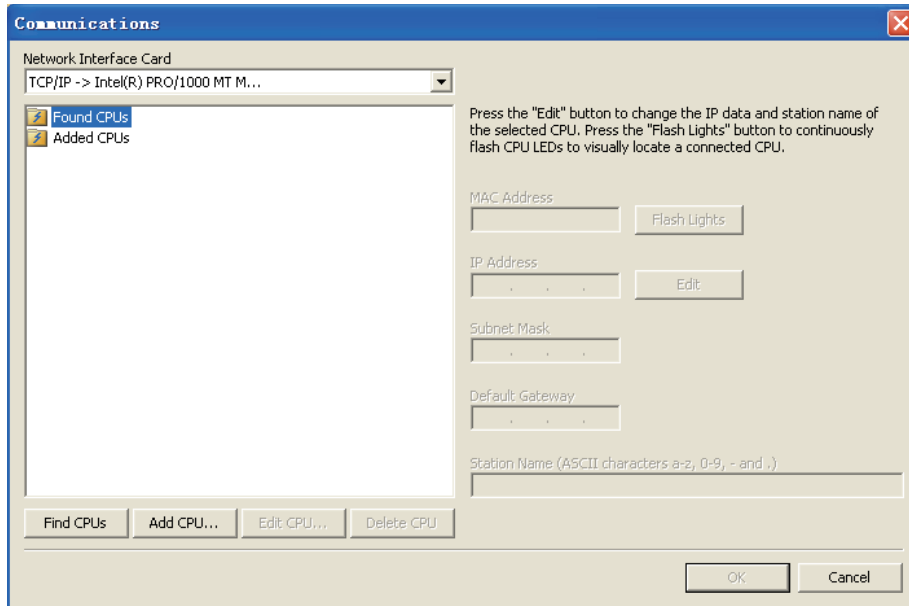

- 3 Select the found CPU and click the [Edit] button.

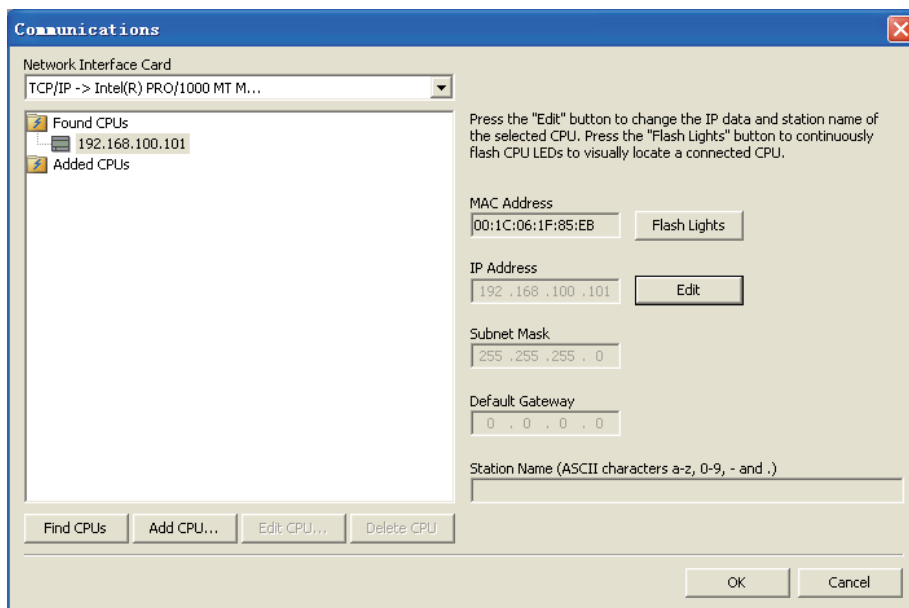



- 4** Set IP address and others and click the [Set] button.

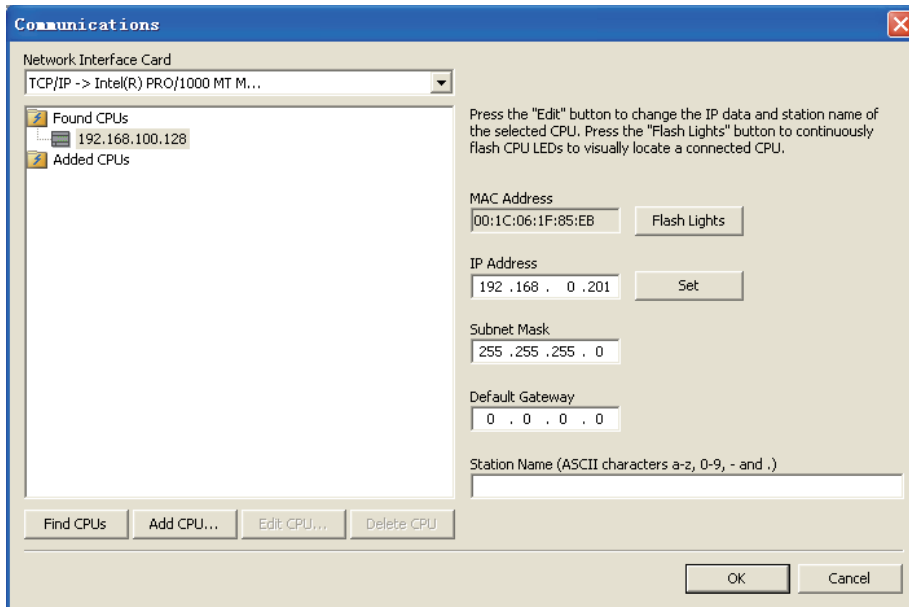

● **Using communication module**

When you use communication module, make settings with STEP7 Micro/Win.

- 1** Select the [Tools] - [Ethernet Wizard...] from Menu.

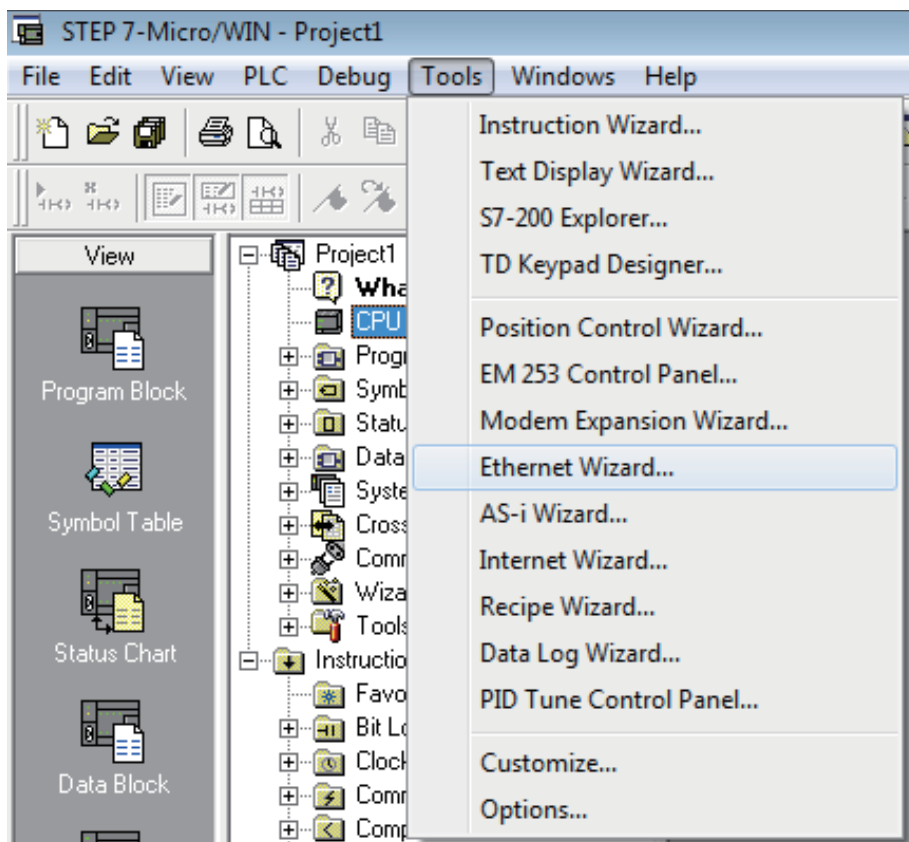

**2** Click the [Next>] button.

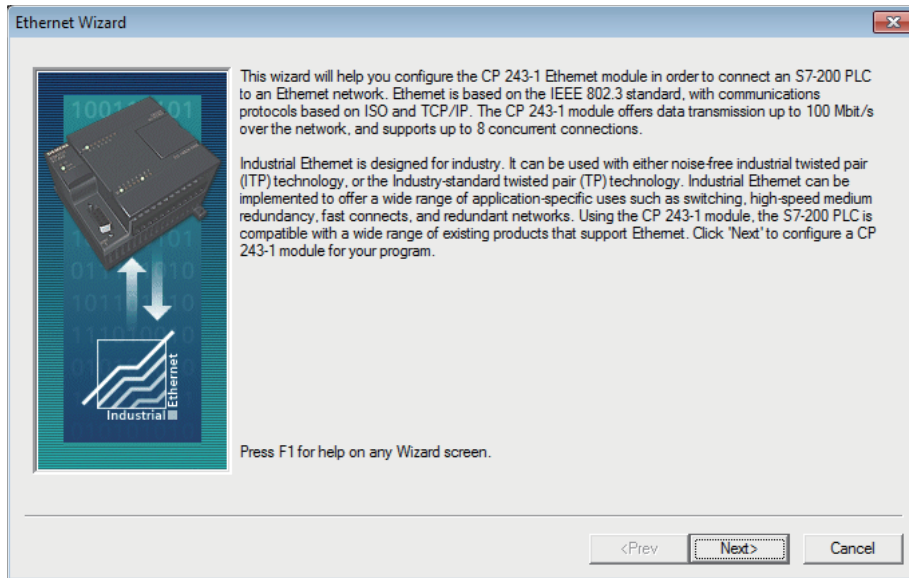

**3** Set the Module Position to "0" and click the [Next>] button.

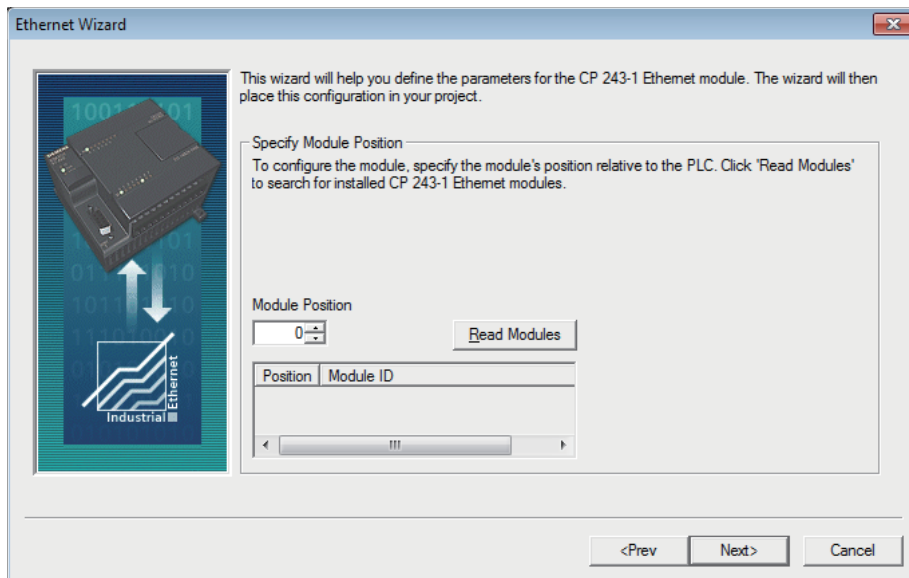

 **Precautions for Correct Use**

In order to communicate with the NB, the Module Position must be "0". If yours not the case, change the CPU configurations and set the Module Position to "0".

- 4** Make settings of IP address and others and select the [Auto Detect Communications] for the [Module Connection Type].  
When completing the settings, click the [Next>] button.

**Ethernet Wizard**

**Module Address**  
If your network provides a BOOTP server (a service that will automatically assign IP addresses at startup), you may choose to have an IP address automatically assigned.

IP Address: 192 . 168 . 0 . 201

Subnet Mask: 255 . 255 . 255 . 0

Gateway Address: . . . .

Allow automatic IP address assignment.

**Module Connection Type**  
Specify the communications connection type for this module.

Auto Detect Communications

<Prev    Next>    Cancel

- 5** Make settings as below and click the [Next>] button.

**Ethernet Wizard**

**Module Command Byte**  
Determine the Q-address by counting the output bytes used by any I/O modules attached to the PLC before the CP 243-1 module.

QB 2

**Peer-to-Peer Connections**  
The CP 243-1 module will support a maximum of 8 asynchronous, concurrent connections. Select how many connections you wish to configure for this module.

Number of connections to configure for this module:  
1 (0-8)

Click 'Next' to edit the connections for this configuration.

<Prev    Next>    Cancel

**6** Make settings as below and click the [OK] button.

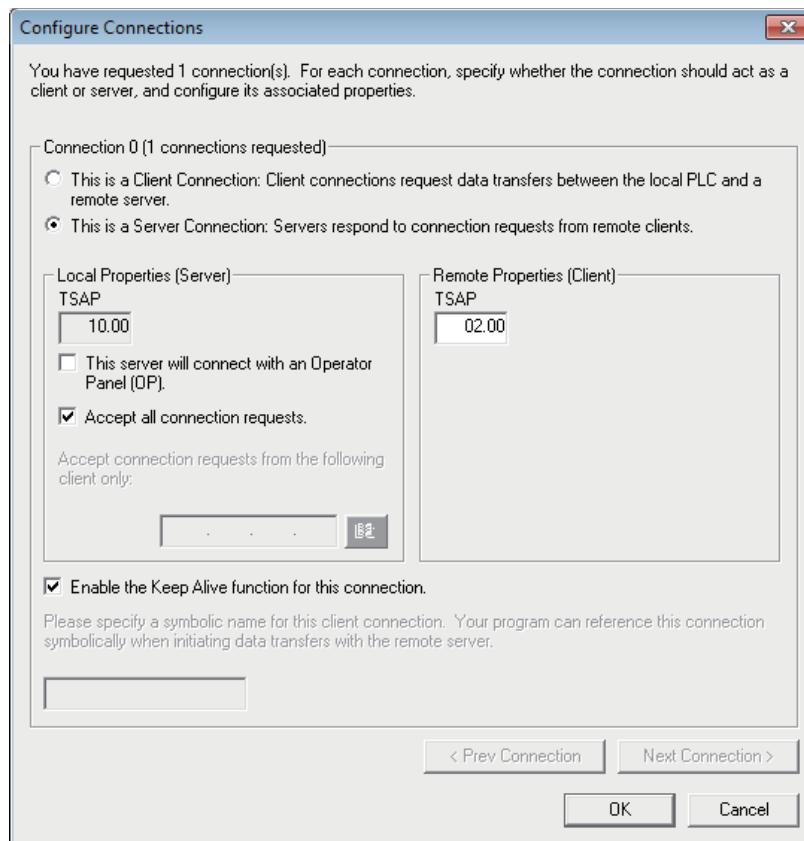

**7** Make settings as below and click the [Next>] button.

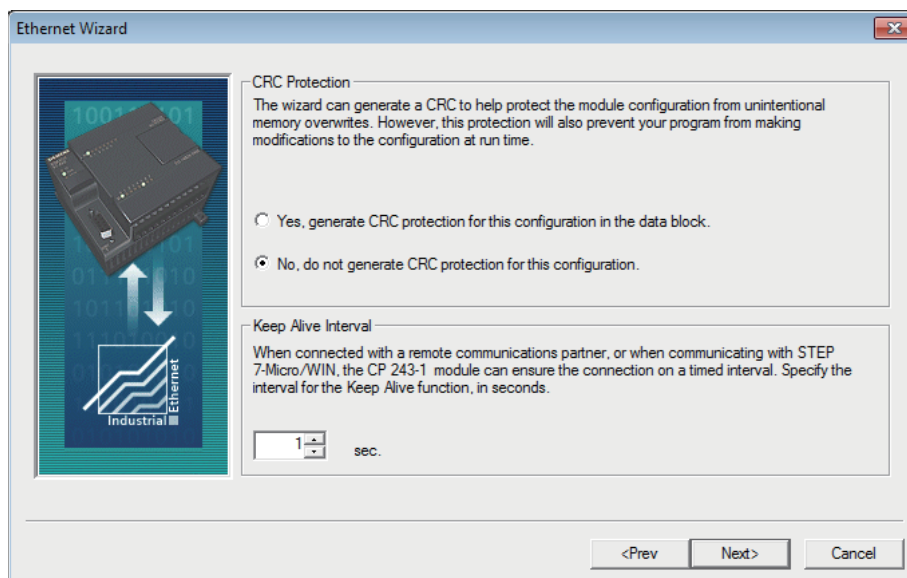

- 8** Click the [Suggest Address] button and then the [Next>] button.

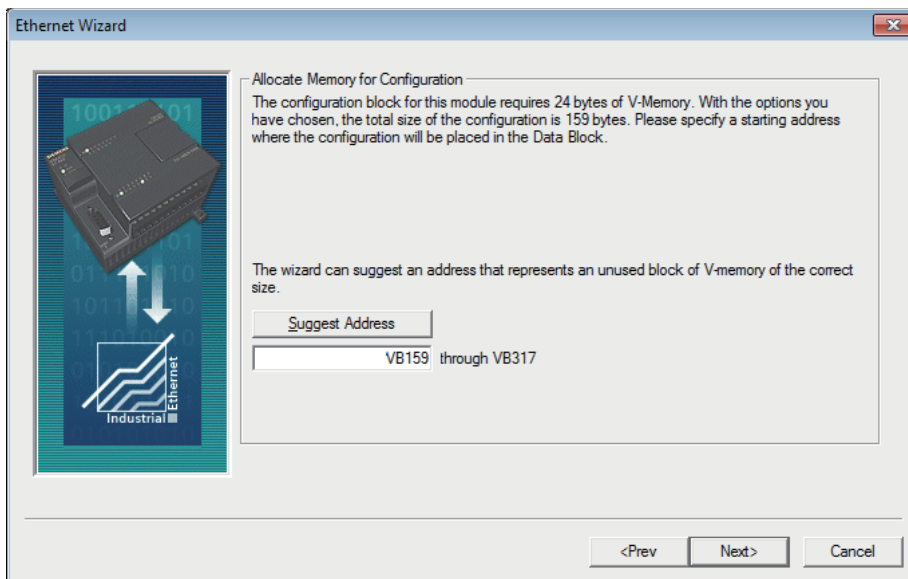

- 9** Click the [Finish] button.

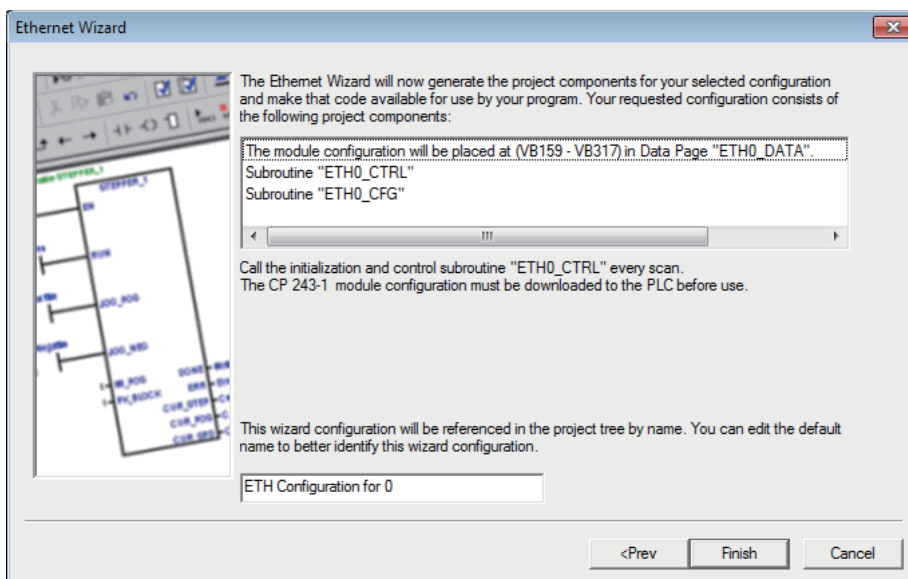

- 10** Click the [Yes] button.

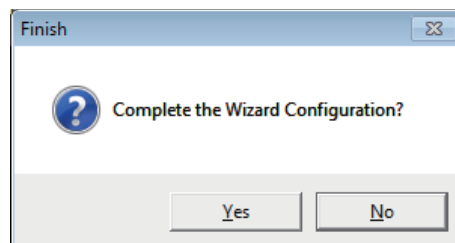

**11** Correct your program to call the subroutine ETH0\_CTRL for each cycle.

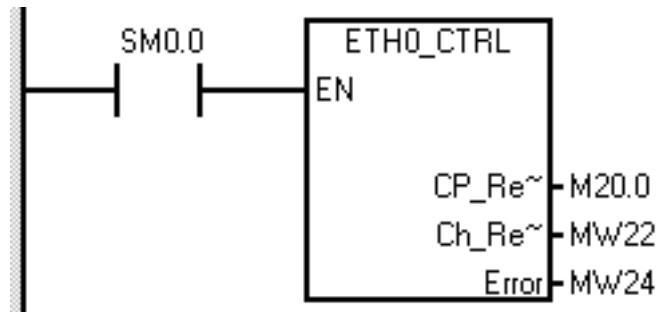

### 2-3-4 SIEMENS S7-300 Ethernet (TCP Slave)

#### PT Settings

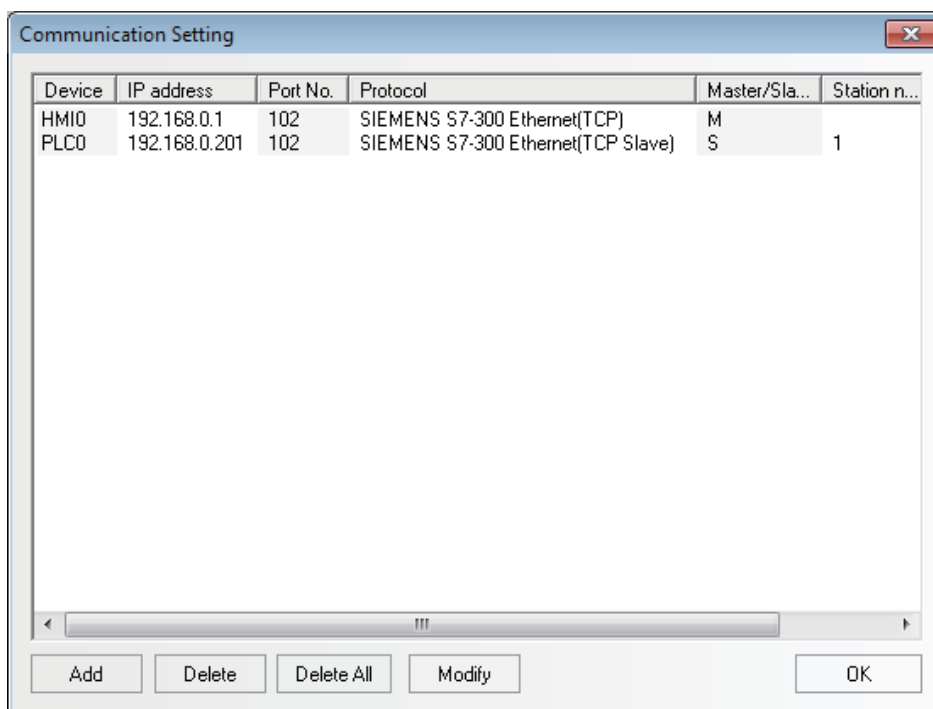
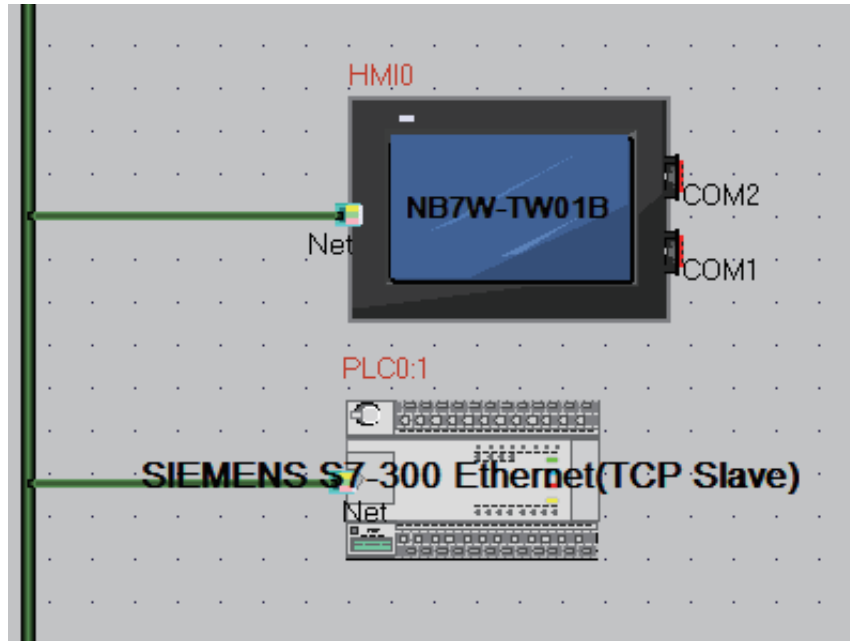

#### PLC Settings

- **Using Ethernet Port of CPU Unit**  
Make settings with SIMATIC STEP 7 (TIA Portal).

- 1 Double-click the [General] tab - [PROFINET interface [X3]] - [Ethernet addresses] and set IP address and others.

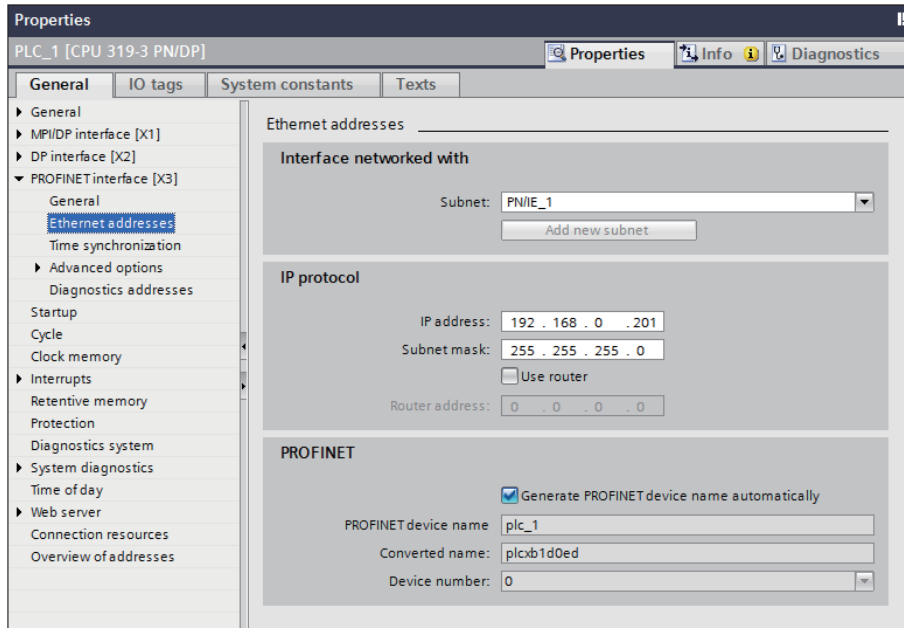

- 2 Transfer the set descriptions to the PLC. If you transfer the descriptions for the first time, select the [Extended download to device] and check the [Show All compatible devices] check box.

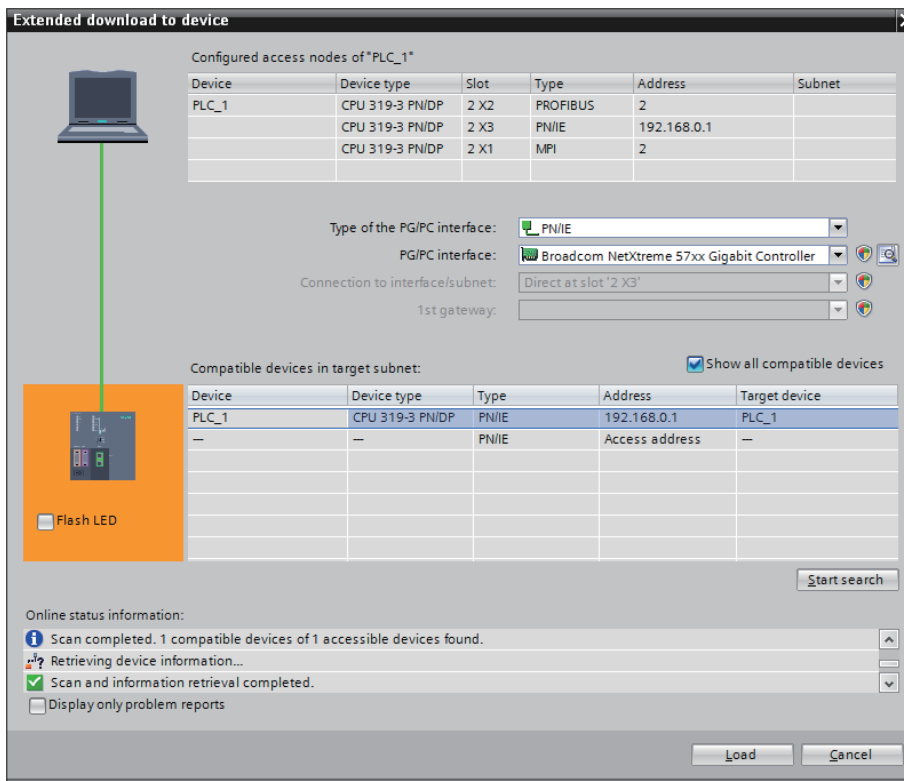



- 3** Create a Data block.  
Double-click the [Project tree] - [Add new block].

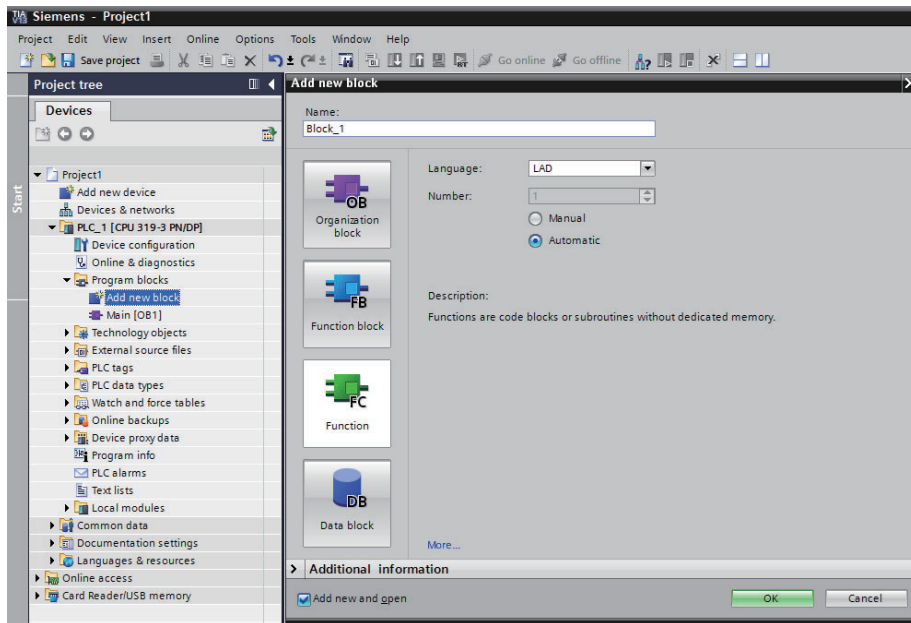

- 4** Click the Data Block.  
Example: If you create a new Data block DB10, make settings as below.

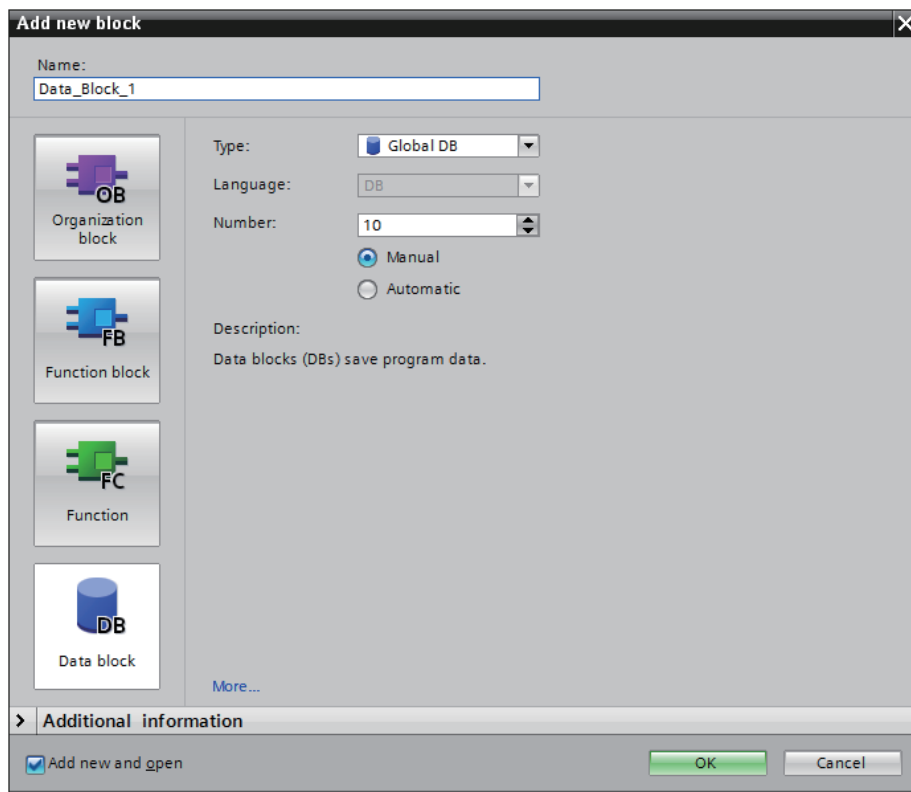



**Additional Information**

- If you use the Data block, the data type of the NB and the PLC should be the same. For instance, if the Data type of the PLC is REAL, the storing data type of the numeric input component should be Float.
- When you define the Data block, secure the larger area than the one used for the NB. For instance, in order to use DB5.DBW32 in the NB, you need to secure DB5.DBW34 or later for the PLC.
- If you use the data block, do not check the check box, [Properties] - [Attributes] - [Only store in load memory].

● **Using communication module**

Make settings with SIMATIC STEP 7 (TIA Portal).

- 1 Open the [Device overview] and click the [PLC].

Module	Rack	Slot	I address	Q address	Type	Order no.
PLC_1	0	1				
CPU 315-2 DP	0	2			CPU 315-2 DP	6ES7 315-2AH14-0AB
MPI interface_1	0	2 X1			MPI interface	
DP interface_1	0	2 X2	2047*		DP interface	
	0	3				
	0	4				
	0	5				
	0	6				
	0	7				
	0	8				
	0	9				
	0	10				
	0	11				

- 2 Click the [General] tab - [MPI address]. Set the [Parameters] - [Address] to "2".

The screenshot shows the 'Properties' window for 'PLC\_1 [CPU 315-2 DP]'. The 'General' tab is selected, and the 'MPI address' sub-tab is active. The 'Interface networked with' section shows 'Subnet: Not networked'. The 'Parameters' section shows 'Address: 2', 'Highest address: 31', and 'Transmission speed: 187.5 kbps'.

**3** Select the Model from [CP 343-1] - [Hardware catalog] and double-click on the Model.

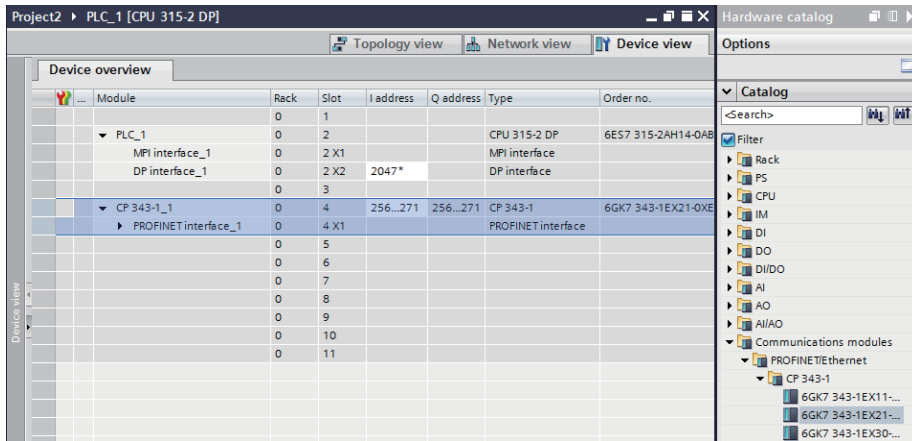

**4** Click the [General] tab - [MPI address]. Set the [Connection to backplane bus] - [Address] to "3".

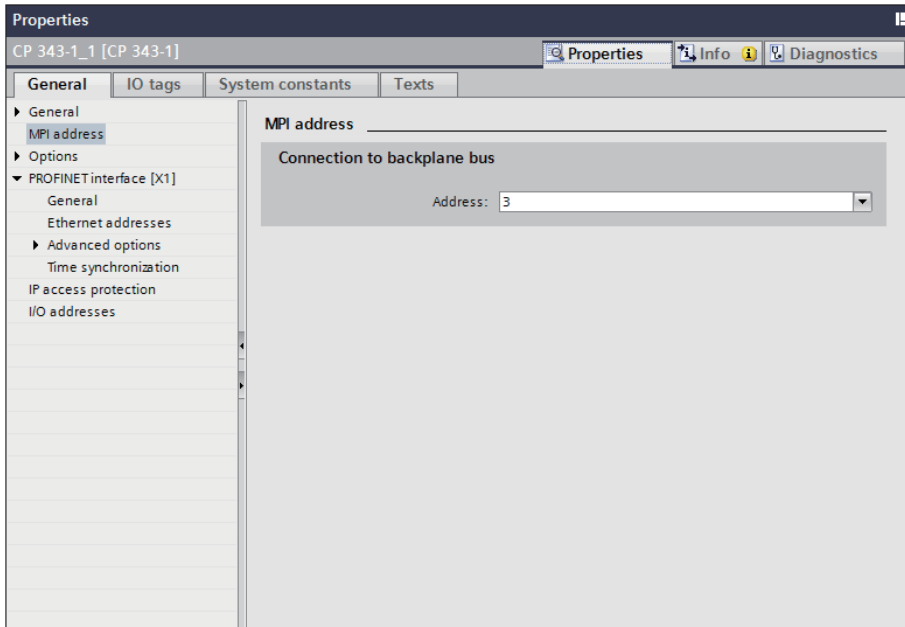

- 5** Click the [General] tab - [Ethernet addresses]. Make settings IP address and others.

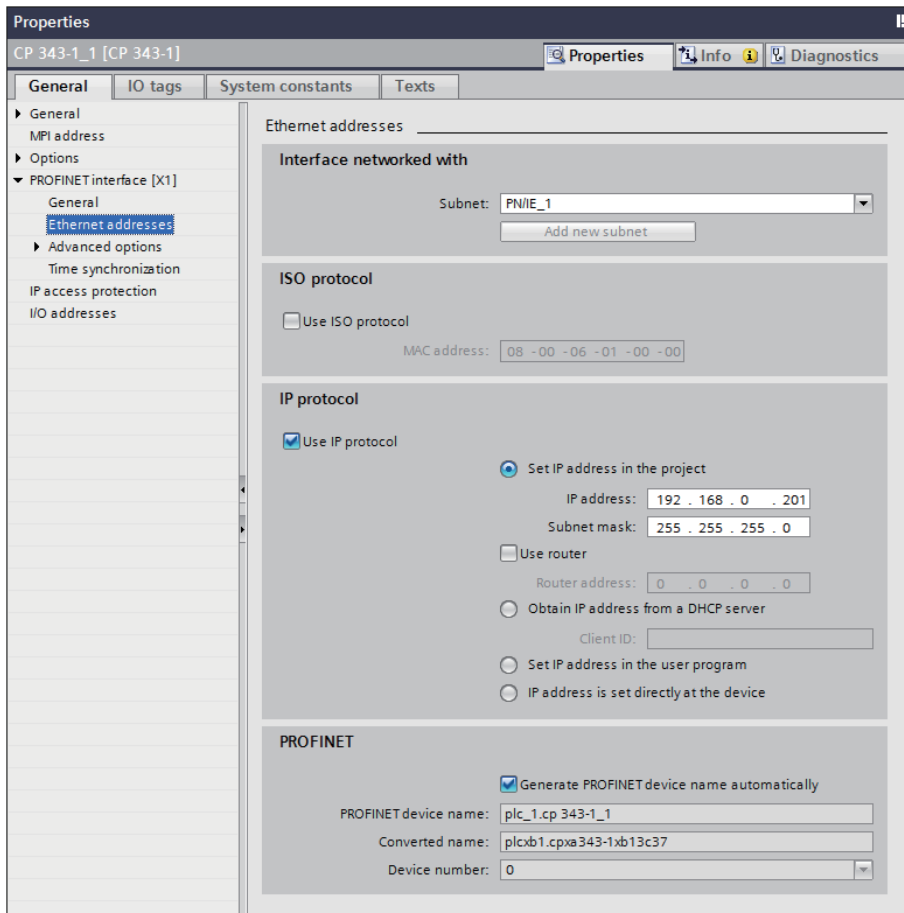

- 6** Download the settings to the PLC.

2-3-5 SIEMENS S7-1200 Ethernet (TCP Slave)

PT Settings

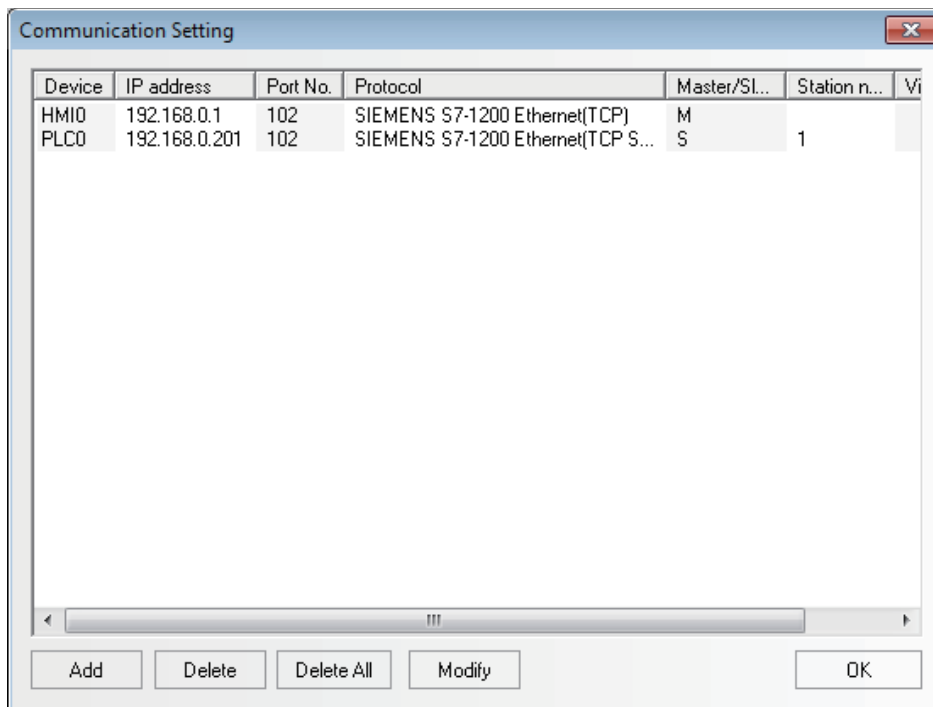
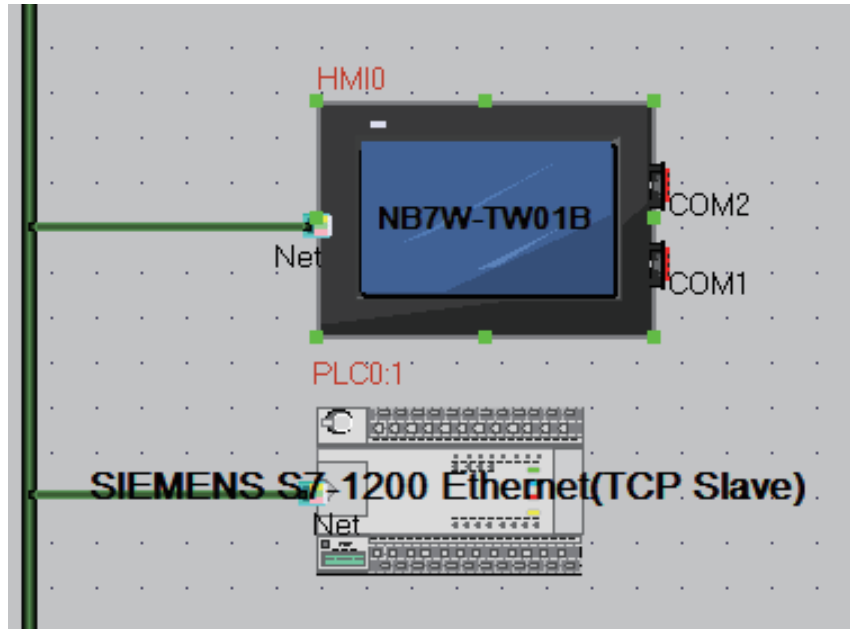

## PLC Settings

Make settings of the PLC using SIMATIC STEP 7 (TIA Portal).

- 1 Double-click the [General] tab - [PROFINET interface] - [Ethernet addresses] and set IP address and others.

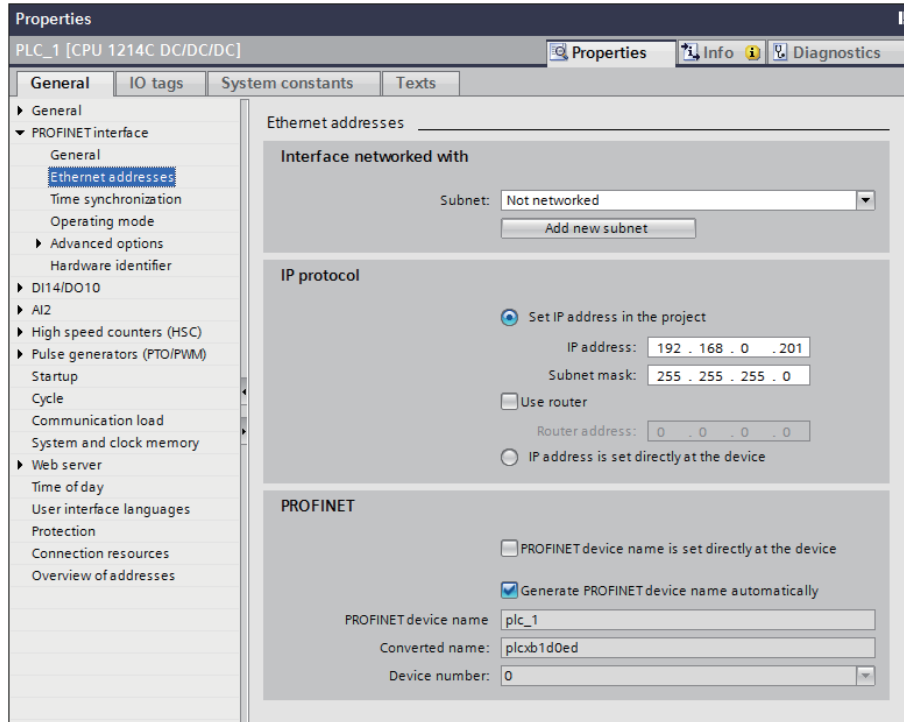

- 2 Transfer the set descriptions to the PLC. If you transfer the descriptions for the first time, select the [Extended download to device] and check the [Show All compatible devices] check box.

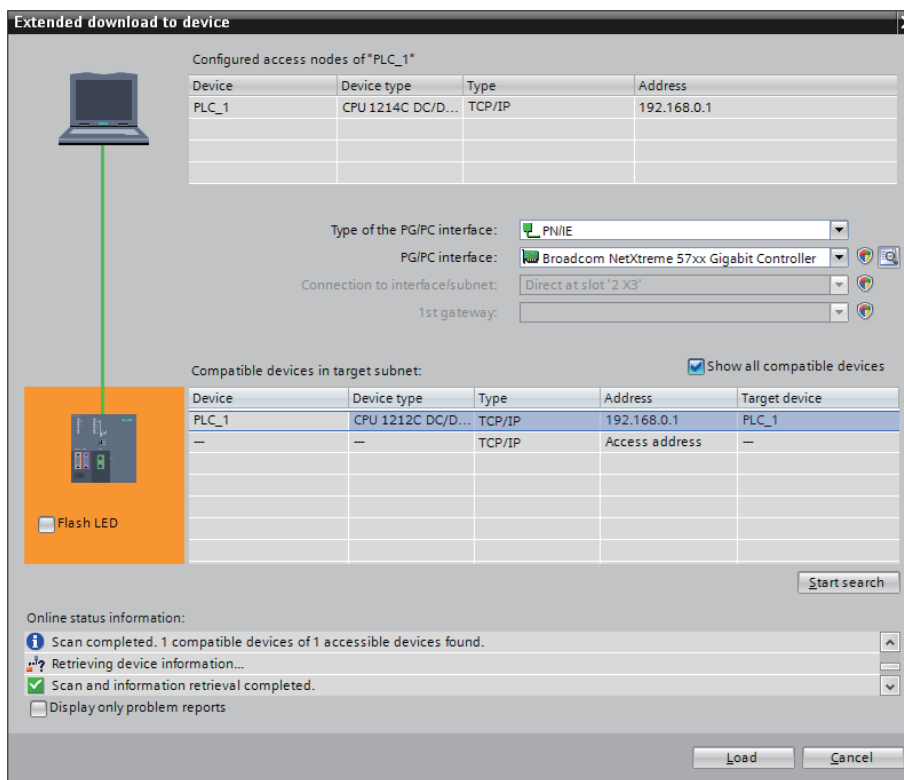

- 3** Create a Data block.  
Double-click the [Project tree] - [Add new block].

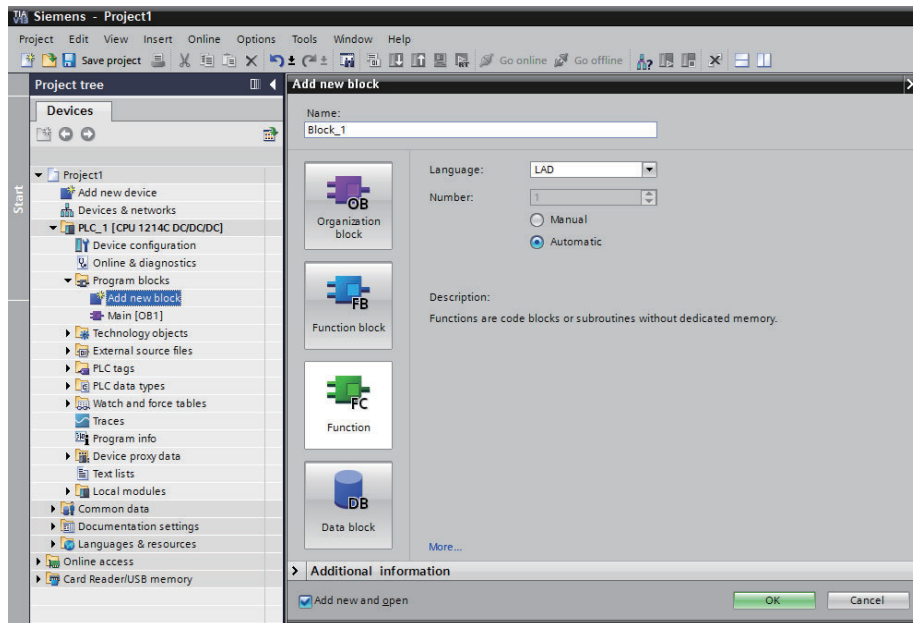

- 4** Click the [Data Block].  
Example: If you should create a new Data block DB10, make settings as below.

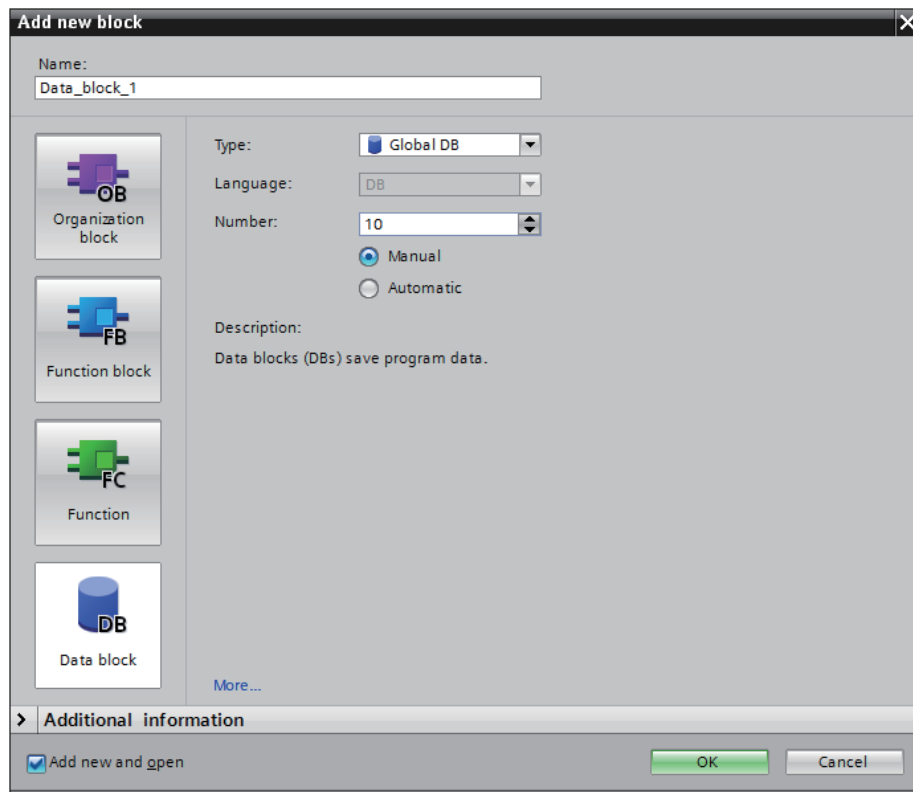



### Precautions for Correct Use

- If you use the Data block, the data type of the NB and the PLC should be the same. For instance, if the Data type of the PLC is REAL, the storing data type of the numeric input component should be Float.
- When you define the Data block, secure the larger area than the one used for the NB. For instance, in order to use DB5.DBW32 in the NB, you need to secure DB5.DBW34 or later for the PLC.
- If you use the data block, do not check the check box, [Properties] - [Attributes] - [Only store in load memory].

## 5 Set options.

Remove check from "Optimized block access" check box.

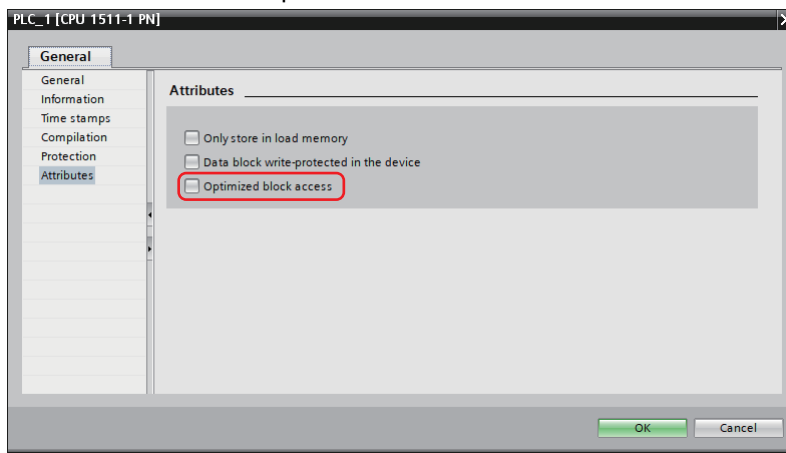

Add check to "Permit access with PUT/GET from remote partner (PLC, HMI, OPC,...)" check box.

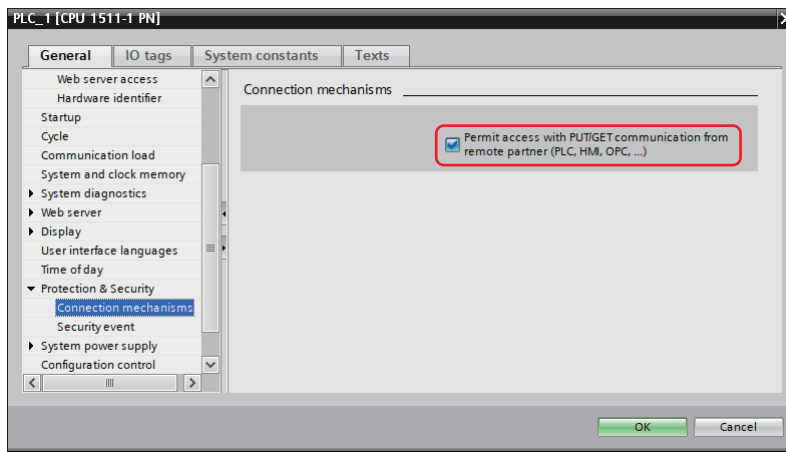



## 2-4 Supported Registers

### 2-4-1 SIEMENS S7-200

Device	Bit Address	Word Address	Format	Notes
SCR Nodes	S.B 0.0~31.7	-----	DD.O	
Special Memory Bit	SM.B 0.0~549.7	-----	DDD.O	
Counter Bit	Cnt 0~255	-----	DDD.O	
Counter Bit	Tim 0~255	-----	DDD.O	
Variable Memory Nodes	V.B 0.0~10238.7	-----	DDDDD.O	
Internal Memory Bit	M.B 0.0~31.7	-----	DD.O	
Discrete Output and Map Register Nodes	Q.B 0.0~15.7	-----	DD.O	
Discrete Input and Map Register Nodes	I.B 0.0~15.7	-----	DD.O	
Analog Output	-----	AQW 0~62	DD	
Analog Input:	-----	AIW 0~62	DD	
SCR (32-bit)	-----	SD 0~28	DD	
SCR	-----	SW 0~30	DD	
Special Memory Registers (32-bit)	-----	SMD 0~546	DDD	
Special Memory Registers	-----	SMW 0~548	DDD	
Internal Memory Bit (32-bit)	-----	MD 0~28	DD	
Internal Memory	-----	MW 0~30	DD	
Discrete Output and Map Registers (32-bit)	-----	QD 0~12	DD	
Discrete Output and Map Registers	-----	QW 0~14	DD	
Discrete Input and Map Registers (32-bit)	-----	ID 0~12	DD	
Discrete Input and Map Registers	-----	IW 0~14	DD	
Counter PV	-----	Cnt 0~255	DDD	
Timer PV	-----	Tim 0~255	DDD	
Variable Memory (32-bit)	-----	VD 0~10236	DDDDD	
Variable Memory	-----	VW 0~10238	DDDDD	

**Note** The initial addresses of VW and VD must be even.  
Address format description: D: decimal, O: octonary, H: hexadecimal.

**2-4-2 SIEMENS S7-300/400 (PC Adapter Direct)**

Device	Bit Address	Word Address	Format	Notes
External Input Nodes	I 0.0~511.7	-----	DDDD.O	
External Output Nodes	Q 0.0~511.7	-----	DDDD.O	
Internal Auxiliary Nodes	M 0.0~4095.7	-----	DDDD.O	
Data Register Nodes	DBm.DBX 0~65535.7	-----	DDDDD.O	m: 10 to 29
Data Registers	-----	DBm.DBW 0~65534	DDDDD	m: 10 to 60
Data Registers (32-bit)	-----	DBm.DBD 0~65532	DDDDD	m: 10 to 60
Internal Registers	-----	MW 0~2046	DDDD	
Internal Registers (32-bit)	-----	MD 0~2044	DDDD	
External Output Registers	-----	QW 0~126	DDD	
External Output Registers (32-bit)	-----	QD 0~124	DDD	
External Input Registers	-----	IW 0~126	DDD	
External Input Registers (32-bit)	-----	ID 0~124	DDD	

**Note** The initial addresses of DBm.DBW and DBm.DBD must be even.  
Address format description: D: decimal, O: octonary, H: hexadecimal.

**2-4-3 SIEMENS S7-200 (Smart) Ethernet (TCP Slave)**

Device	Bit Address	Word Address	Format	Notes
Discrete Input and Map Register Nodes	I.B 0.0~31.7	-----	DD.O	
Internal Memory Bit	M.B 0.0~31.7	-----	DD.O	
Discrete Output and Map Register Nodes	Q.B 0.0~31.7	-----	DD.O	
SCR Nodes	S.B 0.0~31.7	-----	DD.O	
Special Memory Bit	SM.B 0.0~1535.7	-----	DDDD.O	
Variable Memory Nodes	V.B 0.0~8191.7	-----	DDDD.O	
Analog Inputs	-----	AIW 0~110	DDD	
Analog Outputs	-----	AQW 0~110	DDD	
Discrete Input and Map Registers (32-bit)	-----	ID 0~28	DD	
Discrete Input and Map Registers	-----	IW 0~30	DD	
Internal Memory (32-bit)	-----	MD 0~28	DD	
Internal Memory	-----	MW 0~30	DD	
Discrete Output and Map Registers (32-bit)	-----	QD 0~28	DD	
Discrete Output and Map Registers	-----	QW 0~30	DD	
SCR (32-bit)	-----	SD 0~28	DD	
Special Memory Registers (32-bit)	-----	SMD 0~1532	DDDD	
Special Memory Registers	-----	SMW 0~1534	DDDD	
SCR	-----	SW 0~30	DD	
Variable Memory (32-bit)	-----	VD 0~8188	DDDD	
Variable Memory	-----	VW 0~8190	DDDD	

**Note** When you access word access and double word access memories, always specify even address.

### 2-4-4 SIEMENS S7-300 Ethernet (TCP Slave)

Device	Bit Address	Word Address	Format	Note
Data Register Nodes	DBm_DBX 0.0~65535.7	-----	DDDDD.O	m:1 to 10
Data Register Nodes	DBn_DBX 100000.0~25565535.7	-----	DDDDDDDD. O	n:1 to 255
External Input Nodes	I 0.0~2047.7	-----	DDDD.O	
Internal Auxiliary Nodes	M 0.0~8191.7	-----	DDDD.O	
External Output Nodes	Q 0.0~2047.7	-----	DDDD.O	
Data Registers (8-bit)	-----	DBm_DBB 0~65535	DDDDD	m:1 to 10
Data Registers Nodes	-----	DBm_DBB 0~65535	DDDDD	m:1 to 10
Data Registers (32-bit)	-----	DBm_DBD 0~65532	DDDDD	m:1 to 10
Data Registers	-----	DBm_DBW 0~65534	DDDDD	m:1 to 10
Data Registers	-----	DBn_DBB 100000~25565535	DDDDDDDD	n:1 to 255
Data Registers (32-bit)	-----	DBn_DBD 100000~25565532	DDDDDDDD	n:1 to 255
Data Registers	-----	DBn_DBW 100000~25565534	DDDDDDDD	n:1 to 255
External Output Nodes	-----	IB 0~2047	DDDD	
External Input Registers (32-bit)	-----	ID 0~2044	DDDD	
External Input Registers	-----	IW 0~2046	DDDD	
External Input Nodes	-----	MB 0~8191	DDDD	
Internal Registers (32-bit)	-----	MD 0~8188	DDDD	
Internal Registers	-----	MW 0~8190	DDDD	
Internal Assistant Nodes	-----	QB 0~2047	DDDD	
External Output Registers (32-bit)	-----	QD 0~2044	DDDD	
External Output Registers	-----	QW 0~2046	DDDD	

**Note 1** DBn\_DBX, DBn\_DBW, and DBn\_DBD represent custom blocks. The top three digits of the Data block address indicate block number. The other five digits after the block number indicate address. If the address part is less than five digits, fill in '0's. For instance, if you access to DB20.DBX23.4, set DBn\_DBX to 2000023.4.

- 2 When you access word access and double word access memories, always specify even address.
- 3 MB, IB, and QB do not support the signed integer number as data format.
- 4 If you define the Data block, secure the larger area than that used in the NB. For instance, if you use DB5.DBW32 in the NB, you should secure DB5.DBW34 or later in the PLC.
- 5 When you access data block of double word, you cannot access the maximum address.

**2-4-5 SIEMENS S7-1200 Ethernet (TCP Slave)**

Device	Bit Address	Word Address	Format	Note
Data Register Nodes	DBm_DBX 0.0~65535.7	-----	DDDDD.O	m:1 to 10
Data Register Nodes	DBn_DBX 100000.0~25565535.7	-----	DDDDDDDD. O	n:1 to 255
External Input Nodes	I 0.0~1023.7	-----	DDDD.O	
Internal Auxiliary Nodes	M 0.0~8191.7	-----	DDDD.O	
External Output Nodes	Q 0.0~1023.7	-----	DDDD.O	
Data Registers (32-bit)	-----	DBm_DBW 0~65532	DDDDD	m:1 to 10
Data Registers	-----	DBm_DBW 0~65534	DDDDD	m:1 to 10
Data Registers (32-bit)	-----	DBn_DBW 100000~25565532	DDDDDDDD	n:1 to 255
Data Registers	-----	DBn_DBW 100000~25565534	DDDDDDDD	n:1 to 255
External Input Registers (32-bit)	-----	ID 0~1020	DDDD	
External Input Registers	-----	IW 0~1022	DDDD	
Internal Registers (32-bit)	-----	MD 0~8188	DDDD	
Internal Registers	-----	MW 0~8190	DDDD	
External Output Registers (32-bit)	-----	QD 0~1020	DDDD	
External Output Registers	-----	QW 0~1022	DDDD	

**Note 1** The data register of the NB-Designer observes the absolute address of the Data block instead of the S7-1200 global symbol data block.

- 2 DBn\_DBX, DBn\_DBW, and DBn\_DBW represent custom blocks. The top three digits of the Data block address indicate block number. The other five digits after the block number indicate address. If the address part is less than five digits, fill in '0's. For instance, if you access to DB20.DBX23.4, set DBn\_DBX to 2000023.4.
- 3 When you access word access and double word access memories, always specify even address.
- 4 If you define the data block, secure the larger area than that used in the NB. For instance, if you use DB5.DBW32 in the NB, you should secure DB5.DBW34 or later in the PLC.
- 5 When you access data block of double word, you cannot access the maximum address.

## 2-5 Cable Fabrication

### When Using SIEMENS S7-200 Communication Protocol

#### ● RS232 Communication Cable

Use RS-232/PPI multi-host cable and self-made RS232 cable manufactured by SIEMENS to communicate with PT.

- Self-made RS-232 Cable

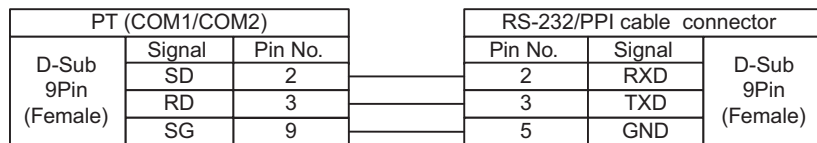

#### ● RS485 Communication Cable

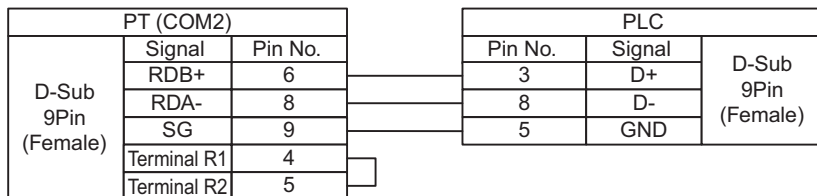

### When Using SIEMENS S7-300/400 (PC Adapter Direct) Communication Protocol

#### ● RS232 Communication Cable

Use MPI-Adapter SSW7, RS232 (Order No.700-751-1VK21) manufactured by Helmholz and RS232 cable to communicate to PT.

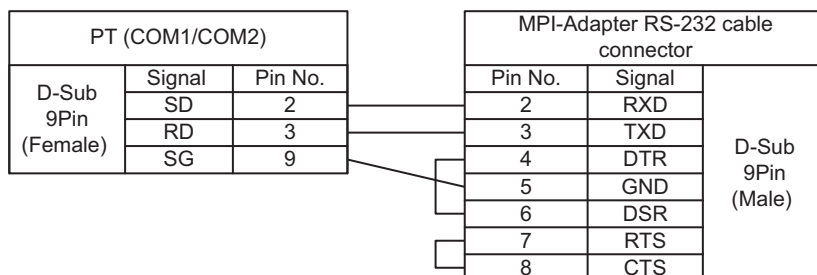



# 3

## Connecting to Mitsubishi PLCs

This section describes the connection to Mitsubishi PLCs.

NB□□-TW□□B and NB□□-TW□□B-V1 support different PLC models, please refer to *Section 1* for details.

---

<b>3-1</b>	<b>Serial Port and Ethernet</b> .....	<b>3-2</b>
3-1-1	Serial Port .....	3-2
3-1-2	Ethernet .....	3-3
<b>3-2</b>	<b>Communication Setting and Cable Connection</b> .....	<b>3-5</b>
3-2-1	Serial Port .....	3-5
3-2-2	Ethernet .....	3-6
<b>3-3</b>	<b>Communication Setting</b> .....	<b>3-7</b>
3-3-1	When Using Mitsubishi FX1S, Mitsubishi FX1N/2N/3G and Mitsubishi FX3U Communication Protocols .....	3-7
3-3-2	When Using Mitsubishi FX-485ADP/485BD/232BD (Multi-station) Communication Protocols .....	3-9
3-3-3	When Using FX2N-10GM/20GM Communication Protocol .....	3-12
3-3-4	When Using Mitsubishi Q00J (CPU Port) Communication Protocol .....	3-13
3-3-5	When Using Mitsubishi Q series (CPU Port) Communication Protocol .....	3-13
3-3-6	When Using Mitsubishi Q06H Communication Protocol .....	3-14
3-3-7	When Using Mitsubishi Q_QnA (Link Port) Communication Protocol .....	3-15
3-3-8	When Using Mitsubishi FX Series Ethernet(TCP Slave) Communication Protocol .....	3-20
3-3-9	When Using Mitsubishi QnA 3EBin Ethernet (TCP Slave) Communication Protocol .....	3-23
3-3-10	When Using Mitsubishi QJ71E71 EtherNet Slave Communication Protocol .....	3-26
<b>3-4</b>	<b>Supported Registers</b> .....	<b>3-29</b>
<b>3-5</b>	<b>Cable Fabrication</b> .....	<b>3-35</b>

## 3-1 Serial Port and Ethernet

### 3-1-1 Serial Port

Series	CPU	Link Module (The products in ( ) are also needed)	Driver
FXCPU	FX1S	RS422 on the CPU unit	Mitsubishi FX1S *2
		FX2NC-485-ADP (FX1N-CNV-BD) FX0N-485-ADP (FX1N-CNV-BD) FX1N-□□□-BD	Mitsubishi FX1S *2 Mitsubishi FX-485ADP/485BD/232BD (Multi-station) *1
		RS422 on the CPU unit	Mitsubishi FX1N/2N/3G *2
	FX1N	FX2NC-485-ADP (FX1N-CNV-BD) FX0N-485-ADP (FX1N-CNV-BD) FX1N-□□□-BD	Mitsubishi FX1N/2N/3G *2 Mitsubishi FX-485ADP/485BD/232BD (Multi-station) *1
		RS422 on the CPU unit	Mitsubishi FX1N/2N/3G *2
		FX2NC-485-ADP (FX1N-CNV-BD) FX0N-485-ADP (FX1N-CNV-BD) FX2N-□□□-BD	Mitsubishi FX1S *2 Mitsubishi FX-485ADP/485BD/232BD (Multi-station) *1
	FX2N	RS422 on the CPU unit	Mitsubishi FX1N/2N/3G *2
		FX2NC-485-ADP (FX1N-CNV-BD) FX0N-485-ADP (FX1N-CNV-BD) FX2N-□□□-BD	Mitsubishi FX1S *2 Mitsubishi FX-485ADP/485BD/232BD (Multi-station) *1
	FX1NC	RS422 on the CPU unit	Mitsubishi FX1N/2N/3G *2
		FX2NC-485-ADP (FX1N-CNV-BD) FX0N-485-ADP (FX1N-CNV-BD)	Mitsubishi FX1N/2N/3G *2 Mitsubishi FX-485ADP/485BD/232BD (Multi-station)
	FX2NC	RS422 on the CPU unit	Mitsubishi FX1N/2N/3G *2
		FX2NC-485-ADP (FX1N-CNV-BD) FX0N-485-ADP (FX1N-CNV-BD)	Mitsubishi FX1N/2N/3G *2 Mitsubishi FX-485ADP/485BD/232BD (Multi-station)
	FX2N-10GM FX2N-20GM	RS422 on the CPU unit	Mitsubishi FX2N_10GM/20GM
	FX3U FX3UC FX3S	RS422 on the CPU unit	Mitsubishi FX3U *2
FX3U-□□□-BD FX3U-485-ADP (FX3U-CNV_BD)		Mitsubishi FX3U *2 Mitsubishi FX-485ADP/485BD/232BD (Multi-station) *1	
FX3G FX3GC	RS422 on the CPU unit	Mitsubishi FX1N/2N/3G *2	
	FX3G-□□□-BD FX3U-485-ADP (FX3G-CNV-ADP)	Mitsubishi FX-485ADP/485BD/232BD (Multi-station) *1	
MELSEC Q	Q00JCPU	RS232 on the CPU unit	Mitsubishi Q00J (CPU Port)
		QJ71C24 QJ71C24-R2 QJ71C24N QJ71C24N-R2 QJ71C24N-R4	Mitsubishi Q_QnA (Link Port)
	Q00CPU Q01CPU	QJ71C24 QJ71C24-R2 QJ71C24N QJ71C24N-R2 QJ71C24N-R4	Mitsubishi Q_QnA (Link Port)
	Q02CPU Q02HCPU Q12HCPU Q25HCPU	RS232 on the CPU unit	Mitsubishi Q Series (CPU Port)
		QJ71C24 QJ71C24-R2 QJ71C24N QJ71C24N-R2 QJ71C24N-R4	Mitsubishi Q_QnA (Link Port)



Series	CPU	Link Module (The products in ( ) are also needed)	Driver
MELSEC Q	Q06HCPU	RS232 on the CPU unit	Mitsubishi Q06H
		QJ71C24 QJ71C24-R2 QJ71C24N QJ71C24N-R2 QJ71C24N-R4	Mitsubishi Q_QnA (Link Port)
	Q00UJCPU	RS232 on the CPU unit	Mitsubishi Q_QnA (Link Port)
	Q06UDHCPU	RS232 on the CPU unit	Mitsubishi Q Series (CPU Port)
MELSEC L	L02CPU L02CPU-P L02SCPU-P L06CPU L06CPU-P L26CPU L26CPU-P L26CPU-BT L26CPU-PBT	LJ71C24 LJ71C24-R2	Mitsubishi Q_QnA (Link Port)
	L02SCPU	RS232C port on CPU Unit LJ71C24 LJ71C24-R2	Mitsubishi Q_QnA (Link Port)

\*1 This protocol supports Multiple Station No..

\*2 This protocol does not support Multiple Station No..

### 3-1-2 Ethernet

Series	CPU	Link Module	Driver
FXCPU	FX3U	FX3U-ENET-L	Mitsubishi FX Series Ethernet (TCP Slave)
MELSEC Q	Q03UDE Q04UDEH Q06UDEH Q10UDEH Q13UDEH Q20UDEH Q26UDEH Q50UDEH Q100UDEH Q03UDV Q04UDV Q06UDV Q13UDV Q26UDV	Ethernet Port on CPU Unit	Mitsubishi QnA 3EBin Ethernet (TCP Slave)
	Q00CPU Q00JCPU Q01CPU Q02CPU Q02HCPU Q06HCPU Q12HCPU Q25HCPU	QJ71E71-100	Mitsubishi QJ71E71 EtherNet Slave

Series	CPU	Link Module	Driver
MELSEC L	L02CPU	Ethernet Port on CPU Unit	Mitsubishi QnA 3EBin Ethernet (TCP Slave)
	L02CPU-P L06CPU L06CPU-P L26CPU L26CPU-P L26CPU-BT L26CPU-PBT	LJ71E71-100	Mitsubishi QJ71E71 EtherNet Slave
	L02SCPU L02SCPU-P	LJ71E71-100	Mitsubishi QJ71E71 EtherNet Slave

## 3-2 Communication Setting and Cable Connection

### 3-2-1 Serial Port

Series	CPU	Link Module	COMM Type	Parameter	Cable
FXCPU	FX1S FX1N FX2N	RS422 on the CPU unit	RS422	Refer to Section 3-3	Self-made cable required
		RS232 Module	RS232		
		RS485 Module	RS422		
	FX1NC FX2NC	RS422 on the CPU unit	RS422		
		RS485 Module	RS422		
	FX2N-10GM FX2N-20GM	RS422 on the CPU unit	RS422		
	FX3G FX3GC	RS422 on the CPU unit	RS422		
		RS232 Module	RS232		
		RS485 Module	RS422		
	FX3UC FX3U FX3S	RS422 on the CPU unit	RS422		
		RS232 Module	RS422		
		RS485 Module	RS422		
MELSEC Q	Q00JCPU Q02CPU Q02HCPU Q12HCPU Q25HCPU Q06HCPU Q00UJ CPU Q06UDHCPU	RS232 on the CPU unit	RS232		
	Q00JCPU Q00CPU Q01CPU Q02CPU Q02HCPU Q12HCPU Q25HCPU Q06HCPU	QJ71C24 QJ71C24-R2	RS232		
		QJ71C24N QJ71C24N-R2			
		QJ71C24 QJ71C24N	RS422		
		QJ71C24N-R4			
MELSEC L	L02SCPU	RS232 on the CPU unit	RS232		
	L02CPU L02CPU-P L02SCPU L02SCPU-P L06CPU L06CPU-P L26CPU L26CPU-P L26CPU-BT L26CPU-PBT	LJ71C24 LJ71C24-R2	RS232		
		LJ71C24	RS422		

### 3-2-2 Ethernet

Series	CPU	Link Module	COMM Type	Parameter	Cable
FXCPU	FX3U	FX3U-ENET-L	-	Refer to Section 3-3	Network Cable
MELSEC Q	Q00JCPU Q00CPU Q01CPU Q02CPU Q02HCPU Q06HCPU Q12HCPU Q25HCPU	QJ71E71-100	-		
	Q03UDECPU Q04UDEHCPU Q06UDEHCPU Q10UDEHCPU Q13UDEHCPU Q20UDEHCPU Q26UDEHCPU Q50UDEHCPU Q100UDEHCPU Q03UDVCPU Q04UDVCPU Q06UDVCPU Q13UDVCPU Q26UDVCPU	Ethernet Port on CPU Unit	-		
MELSEC L	L02SCPU L02SCPU-P	LJ71E71-100	-		
	L02CPU L02CPU-P L06CPU L06CPU-P L26CPU L26CPU-P L26CPU-BT L26CPU-PBT	Ethernet Port on CPU Unit LJ71E71-100	-		

## 3-3 Communication Setting

### 3-3-1 When Using Mitsubishi FX1S, Mitsubishi FX1N/2N/3G and Mitsubishi FX3U Communication Protocols

#### PT Settings

PT default communication parameters: 9600bps (Baud Rate), 7 (Data Bit), even (Parity Check), 1 (Stop Bit) and 0 (PLC Station No.)

The PLC Communication Time Out, Max interval of word (bit) block pack, Max size of word(bit) block package on the right of the dialog box vary with PLC protocols. Generally the defaults are selected.

**Note** This protocol can be used when communicating with the PLC through the programming port of the CPU and the Functions Extension board. This Protocol does not support Multiple Station No. of the Function Extension board. The supporting Baud Rates are as follows. If other Baud Rates than these are selected, the communication is unavailable.

9600bps, 115200bps: FX3G, FX3GC, FX3S, FX3U, FX3UC

9600bps fixed: other CPUs than above

RS422 Communication

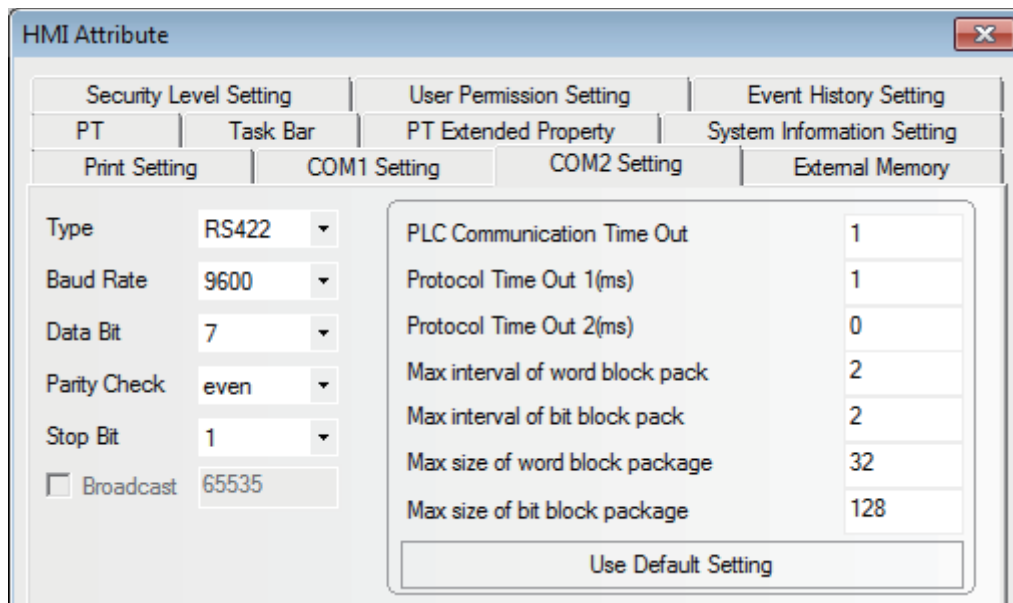

## RS232 Communication

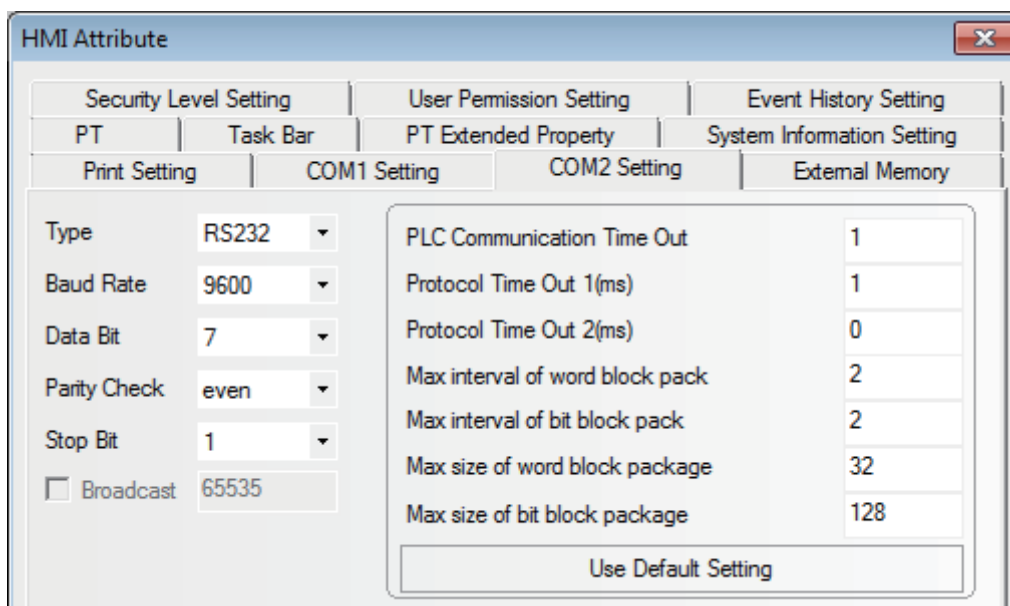

## PLC Settings

The PLC setting is as shown below when **Mitsubishi FX1S**, **Mitsubishi FX1N/2N/3G** and **Mitsubishi FX3U** communication protocols are used:

Click the [Default] button to make settings without checking the [Communication Setting]:

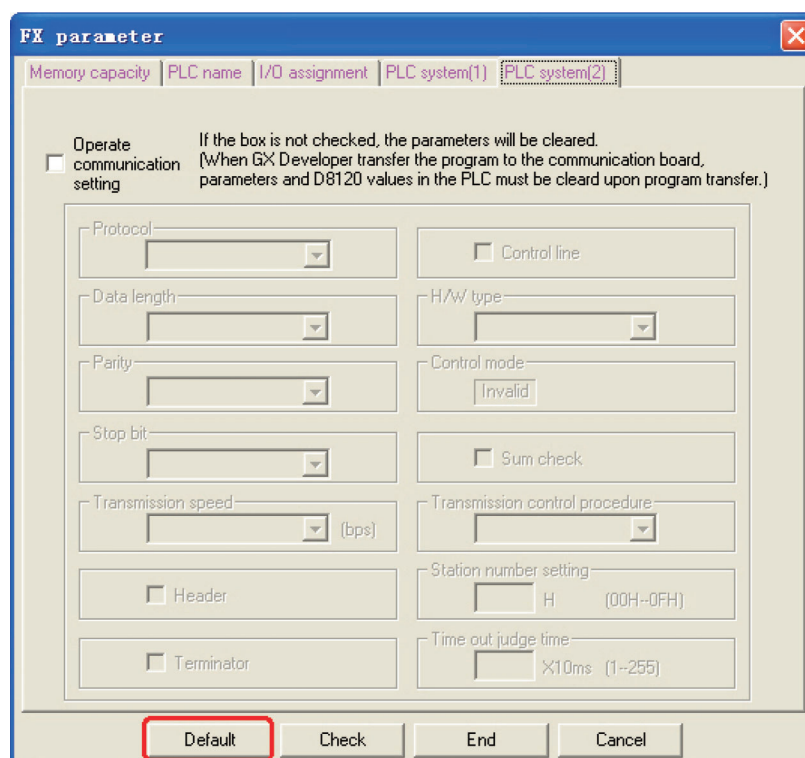

**Note 1** The communication protocols such as Mitsubishi FX1S, Mitsubishi FX1N/2N/3G and Mitsubishi FX3U etc. can be selected according to PLC model if the Station No. is not used when the communication is realized through the communication function expansion board.

**2** Make sure the value of communication format D8120 is 0 when the communication is realized through the communication function expansion board.

### 3-3-2 When Using Mitsubishi FX-485ADP/485BD/232BD (Multi-station) Communication Protocols

#### PT Settings

PT default communication parameters: 19200bps (Baud Rate), 7(Data Bit), even (Parity Check), 2 (Stop Bit) and 0 (PLC Station No.)

Note: The protocols are only applicable to PLCs communicating through communication function expansion board and support Multiple Station No. and Baud Rate settings.

RS422 Communication

The screenshot shows the 'HMI Attribute' dialog box with the 'COM2 Setting' tab selected. The 'Type' is set to 'RS422'. The communication parameters are: Baud Rate: 19200, Data Bit: 7, Parity Check: even, Stop Bit: 2, and Broadcast: 65535 (unchecked). The PLC communication parameters are: PLC Communication Time Out: 1, Protocol Time Out 1(ms): 1, Protocol Time Out 2(ms): 0, Max interval of word block pack: 4, Max interval of bit block pack: 4, Max size of word block package: 10, and Max size of bit block package: 8. A 'Use Default Setting' button is at the bottom.

Parameter	Value
Type	RS422
Baud Rate	19200
Data Bit	7
Parity Check	even
Stop Bit	2
Broadcast	<input type="checkbox"/> 65535
PLC Communication Time Out	1
Protocol Time Out 1(ms)	1
Protocol Time Out 2(ms)	0
Max interval of word block pack	4
Max interval of bit block pack	4
Max size of word block package	10
Max size of bit block package	8

RS232 Communication

The screenshot shows the 'HMI Attribute' dialog box with the 'COM1 Setting' tab selected. The 'Type' is set to 'RS232'. The communication parameters are: Baud Rate: 19200, Data Bit: 7, Parity Check: even, Stop Bit: 2, and Broadcast: 65535 (unchecked). The PLC communication parameters are: PLC Communication Time Out: 1, Protocol Time Out 1(ms): 1, Protocol Time Out 2(ms): 0, Max interval of word block pack: 4, Max interval of bit block pack: 4, Max size of word block package: 10, and Max size of bit block package: 8. A 'Use Default Setting' button is at the bottom.

Parameter	Value
Type	RS232
Baud Rate	19200
Data Bit	7
Parity Check	even
Stop Bit	2
Broadcast	<input type="checkbox"/> 65535
PLC Communication Time Out	1
Protocol Time Out 1(ms)	1
Protocol Time Out 2(ms)	0
Max interval of word block pack	4
Max interval of bit block pack	4
Max size of word block package	10
Max size of bit block package	8

## PLC Settings

The PLC setting is as shown below when **FX-485ADP/485BD/232BD (Multi-station)** communication protocols are used:

- 1 Double-click the [PLC Parameter] under [Project Data List] in GX Developer software.



- 2 Open the [FX Parameter] dialog box.

(1) FX1S/FX1N/FX2N/3G Series PLC

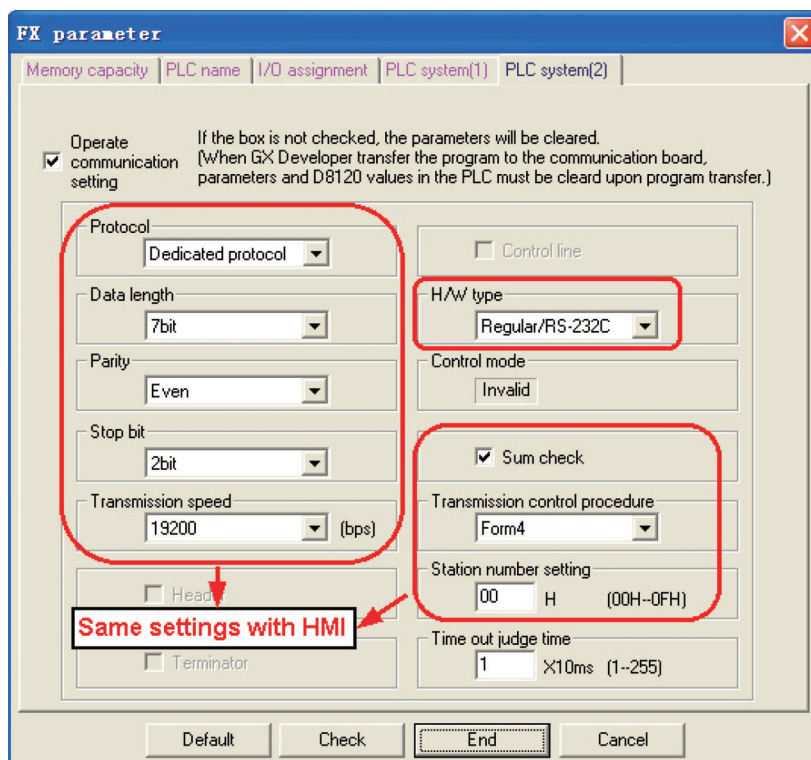

Check the [Operate communication setting] option.

**Note 1** Set the parameters as follows.

The [Dedicated Protocol] is selected for Protocol, the [Sum Check] is checked, and [Form4] is selected for the Transmission Control Sequence.

**2** Set the [H/W Type] as follows.

“Regular/RS-232C” is selected when FX□□-232-BD communications is used or “RS-485” is selected when FX-232-BD or FX□□-485-BD/FX□□-485-ADP communications is used.



## (2) FX3U/3UC Series PLC

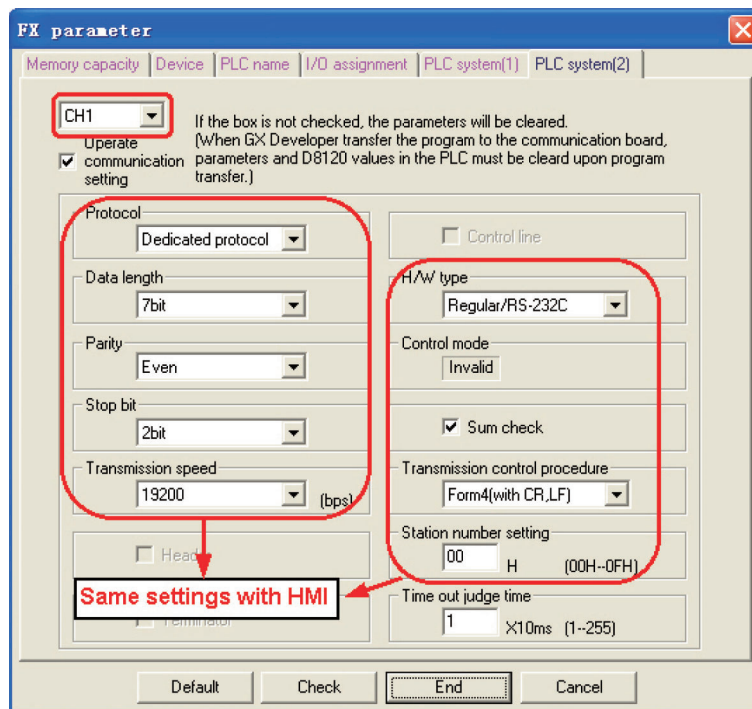

Check the [Operate communication setting] option.

**Note 1** The [CH1] should be selected for FX3U/3UC Series PLC.

2 Set the parameters as follows.

[Dedicated Protocol] is selected for Protocol, [Sum Check] is checked, and [Form4] is selected for the Transmission Control Sequence.

3 Set the [H/W Type] as follows.

“Regular/RS-232C” is selected when FX□□-232-BD communications is used or “RS-485” is selected when FX□□-485-BD/FX□□-485-ADP communications is used.

Aside from using [FX Parameter], the user can use the special data register D8120 in PLC to set the communication parameters for PLC.

Special Data Registers	Descriptions
D8120	Communication format
D8121	Station No. setting
D8129	Data network out-time counting

Applicable to FX3U/3UC and other FX Series PLCs using CH1

- For example:

If the PLC communication parameters are: 9600bps (Baud Rate), 7 (Data Bit), even (Parity Check), 2 (Stop Bit), 1(PLC Station No.), RS485 (Communication Method) and 1 (PLC Communication Time Out), then D8120=0xE08E,

D8121=1,

and D8129=1.

**Note** The settings will be valid when the PLC is restarted after the D8120 setting is modified.

### 3-3-3 When Using FX2N-10GM/20GM Communication Protocol

#### PT Settings

PT default communication parameters: 9600bps (Baud Rate), 8 (Data Bit), even (Parity Check), 1 (Stop Bit) and 0 (PLC Station No.)

**Note** This protocol can be used when communicating with the PLC through the programming port of the CPU and the Functions Extension board. The baud rate is fixed to 9600 bps. If the baud rate is set to the other speed, the communications cannot be available. The protocol does not support the multiple station No. of the Functions Extension board.

#### RS232 Communication

The screenshot shows the 'HMI Attribute' dialog box with the 'COM1 Setting' tab selected. The 'Type' is set to 'RS232'. The communication parameters are: Baud Rate: 9600, Data Bit: 8, Parity Check: even, Stop Bit: 1, and Broadcast: 65535 (unchecked). The 'PLC Communication Time Out' is 1. The 'Protocol Time Out 1(ms)' is 30, and 'Protocol Time Out 2(ms)' is 0. The 'Max interval of word block pack' is 16, 'Max interval of bit block pack' is 1, 'Max size of word block package' is 32, and 'Max size of bit block package' is 1. A 'Use Default Setting' button is at the bottom.

Parameter	Value
Type	RS232
Baud Rate	9600
Data Bit	8
Parity Check	even
Stop Bit	1
Broadcast	65535
PLC Communication Time Out	1
Protocol Time Out 1(ms)	30
Protocol Time Out 2(ms)	0
Max interval of word block pack	16
Max interval of bit block pack	1
Max size of word block package	32
Max size of bit block package	1

#### RS422 Communication

The screenshot shows the 'HMI Attribute' dialog box with the 'COM1 Setting' tab selected. The 'Type' is set to 'RS422'. The communication parameters are: Baud Rate: 9600, Data Bit: 8, Parity Check: even, Stop Bit: 1, and Broadcast: 65535 (unchecked). The 'PLC Communication Time Out' is 1. The 'Protocol Time Out 1(ms)' is 30, and 'Protocol Time Out 2(ms)' is 0. The 'Max interval of word block pack' is 16, 'Max interval of bit block pack' is 1, 'Max size of word block package' is 32, and 'Max size of bit block package' is 1. A 'Use Default Setting' button is at the bottom.

Parameter	Value
Type	RS422
Baud Rate	9600
Data Bit	8
Parity Check	even
Stop Bit	1
Broadcast	65535
PLC Communication Time Out	1
Protocol Time Out 1(ms)	30
Protocol Time Out 2(ms)	0
Max interval of word block pack	16
Max interval of bit block pack	1
Max size of word block package	32
Max size of bit block package	1

### 3-3-4 When Using Mitsubishi Q00J (CPU Port) Communication Protocol

#### PT Settings

PT default communication parameters: 19200bps (Baud Rate), 8 (Data Bit), odd (Parity Check), 1 (Stop Bit) and 0 (PLC Station No.) (Multiple Station No. is not supported.)

RS232 Communication

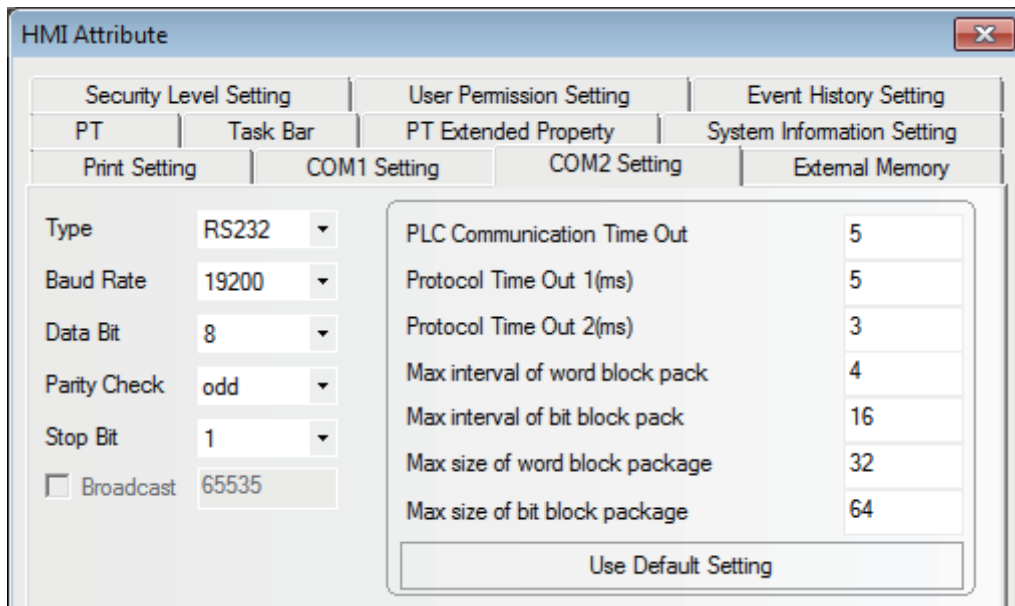

**Note** There is no need to set PLC baud rate that will automatically vary with the baud rate set by PT.

### 3-3-5 When Using Mitsubishi Q series (CPU Port) Communication Protocol

#### PT Settings

PT default communication parameters: 115200bps (Baud Rate), 8 (Data Bit), odd (Parity Check), 1 (Stop Bit) and 0 (PLC Station No.) (Multiple Station No. is not supported.)

#### RS232 Communication

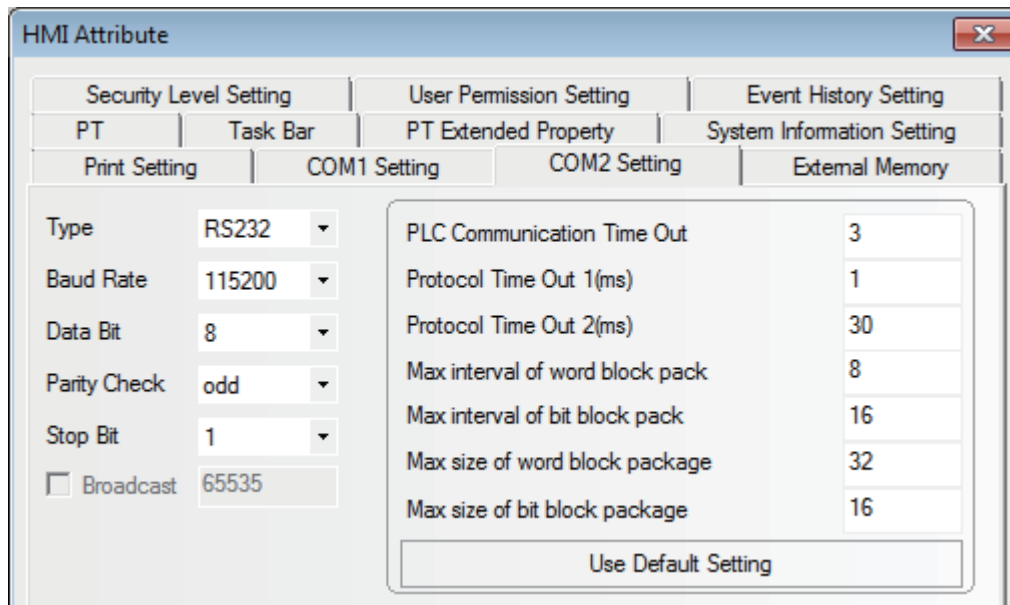

**Note** There is no need to set PLC baud rate that will automatically vary with the baud rate set by PT.

### 3-3-6 When Using Mitsubishi Q06H Communication Protocol

#### PT Settings

PT default communication parameters: 115200bps (Baud Rate), 8 (Data Bit), odd (Parity Check), 1 (Stop Bit) and 0 (PLC Station No.) (Multiple Station No. is not supported.)

#### RS232 Communication

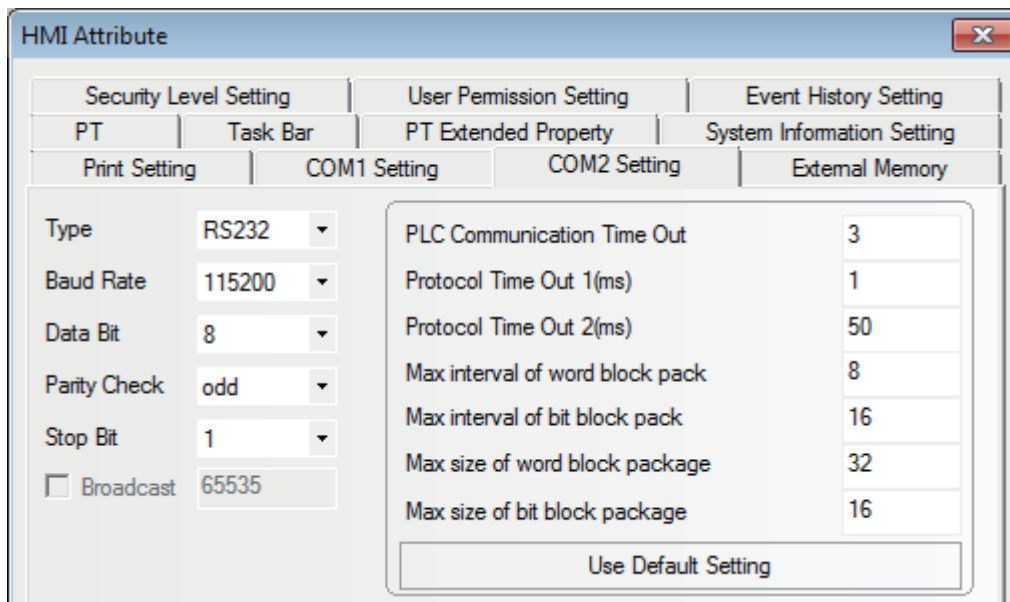

**Note** There is no need to set PLC baud rate that will automatically vary with the baud rate set by PT.

### 3-3-7 When Using Mitsubishi Q\_QnA (Link Port) Communication Protocol

#### PT Settings

PT default communication parameters: 9600bps (Baud Rate), 8 (Data Bit), odd (Parity Check), 1 (Stop Bit) and 0 (PLC Station No.)

RS232 Communication

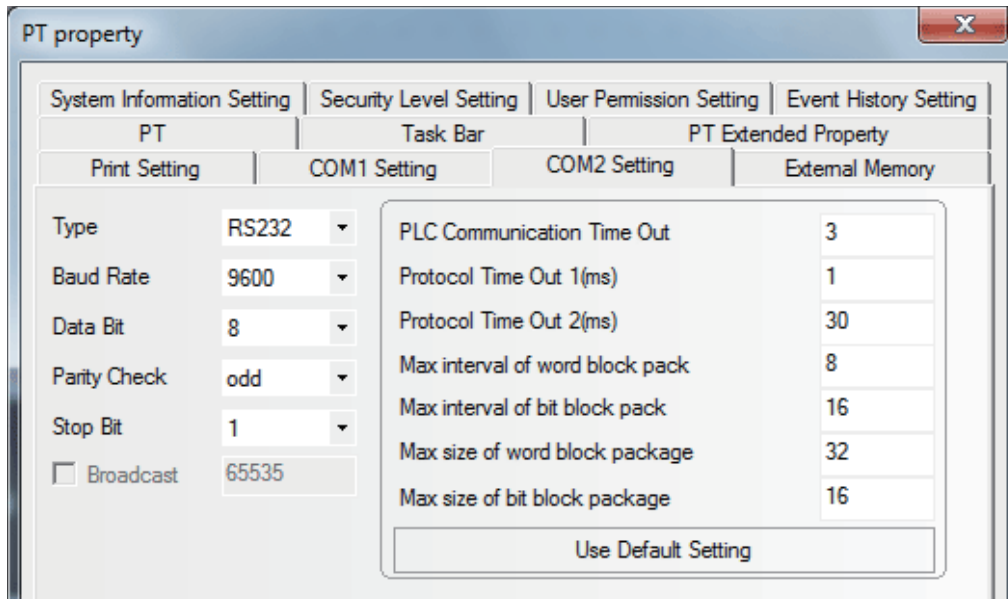

RS422 Communication

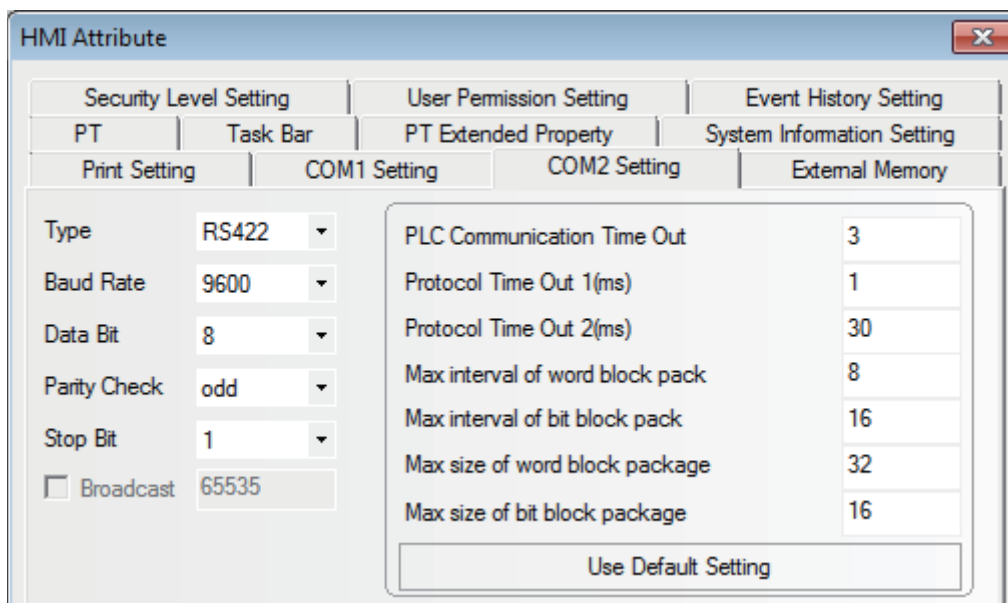

## PLC Settings

The PLC settings is as shown below when **Mitsubishi Q\_QnA (Link Port)** or **Mitsubishi Melsec Q** communication protocols are used:

### ● Communication through CPU Port

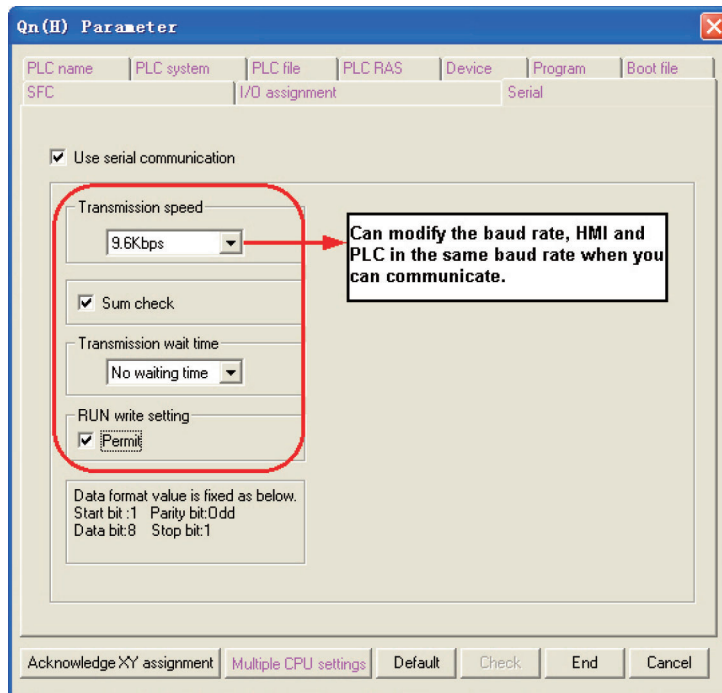

### ● Communication through C24 Serial Port Communication Module

- 1 Open [Parameter] on Project Data List and double-click [PLC parameter], and select [I/O assignment] after the [Qn (H) Parameter] dialog box is opened.

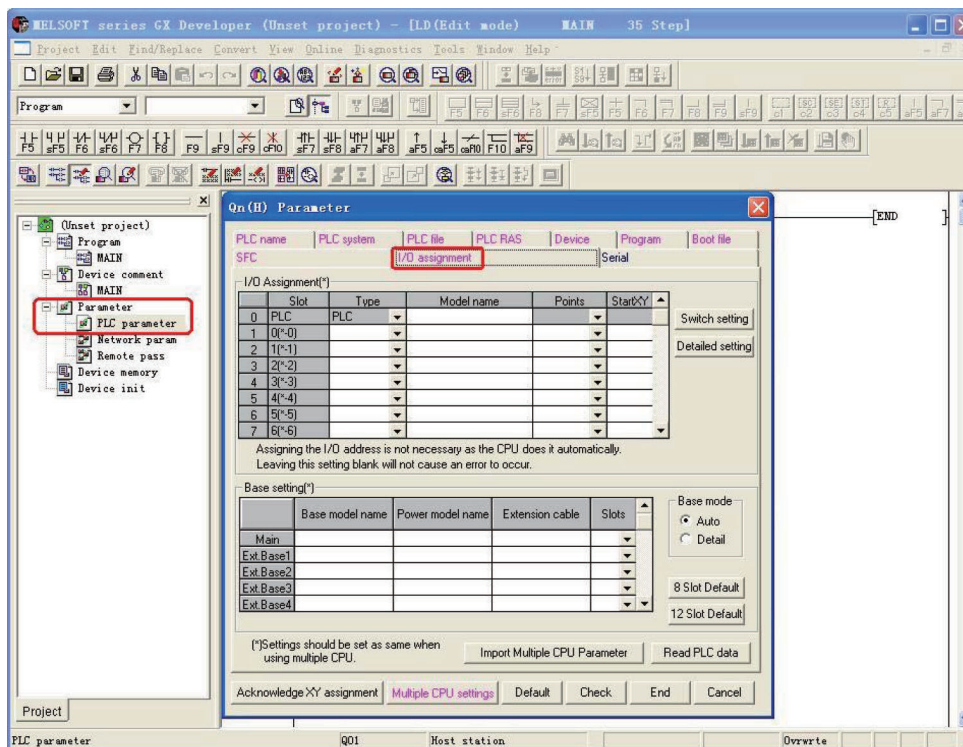

- 2 Click the [Type] dropdown list to select the [Intelli.] option.

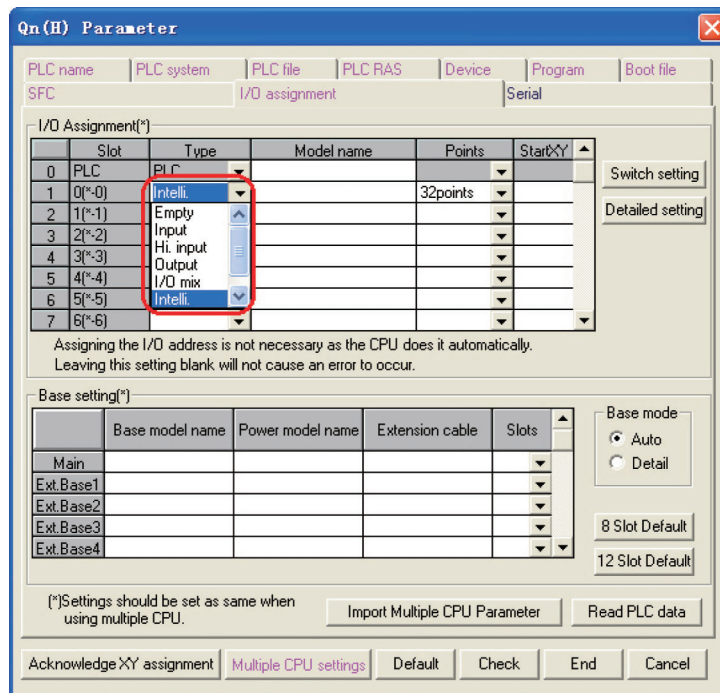

- 3 Click the [Switch setting] button and make settings as shown below:

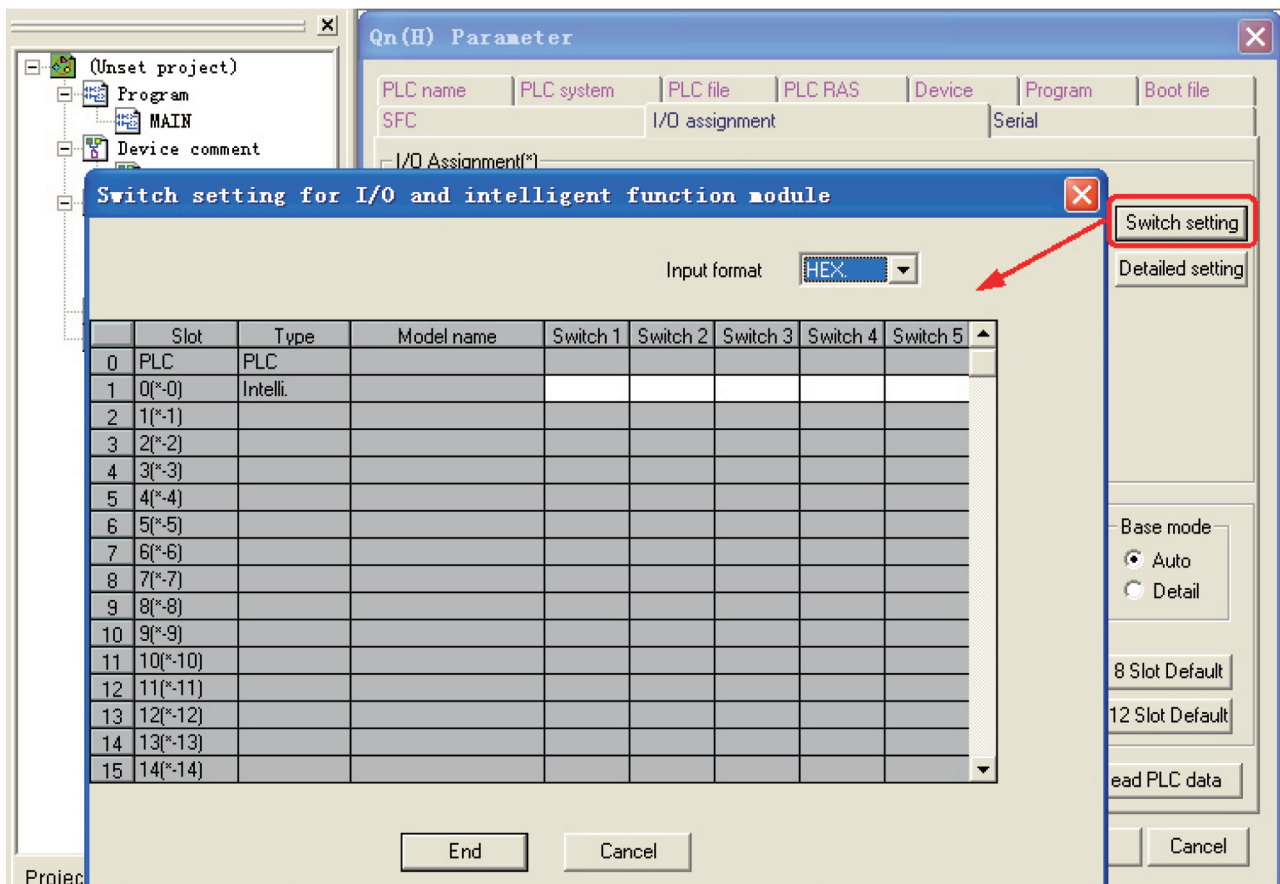

The attribute descriptions of Switch1, Switch2, Switch3, Switch4 and Switch5 are as shown below:

Switch	Content		[Example]				
Switch 1	CH1:Baud rate , transmission setting		0BEEH 115Kbps 8bit 1bit Even				
	Bit <span style="float:right">15</span> <span style="float:right">8 7</span> <span style="float:right">0</span> <div style="border: 1px solid black; width: 100px; height: 15px; margin: 5px auto; display: flex; justify-content: space-between;"> <span>Baud rate</span> <span>transmission setting</span> </div>						
	bps	Settings		Bit	Content	OFF	ON
	4800	04H		0	Action set	Independent	Linked
	9600	05H		1	Data bit	7	8
	19200	07H		2	Parity check bit	Reserved	Served
	38400	09H		3	Parity check	Odd	Even
57600	0AH	4	Stop bit	1	2		
115200	0BH	5	Sum check	Reserved	Served		
		6	Run write	disable	enable		
		7	Set to change	disable	enable		
Switch 2	CH1:Communication protocol	MC protocol Form 5 Binary code	0005H				
Switch 3	CH2:Baud rate,transmission setting (The same with the switch 1)		0BEEH				
Switch 4	CH2:Communication protocol	MC protocol Form 5 Binary code	0005H				
Switch 5	Set the station number	0~31	000H				

- Setting Example

The Switch3, Switch4 and Switch5 can be set as shown below if the CH2 RS422 communication parameters and Station No. are set to 19200/8/Odd/1 and 0 respectively:

Setting Switch	Setting Value	Setup Description
Switch 3	07E6	19200/8/With/Odd/1
Switch 4	0005	Mode = Form 5
Switch 5	0000	Station No. = 0

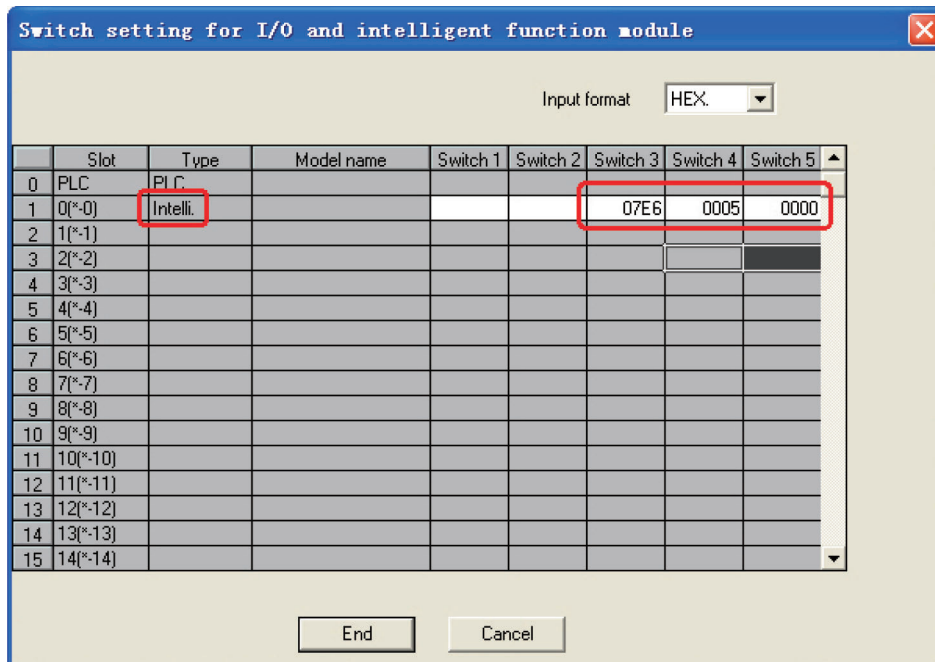



The Switch1, Switch2 and Switch5 can be set as shown below if the CH1 RS232 communication parameters and Station No. are set to 19200/8/Odd/1 and 0 respectively:

Setting Switch	Setting Value	Setup Description
Switch 1	07E6	19200/8/With/Odd/1
Switch 2	0005	Mode = Form 5
Switch 5	0000	Station No. = 0

The difference between **Mitsubishi Q\_QnA (Link Port)** protocol and **Mitsubishi Melsec Q** protocol:

- Mitsubishi Q\_QnA (Link Port) protocol features fast communication speed.
- Mitsubishi Melsec Q protocol features slow communication speed.

### 3-3-8 When Using Mitsubishi FX Series Ethernet(TCP Slave) Communication Protocol

#### PT Settings

The PT Network Settings are as shown below.

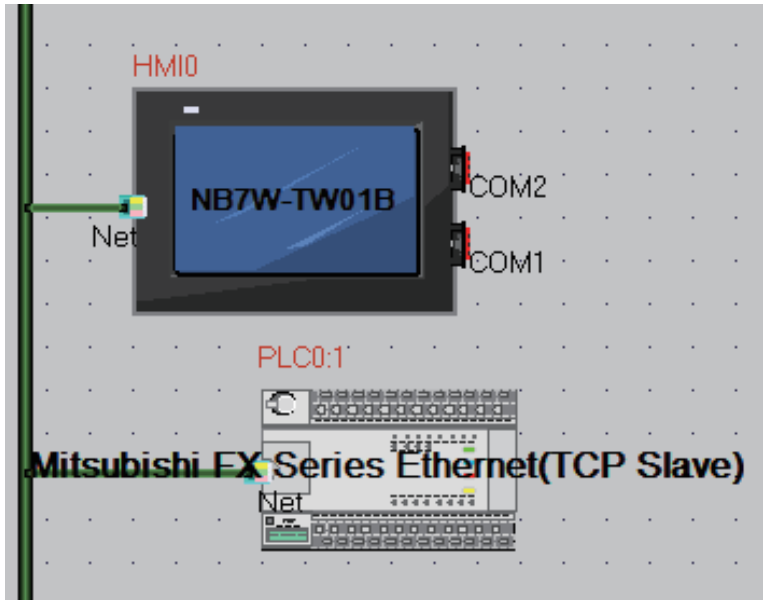

Network device setting

Device	IP Addr	Port	Protocol	Master/Sla...	Station ...	Virtual PLC...
HMI0	192.168.250.1	1025	Mitsubishi ...	M		
PLC0	192.168.250.2	1025	Mitsubishi ...	S	1	

Buttons: Add, Delete, Delete All, Modify, OK

## PLC Settings

The PLC Settings when using Communication Protocol of Mitsubishi FX Series Ethernet (TCP Slave) is as shown below.

### 1 Start-up Setting Tool, FX3U-ENET-L.

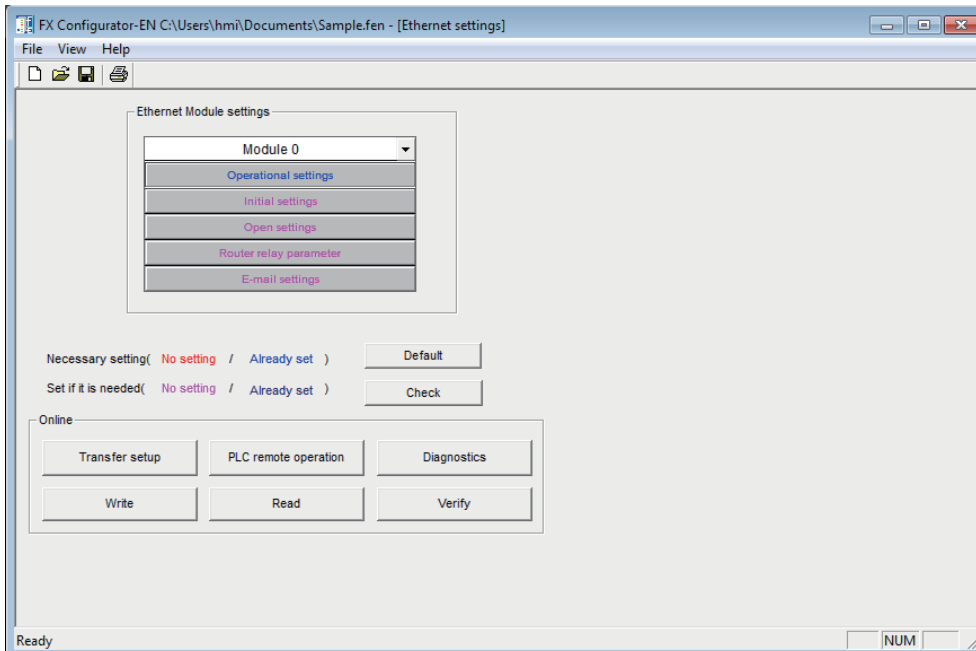

### 2 Click the [Operation Setting] to open [Ethernet Operation Setting].

Set the IP address to the same parameters as the PT settings.

Other settings should be the same as the dialog box as below.

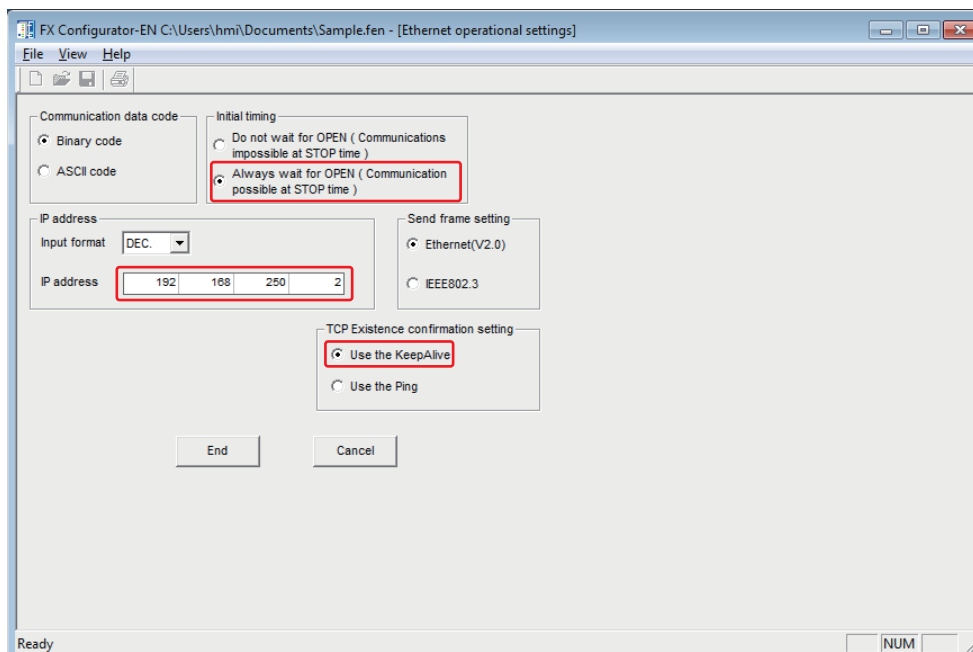

**3** Click the [Open Setting] to open the [Ethernet Open Setting].

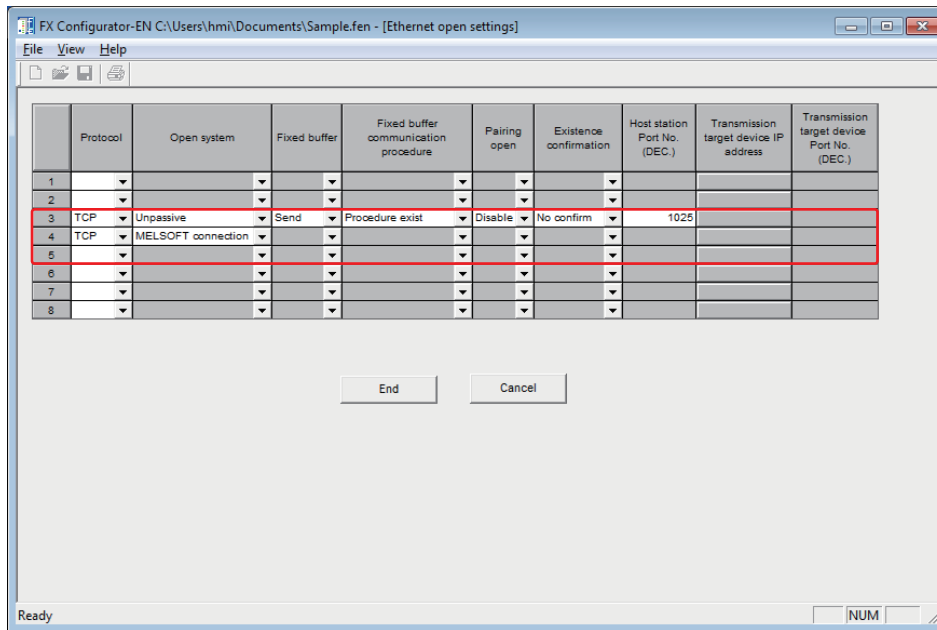

### 3-3-9 When Using Mitsubishi QnA 3EBin Ethernet (TCP Slave) Communication Protocol

#### PT Settings

The PT Network Settings are as shown below.

**Note** The Station No. is fixed to 255.

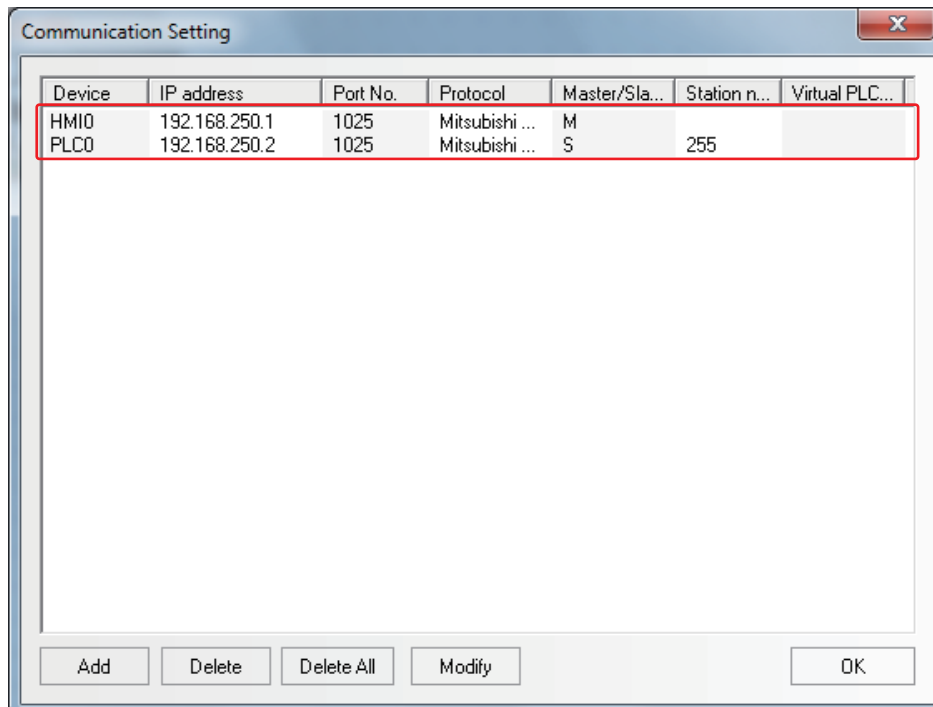
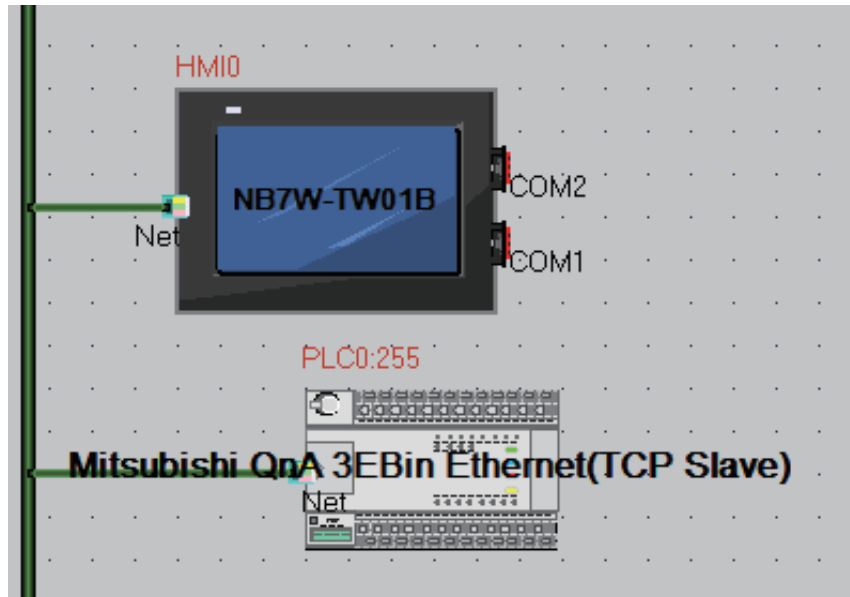

## PLC Settings

The PLC Settings when using Communication Protocol of Mitsubishi QnA 3EBin Ethernet (TCP Slave) is as shown below.

- 1 Double-click the [PLC Parameter] under [Project] of GX Works2 software.

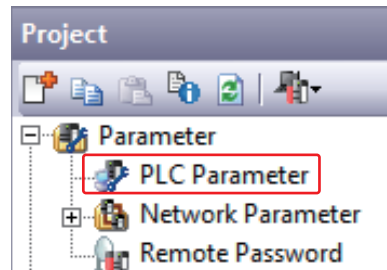

- 2 [Q Parameter Setting] or [L Parameter Setting] dialog boxes are open.

Set the IP address to the same parameters as the PT settings.

Other settings should be the same as the dialog box as below.

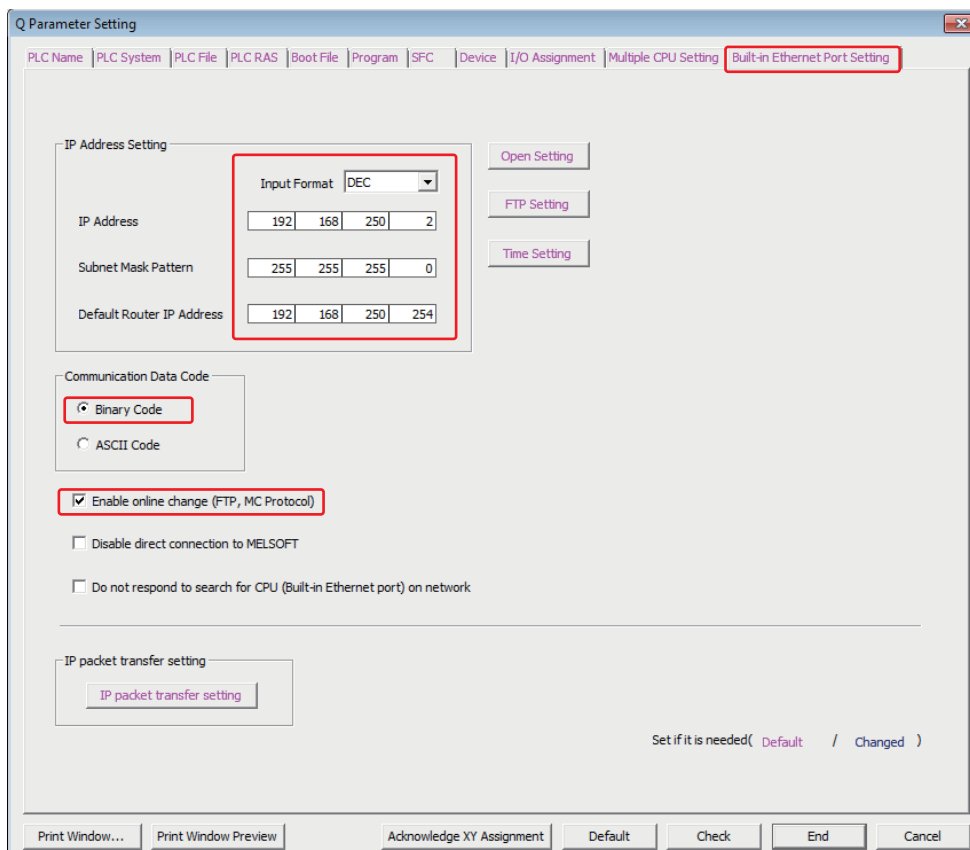

- 3 Click the [Open Setting] to open [Build-in Ethernet Port Open Setting] dialog box.  
Set the parameters as the same with the dialog box as follows.

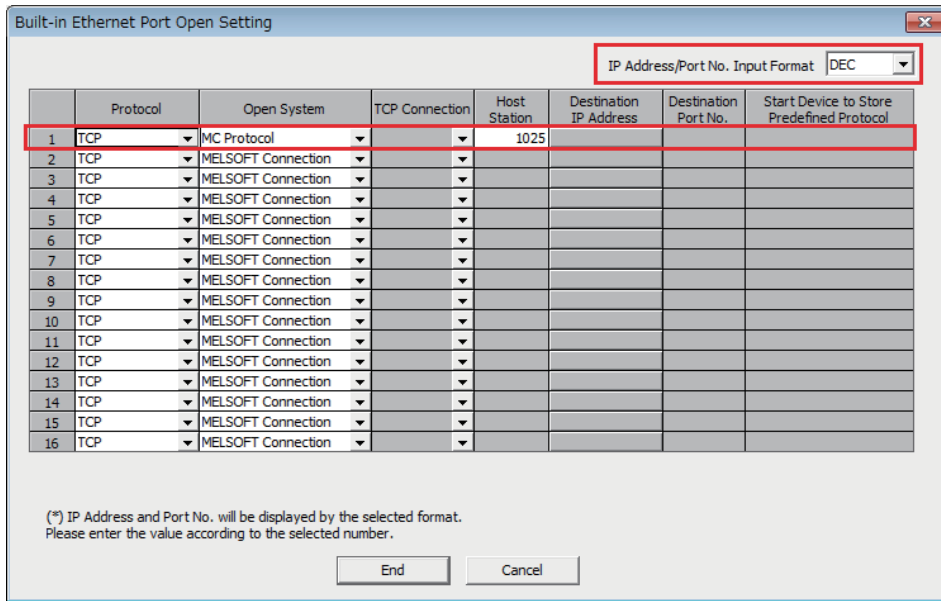

### 3-3-10 When Using Mitsubishi QJ71E71 EtherNet Slave Communication Protocol

#### PT Settings

The PT Network Settings are as shown below.

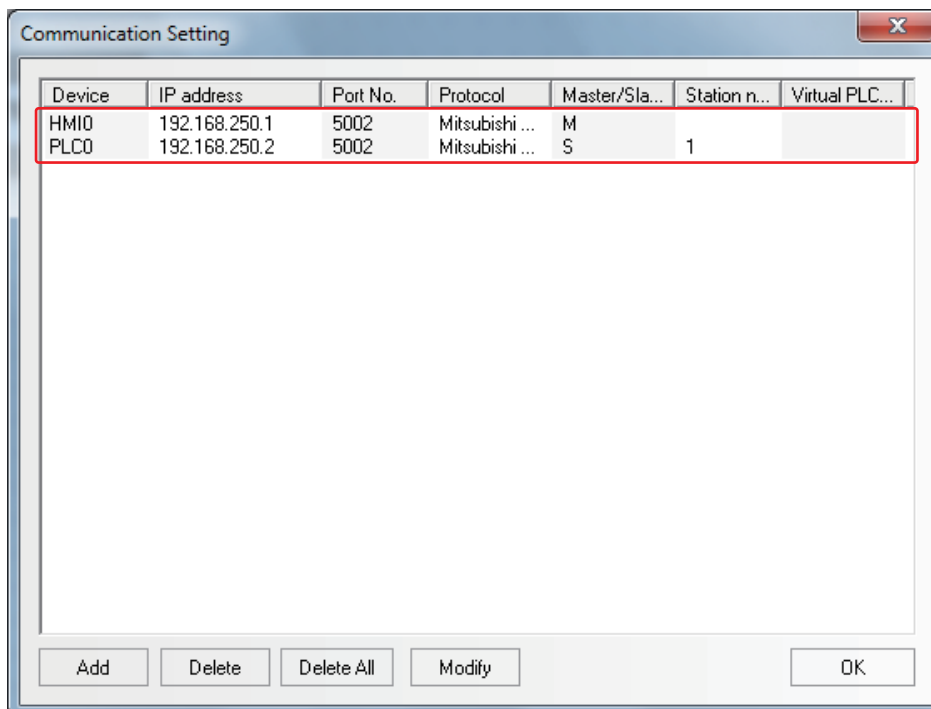
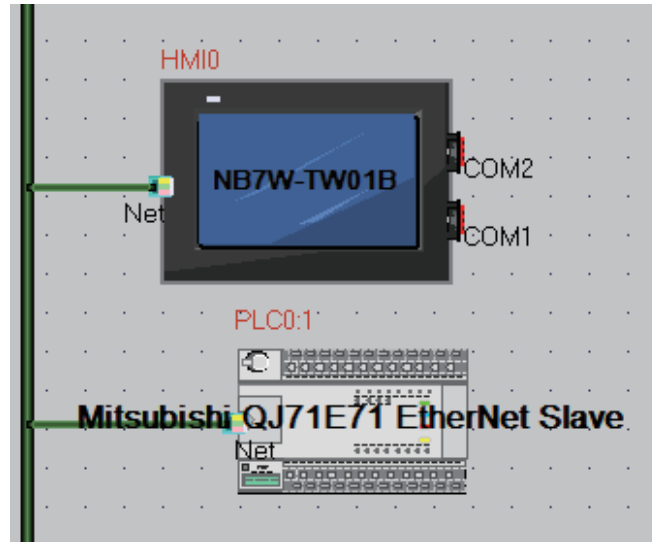



## PLC Settings

PLC Settings when using Mitsubishi QJ71E71 EtherNet Slave Communication Protocol are as shown below.

- 1 Double-click the [Ethernet/CC IE/MELSECNET] under [Project] of GX Works2 software.

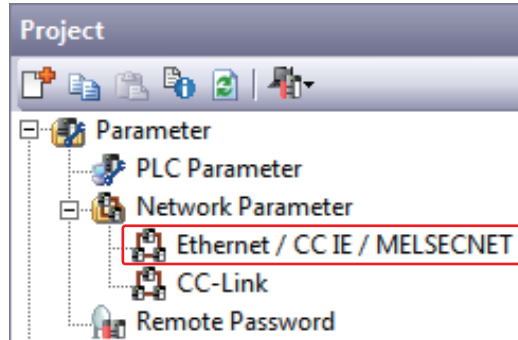

- 2 [Network Parameter] tab is opened.

Set the parameters as the same with the diagram as follows.

	Module 1	Module 2
Network Type	Ethernet	None
Start I/O No.	0000	
Network No.	1	
Total Stations		
Group No.	0	
Station No.	2	
Mode	Online	
	Operation Setting	
	Initial Setting	
	Open Setting	
	Router Relay Parameter	
	Station No. <-> IP Information	
	FTP Parameters	
	E-mail Setting	
	Interrupt Settings	

**Note** When connecting to NB, each parameter should be restricted to the ones as follows.

Start I/O No.: 0000  
 Network No.: 1  
 Group No.: 0  
 Station No.: 2 to 64  
 Mode: Online

- 3** Click the [Operation Setting] to open [Ethernet Operation Setting].  
Set the IP address to the same parameters as the PT settings.  
Other settings should be the same as the dialog box as below.

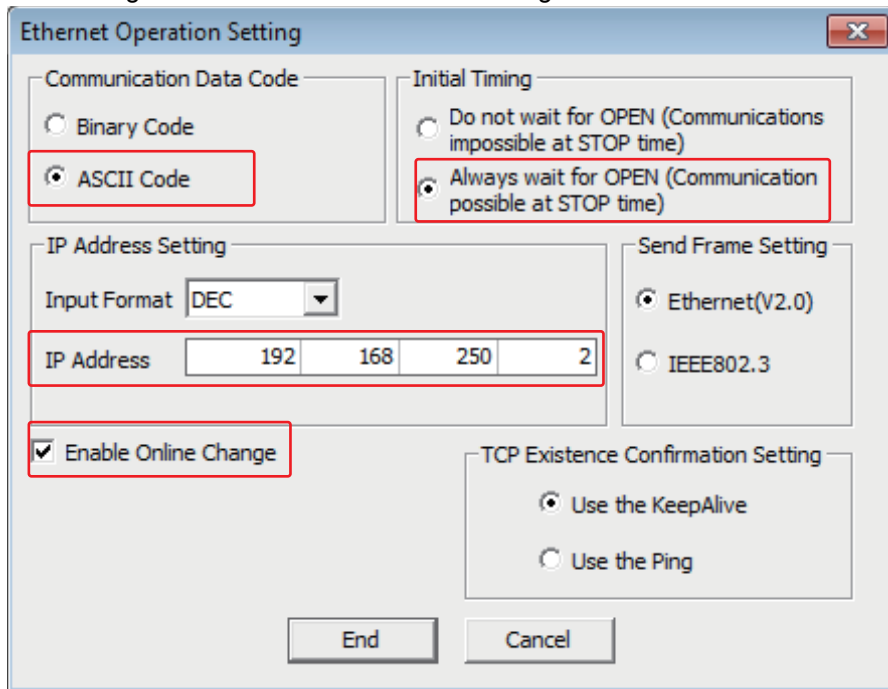

- 4** Click the [Open Setting] to open the [Ethernet Open Setting] tab.  
Select TCP in [Protocol] and MELSOFT Connection in [Open System], respectively.

## 3-4 Supported Registers



### Precautions for Correct Use

The operation is not guaranteed when the area that does not exist physically is accessed.



### Additional Information

Address format description: D: decimal, O: octal, H: hexadecimal.

#### Mitsubishi FX1S Driver

Device	Bit Address	Word Address	Format	Notes
Input Relay	X 0-17	-----	OO	
Output Relay	Y 0-15	-----	OO	
Internal Relay	M 0-511	-----	DDD	
Timer Contact	T 0-63	-----	DD	
Counter Contact	C 0-31	-----	DD	
Data Contact	D_bit 0.0-255.F	-----	DDD.H	
State	S 0-127	-----	DDD	
Timer Value	-----	T_word 0-63	DD	
Counter Value	-----	C_word 0-31	DD	
Data Register	-----	D_word 0-255	DDD	
Special Data Register	-----	SD_word 8000-8255	DDDD	
Counter Value	-----	C_dword 235-255	DDD	32 bit device

#### Mitsubishi FX1N/2N/3GS Driver

Device	Bit Address	Word Address	Format	Notes
Input Relay	X 0-377	-----	OOO	
Output Relay	Y 0-377	-----	OOO	
Internal Relay	M 0-3071	-----	DDDD	
Timer Contact	T_bit 0-255	-----	DDD	
Counter Contact	C_bit 0-199	-----	DDD	
Special Internal Relay	SM 8000-8255	-----	DDDD	
State	S 0-999	-----	DDD	
Timer Value	-----	T_word 0-255	DDD	
Counter Value	-----	C_word 0-199	DDD	
Data Register	-----	D 0-7999	DDDD	
Special Data Register	-----	SD 8000-8255	DDDD	
Counter Value	-----	C_dword 200-255	DDD	32 bit device

## Mitsubishi FX2N-10GM/20GM Driver

Device	Bit Address	Word Address	Format	Notes
Input Relay	X 0-571	-----	OOO	*1
Output Relay	Y 0-571	-----	OOO	*1
Internal Relay	M 0-7999	-----	DDDD	*1
Special Internal Relay	SM 9000-9999	-----	DDDD	*1
Data Register	-----	D 0-7999	DDDD	*2
Special Data Register	-----	SD 9000-9999	DDDD	*2
Special Data Register	-----	FD 4000-4550	DDDD	*2
Present position	-----	CP_unit 0-1	D	D9004-9005 D9014-9015
Present position (converted into pulses)	-----	CP_puls 0-1	D	D9074-9075 D9094-9095

\*1 does not support batch transmission while

\*2 supports batch transmission.

## Mitsubishi FX3U Driver

Device	Bit Address	Word Address	Format	Notes
Input Relay	X 0-764	-----	OOO	
Output Relay	Y 0-764	-----	OOO	
Timer Contact	T_bit 0-511	-----	DDD	
Counter Contact	C_bit 0-255	-----	DDD	
Data Contact	D_bit 0.0-7999.F	-----	DDDD.H	
State	S 0-4095	-----	DDDD	
Internal Relay	M 0-7999	-----	DDDD	*1
Special Internal Relay	SM 8000-9999	-----	DDDD	
Timer Value	-----	T_word 0-511	DDD	
Counter Value	-----	C_word 0-199	DDD	
Data Register	-----	D_word 0-17999	DDDDD	
Extension Register	-----	R 0-32767	DDDDD	
Special Data Register	-----	SD 8000-9999	DDDD	
Counter Value	-----	C_dword 200-255	DDD	32 bit device

\*1 The operations accessed beyond the limit is not guaranteed.

## Mitsubishi FX-485ADP/485BD/232BD (Multi-station) Driver

Device	Bit Address	Word Address	Format	Notes
Input Relay	X 0-571	-----	OOO	
Output Relay	Y 0-571	-----	OOO	
Timer Contact	T_bit 0-511	-----	DDD	
Counter Contact	C_bit 0-255	-----	DDD	
State	S 0-4095	-----	DDDD	
Internal Relay	M 0-7679	-----	DDDD	
Special Internal Relay	SM 8000-8511	-----	DDDD	
Timer Value	-----	T_word 0-511	DDD	
Counter Value	-----	C_word 0-255	DDD	
Data Register	-----	D 0-7999	DDDD	
File Register	-----	R 0-32767	DDDDD	
Special Data Register	-----	SD 8000-8511	DDDD	
Counter Value	-----	C_dword 0-2047	DDDD	32 bit device

## Mitsubishi Q00J (CPU Port) Driver

Device	Bit Address	Word Address	Format	Notes
Counter Coil	CC 0-1023		DDDD	
Counter Contact	CS 0-1023		DDDD	
Timer Coil	TC 0-2047		DDDD	
Timer Contact	TS 0-2047		DDDD	
Special Link Relay	SB 0-7FFF	-----	HHHH	
Link Relay	B 0-7FFF	-----	HHHH	
Step Relay	S 0-1FFF	-----	HHHH	
Edge Relay	V 0-32767	-----	DDDDD	
Annunciator	F 0-32767	-----	DDDDD	
Latch Relay	L 0-32767	-----	DDDDD	
Special Internal Relay	SM 0-2047	-----	DDDD	
Internal Relay	M 0-32767	-----	DDDDD	
Output Relay	Y 0-1FFF	-----	HHHH	
Input Relay	X 0-1FFF	-----	HHHH	
File Register	-----	R 0-32767	DDDDD	
Special Link Register		SW 0-7FF	HHH	
Link Register	-----	W 0-291F	HHHH	
Special Data Register	-----	SD 0-2047	DDDD	
Data Register	-----	D 0-25983	DDDDD	
Counter Value	-----	CN 0-23087	DDDDD	
Retentive Timer Value	-----	SN 0-2047	DDDD	
Timer Value	-----	TN 0-23087	DDDDD	

## Mitsubishi Q\_QnA (Link Port) Driver

Device	Bit Address	Word Address	Format	Notes
Special Link Relay	SB 0- 7FFF	-----	HHHH	
Link Relay	B 0- 7FFF	-----	HHHH	
Step Relay	S 0-8191	-----	DDDD	
Edge relay	V 0-32767	-----	DDDDD	
Annunciator	F 0-32767	-----	DDDDD	
Latch relay	L 0-32767	-----	DDDDD	
Special Internal Relay	SM 0-2047	-----	DDDD	
Internal Relay	M 0-32767	-----	DDDDD	
Output Relay	Y 0-1FFF	-----	HHHH	
Input Relay	X 0-1FFF	-----	HHHH	
Link Register	-----	W 0- 291F	HHHH	
Timer Value	-----	TN 0-23087	DDDDD	
Counter Value	-----	CN 0-23087	DDDDD	
Index Register	-----	Z 0-19	DD	
File Register	-----	R 0-32767	DDDDD	
Retentive Timer Value	-----	SN 0-23087	DDDDD	
Special Link Register	-----	SW 0- 7FF	HHH	
File Register (Block switching is not necessary)	-----	ZR 0-65535	DDDDD	
Data Register	-----	D 0-25983	DDDDD	
Special Data Register	-----	SD 0-2047	DDDD	

## Mitsubishi Q series (CPU Port) Driver

Device	Bit Address	Word Address	Format	Notes
Special Link Relay	SB 0-7FFF	-----	HHHH	
Link Relay	B 0-7FFF	-----	HHHH	
Edge Relay	V 0-32767	-----	DDDDD	
Annunciator	F 0-32767	-----	DDDDD	
Latch Relay	L 0-32767	-----	DDDDD	
Special Internal Relay	SM 0-2047	-----	DDDD	
Internal Relay	M 0-32767	-----	DDDDD	
Output Relay	Y 0-1FFF	-----	HHHH	
Input Relay	X 0-1FFF	-----	HHHH	
Step Relay	S 0 -8191	-----	DDDD	
Link Register	-----	W 0-291F	HHHH	
Timer Value	-----	TN 0-23087	DDDDD	
Counter Value	-----	CN 0-23087	DDDDD	
File Register	-----	R 0-32767	DDDDD	
Special Link Register	-----	SW 0-7FF	HHH	
Data Register	-----	D 0-25983	DDDDD	
Special Data Register	-----	SD 0-2047	DDDD	
Index Register	-----	Z 0-19	DD	
File Register (Block switching is not necessary)	-----	ZR 0-4184063	DDDDDDD	*1
Retentive Timer Value	-----	SN 0-23087	DDDDD	

\*1 Supports only Q06UDH.

## Mitsubishi Q06H Driver

Device	Bit Address	Word Address	Format	Notes
Special Link Relay	SB 0-7FFF	-----	HHHH	
Link Relay	B 0-7FFF	-----	HHHH	
Edge Relay	V 0-32767	-----	DDDDD	
Annunciator	F 0-32767	-----	DDDDD	
Latch Relay	L 0-32767	-----	DDDDD	
Special Internal Relay	SM 0-2047	-----	DDDD	
Internal Relay	M 0-32767	-----	DDDDD	
Output Relay	Y 0-1FFF	-----	HHHH	
Input Relay	X 0-1FFF	-----	HHHH	
Link Register	-----	W 0-291F	HHHH	
Timer Value	-----	TN 0-23087	DDDDD	
Counter Value	-----	CN 0-23087	DDDDD	
File Register	-----	R 0-32767	DDDDD	
Special Link Register	-----	SW 0-7FF	HHH	
Data Register	-----	D 0-25983	DDDDD	
Special Data Register	-----	SD 0-2047	DDDD	

## Mitsubishi FX Series Ethernet (TCP Slave)

Device	Bit Address	Word Address	Format	Notes
Input Relay	X 0-255	-----	OOO	
Output Relay	Y 0-255	-----	OOO	
Timer Contact	T_bit 0-511	-----	DDD	
Counter Contact	C_bit 0-255	-----	DDD	
Data Contact	D_bit 0-127999	-----	DDDDD	
State	S 0-4095	-----	DDDD	
Internal Relay	M 0-7679	-----	DDDD	*1
Special Internal Relay	SM 8000-8511	-----	DDDD	
Timer Value	-----	T_word 0-511	DDD	
Counter Value	-----	C_word 0-199	DDD	
Data Register	-----	D_word 0-7999	DDDD	
Extension Register	-----	R 0000-32767	DDDDD	
Special Data Register	-----	SD 8000-8511	DDDD	
Counter Value	-----	C_dword 200-255	DDD	32 bit device

\*1 The operations accessed beyond the limit is not guaranteed.

## Mitsubishi QnA 3EBin Ethernet (TCP Slave) Driver

Device	Bit Address	Word Address	Format	Notes
Input Relay	X 0-3FFF	-----	HHHH	
Output Relay	Y 0-3FFF	-----	HHHH	
Direct Input	DX 0- 1FFF	-----	HHHH	
Direct Output	DY 0- 1FFF	-----	HHHH	
Internal Relay	M 0-61439	-----	DDDDD	
Special Internal Relay	SM 0-2255	-----	DDDD	
Latch Relay	L 0-32767	-----	DDDDD	
Annunciator	F 0-32767	-----	DDDDD	
Edge Relay	V 0-2047	-----	DDDDD	
Link Relay	B 0- EFFF	-----	HHHH	
Timer Contact	TS 0-32767	-----	DDDDD	
Timer Coil	TC 0-32767	-----	DDDDD	
Accumulated Timer (contact)	SS 0-32767	-----	DDDDD	
Accumulated Timer (coil)	SC 0-32767	-----	DDDDD	
Counter Contact	CS 0-32767	-----	DDDDD	
Counter Coil	CC 0-32767	-----	DDDDD	
Special Link Relay	SB 0-7FFF	-----	HHHH	
Step Relay	S 0-32767	-----	DDDDD	
Data Register	-----	D 0-61439	DDDDD	
Special Data Register	-----	SD 0-2255	DDDD	
Link Register	-----	W 0- EFFF	HHHH	
Special Link Register	-----	SW 0-7FFF	HHHH	
Timer Value	-----	TN 0-32767	DDDDD	
Accumulated Timer (present value (PV))	-----	SN 0-32767	DDDDD	

Device	Bit Address	Word Address	Format	Notes
Counter Value	-----	CN 0-32767	DDDDD	
Index Register	-----	Z 0-19	DD	
File Register	-----	R 0-32767	DDDDD	
File Register (Block switching is not necessary)	-----	ZR 0-4849663	DDDDDDD	
Special Link Resister	-----	SB 0-7FF0	HHHH	
Link Resister	-----	B 0-EFF0	HHHH	
Input	-----	X 0-3FF0	HHHH	
Output	-----	Y 0-3FF0	HHHH	

## Mitsubishi QJ71E71 Ethernet (TCP Slave) Driver

Device	Bit Address	Word Address	Format	Notes
Input Relay	X 0-2000	-----	HHHH	
Output Relay	Y 0-2000	-----	HHHH	
Internal Relay	M 0-32768	-----	DDDDD	
Special Internal Relay	SM 0-2048	-----	DDDD	
Latch Relay	L 0-32768	-----	DDDDD	
Annunciator	F 0-32768	-----	DDDDD	
Edge Relay	V 0-32768	-----	DDDDD	
Link Relay	B 0-8000	-----	HHHH	
Timer Contact	TS 0-23088	-----	DDDDD	
Timer Coil	TC 0-23088	-----	DDDDD	
Accumulated Timer (contact)	SS 0-23088	-----	DDDDD	
Accumulated Timer (coil)	SC 0-23088	-----	DDDDD	
Counter Contact	CS 0-23088	-----	DDDDD	
Counter Coil	CC 0-23088	-----	DDDDD	
Special Link Relay	SB 0-8000	-----	HHHH	
Step Relay	S 0-8192	-----	DDDD	
Data Register	-----	D 0-25984	DDDDD	
Special Data Register	-----	SD 0-2048	DDDD	
Link Register	-----	W 0- 2920	HHHH	
Special Link Register	-----	SW 0-800	HHH	
Timer Value	-----	TN 0-23088	DDDDD	
Accumulated Timer (present value (PV))	-----	SN 0-23088	DDDDD	
Counter Value	-----	CN 0-23088	DDDDD	
File Register	-----	R 0-32768	DDDDD	
File Register (Block switching is not necessary)	-----	ZR 0-1042432	DDDDDDD	



## 3-5 Cable Fabrication

### FX Series RS232 Communication Cable

- FX□□-232-BD Communication Cable

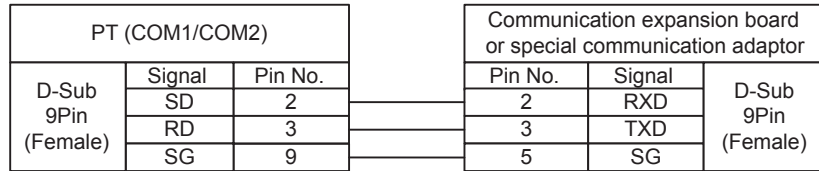

### FX Series RS485/422 Communication Cable

- Communication Cable for CPU Port/FX□□-422-BD Communication Cable

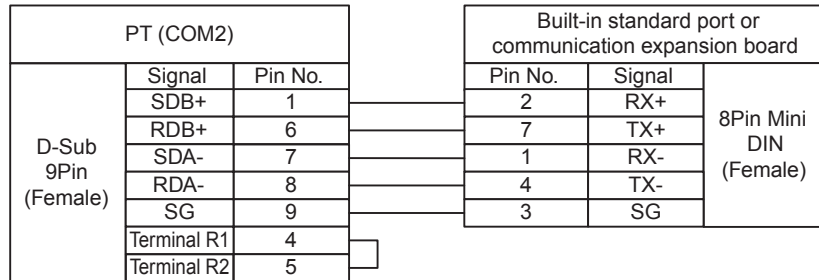

- FX□□-485-BD/FX□□-485 ADP Communication Cable

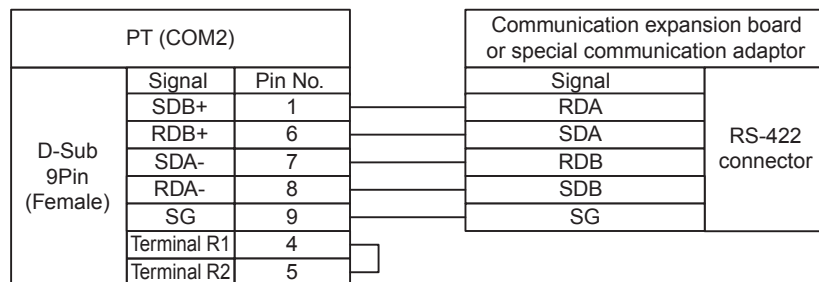

## Q Series RS232 Communication Cable

### ● Communication Cable for CPU Port (Except Q00UJ CPU and L02S CPU)

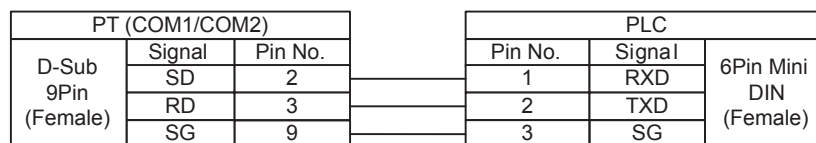

### ● Communication Cable for CPU Port (Q00UJ CPU and L02S CPU)

For the communication with the PT, use RS-232 cable (QC30R2) to connect the PC - sequencer CPU manufactured by Mitsubishi Electric.

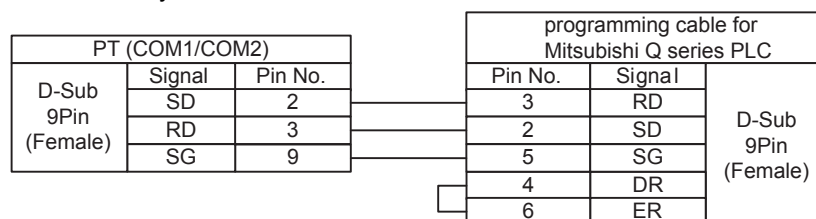

### ● RS232 communication cable for C24 Serial Communication Module

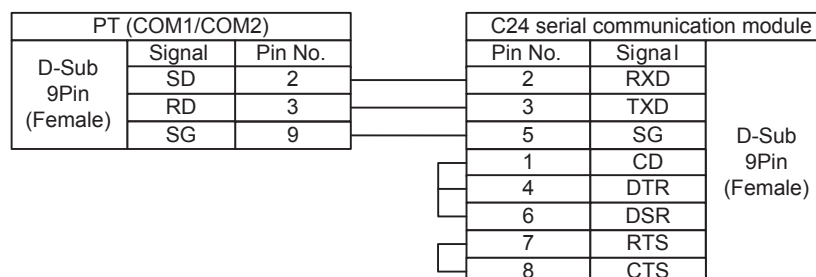

## Q-Series RS485/422 Communication Cable

### ● RS422 Communication Cable for C24 Serial Communication Module

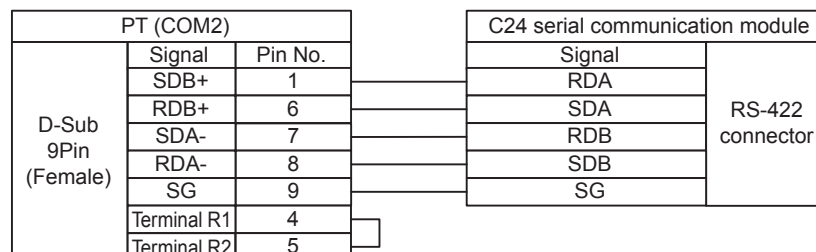

## Ethernet Communication Cable

Use Twisted Pair Cable to connect. Refer to *Ethernet communication specifications* in A-1-3 *Communication Specifications* in the *NB-series Programmable Terminals Setup Manual* (Cat. No. V107).

# 4

## Connecting to Schneider PLCs

This section describes the connection to Schneider PLCs.

---

<b>4-1</b>	<b>Serial Port Communication</b>	<b>4-2</b>
<b>4-2</b>	<b>Communication Parameters and Cable Fabrication</b>	<b>4-3</b>
<b>4-3</b>	<b>Communication Parameter Setting</b>	<b>4-4</b>
<b>4-4</b>	<b>Supported Registers</b>	<b>4-13</b>
<b>4-5</b>	<b>Cable Fabrication</b>	<b>4-14</b>

## 4-1 Serial Port Communication

Series	CPU	Link Module	Driver
Micro	TSX3705001 TSX 37 05 028DR1 TSX 37 08 056DR1 TSX 37 10 128DT1 TSX 37 10 128DR1 TSX 37 10 128DTK1 TSX 37 10 164DTK1 TSX 37 10 028AR1 TSX 37 10 028DR1 TSX 37 21 101 TSX 37 22 101 TSX 37 21 001 TSX 37 22 001	TER port on the CPU	Schneider Modicon Uni-TelWay Modbus RTU
Premium	TSX P57 103M TSX P57 153M TSX P57 203M TSX P57 253M TSX P57 303M TSX P57 353M TSX P57 453M	TER port on the CPU	
Nano	TSX 07 3L □□□□28 TSX 07 30 10□□□□ TSX 07 31 16□□□□ TSX 07 31 24□□□□ TSX 07 32 □□□□28 TSX 07 33 □□□□28	Programming port on CPU	
Twido	TWD LCAA 10DRF TWD LCAA 16DRF TWD LCAA 24DRF TWD LMDA 20DTK TWD LMDA 20DUK TWD LMDA 20DRT TWD LMDA 40DTK TWD LMDA 40DUK	RS485 on the CPU unit	Schneider Twido Modbus RTU

## 4-2 Communication Parameters and Cable Fabrication

Series	CPU	Link Module	Driver	COMM Type	Parameter	Cable
Modicon TSX	TSX3705001 TSX3705001 TSX 37 05 028DR1 TSX 37 08 056DR1 TSX 37 10 128DT1 TSX 37 10 128DR1 TSX 37 10 128DTK1 TSX 37 10 164DTK1 TSX 37 10 028AR1 TSX 37 10 028DR1 TSX 37 21 101 TSX 37 22 101 TSX 37 21 001 TSX 37 22 001	RS485 on the CPU unit	Schneider Modicon Uni-TelWay	RS232	Refer to Section 4-3	Self-made cable required
	RS485					
	TSX3705001 TSX3705001 TSX 37 05 028DR1 TSX 37 08 056DR1 TSX 37 10 128DT1 TSX 37 10 128DR1 TSX 37 10 128DTK1 TSX 37 10 164DTK1 TSX 37 10 028AR1 TSX 37 10 028DR1 TSX 37 21 101 TSX 37 22 101 TSX 37 21 001 TSX 37 22 001	RS485 on the CPU unit	Modbus RTU	RS232		
	RS485					
Twido	TWD LCAA 10DRF TWD LCAA 16DRF TWD LCAA 24DRF TWD LMDA 20DTK TWD LMDA 20DUK TWD LMDA 20DRT TWD LMDA 40DTK TWD LMDA 40DUK	RS485 on the CPU unit	Schneider Twido Modbus RTU	RS232		
				RS485		

## 4-3 Communication Parameter Setting

### PT Settings

- **When Using Schneider Modicon Uni-TelWay Protocol**

PT default communication parameters: 19200bps (Baud Rate), 8 (Data Bit), odd (Parity Check), 1 (Stop Bit) and 4 (PLC Station No.)

RS232 Communication

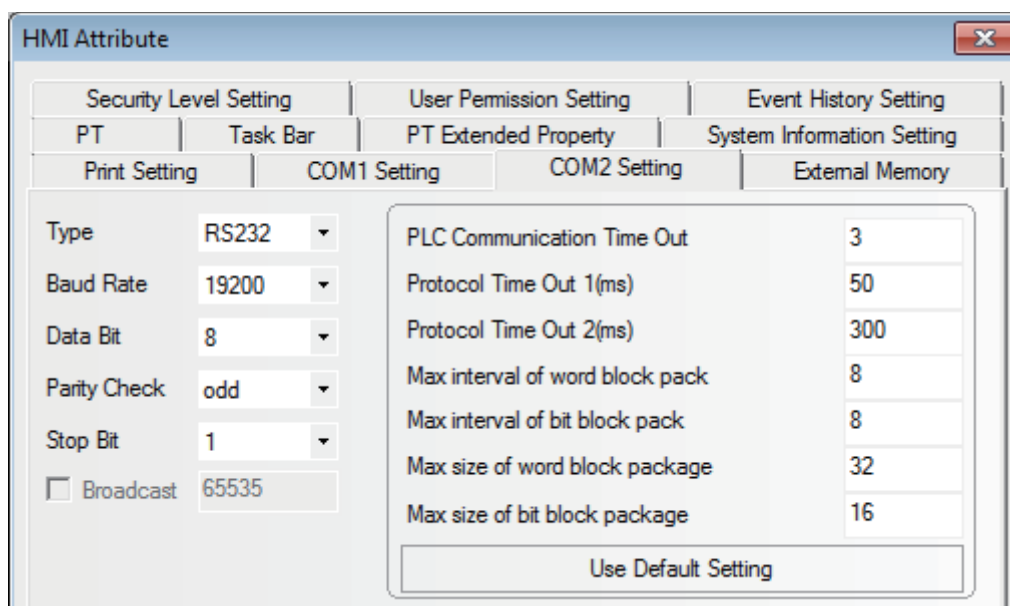

RS485 Communication

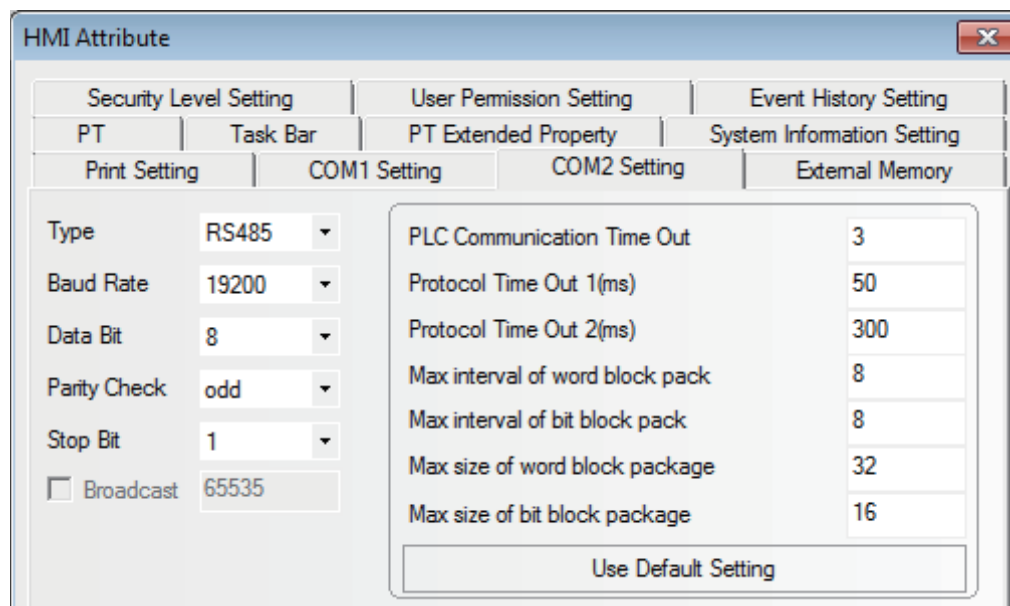

### ● When Using Modbus RTU Protocol

PT default communication parameters: 9600bps (Baud Rate), 8 (Data Bit), even (Parity Check), 1 (Stop Bit) and 1 (PLC Station No.)

RS232 Communication

The screenshot shows the 'HMI Attribute' dialog box with the 'COM1 Setting' tab selected. The 'Type' is set to 'RS232'. The communication parameters are: Baud Rate: 9600, Data Bit: 8, Parity Check: even, Stop Bit: 1, and Broadcast: 0. The right-hand table lists the following parameters and their values:

PLC Communication Time Out	3
Protocol Time Out 1(ms)	3
Protocol Time Out 2(ms)	3
Max interval of word block pack	2
Max interval of bit block pack	8
Max size of word block package	16
Max size of bit block package	64

A 'Use Default Setting' button is located at the bottom of the table.

RS485 Communication

The screenshot shows the 'HMI Attribute' dialog box with the 'COM1 Setting' tab selected. The 'Type' is set to 'RS485'. The communication parameters are: Baud Rate: 9600, Data Bit: 8, Parity Check: even, Stop Bit: 1, and Broadcast: 0. The right-hand table lists the following parameters and their values:

PLC Communication Time Out	3
Protocol Time Out 1(ms)	3
Protocol Time Out 2(ms)	3
Max interval of word block pack	2
Max interval of bit block pack	8
Max size of word block package	16
Max size of bit block package	64

A 'Use Default Setting' button is located at the bottom of the table.

## PLC Settings

### ● PL7 Software Setting

- 1 Open "Programs" menu - Select [XWAY Driver Manager] from Modicon Telemecanique:

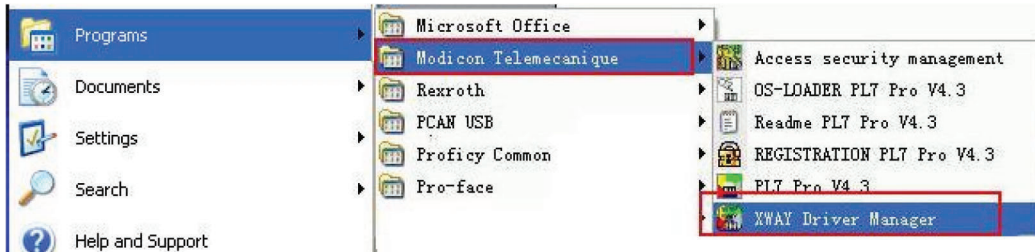

- 2 Select [UNITELWAY Driver] tab and push [Configuration] in the dialog box and finally select [Edit] in the following dialog box to modify the related settings of the communications.

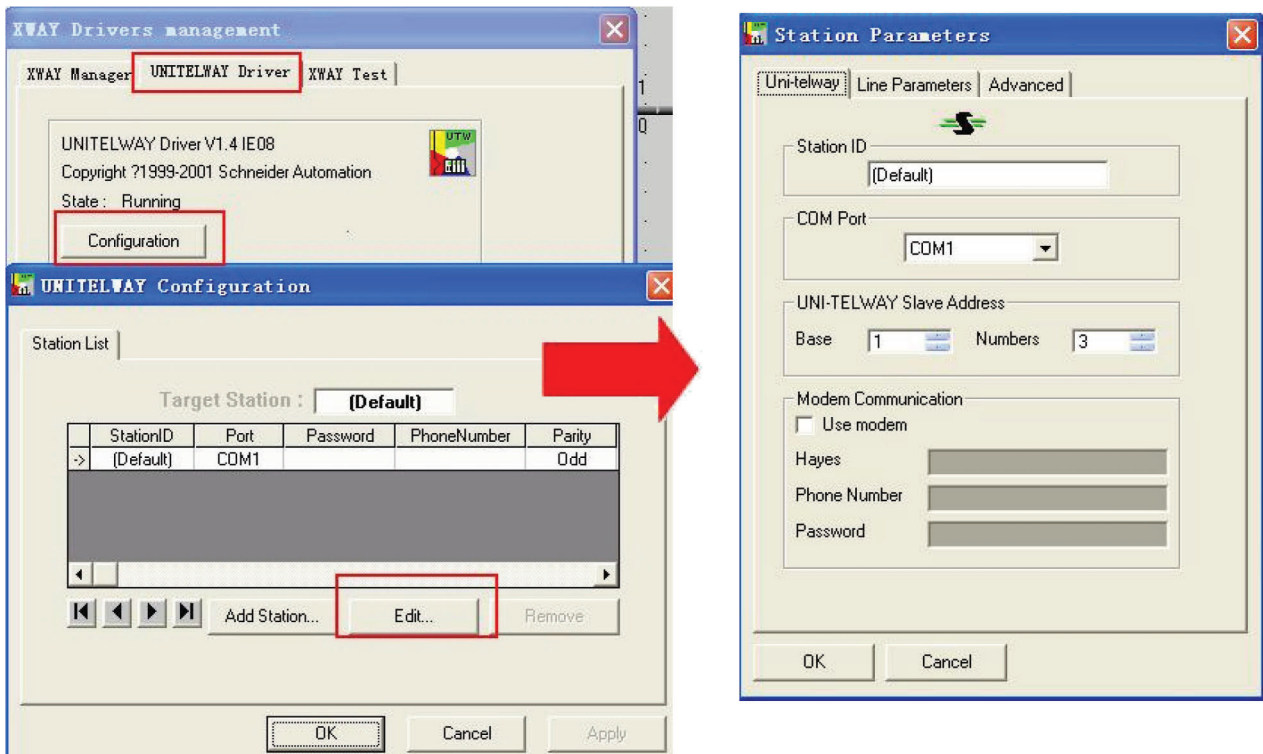



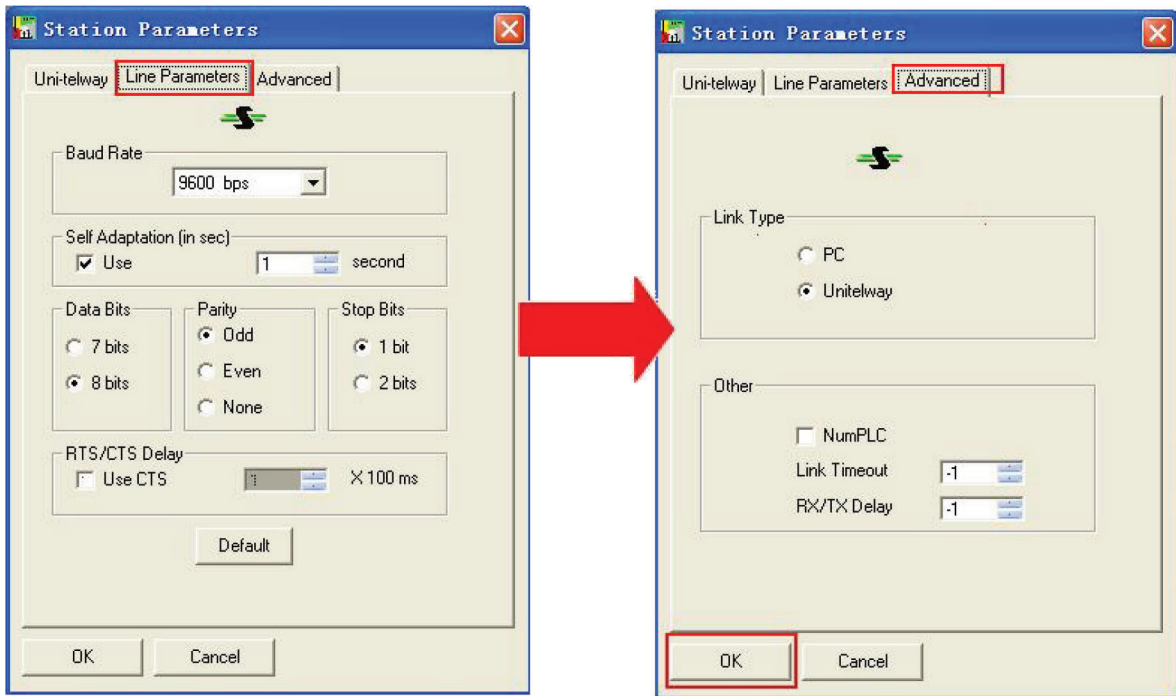

**3** The following prompt information will appear after the [OK] button is clicked:

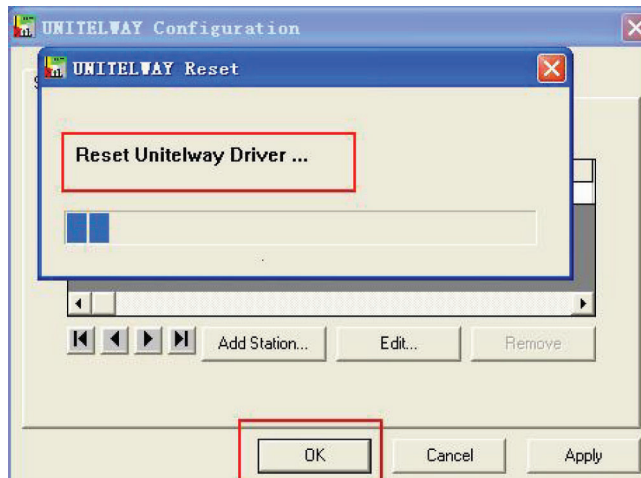

- 4 Click [XWAY Test]→[Connect] and the Connected prompt information will appear when the connection is successful.

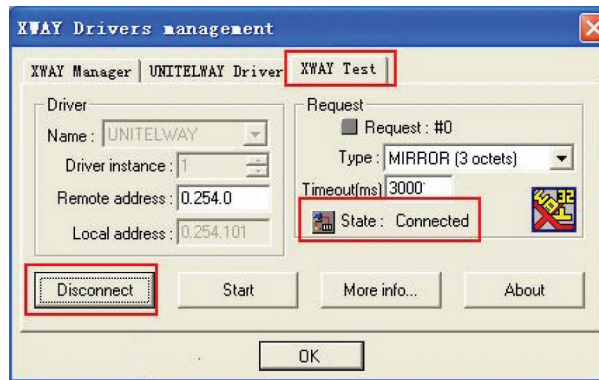

- 5 Open PL7 Software→New→Click [Hardware Configuration] in [STATION]→Double-click [comm] in popup window.

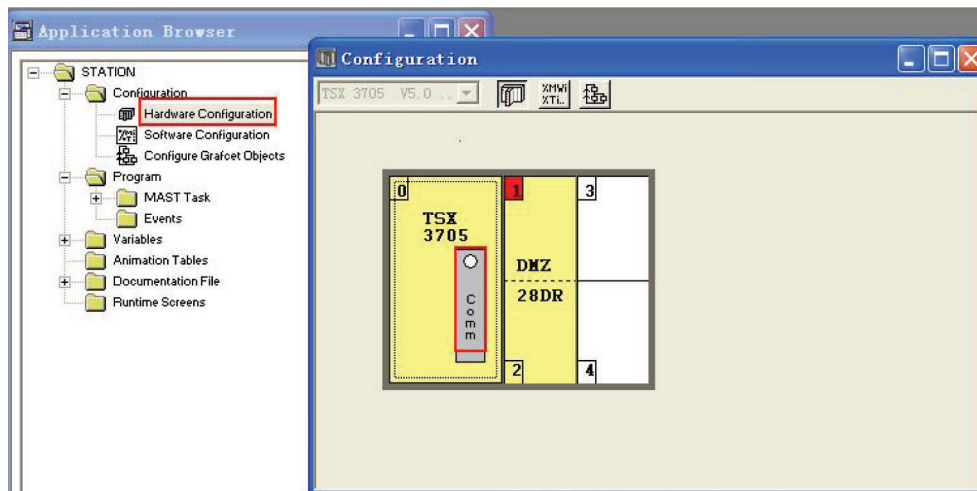

The settings are as shown below if Schneider Modicon Uni-TelWay Protocol is used:

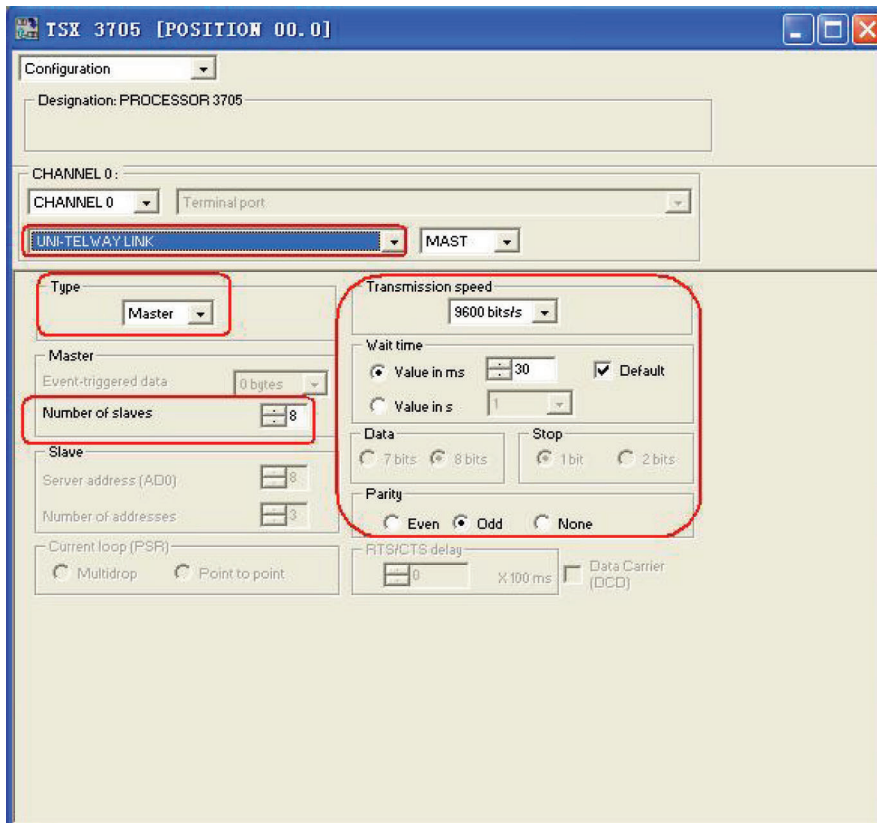

The settings are shown as below if Modbus RTU Protocol is used:

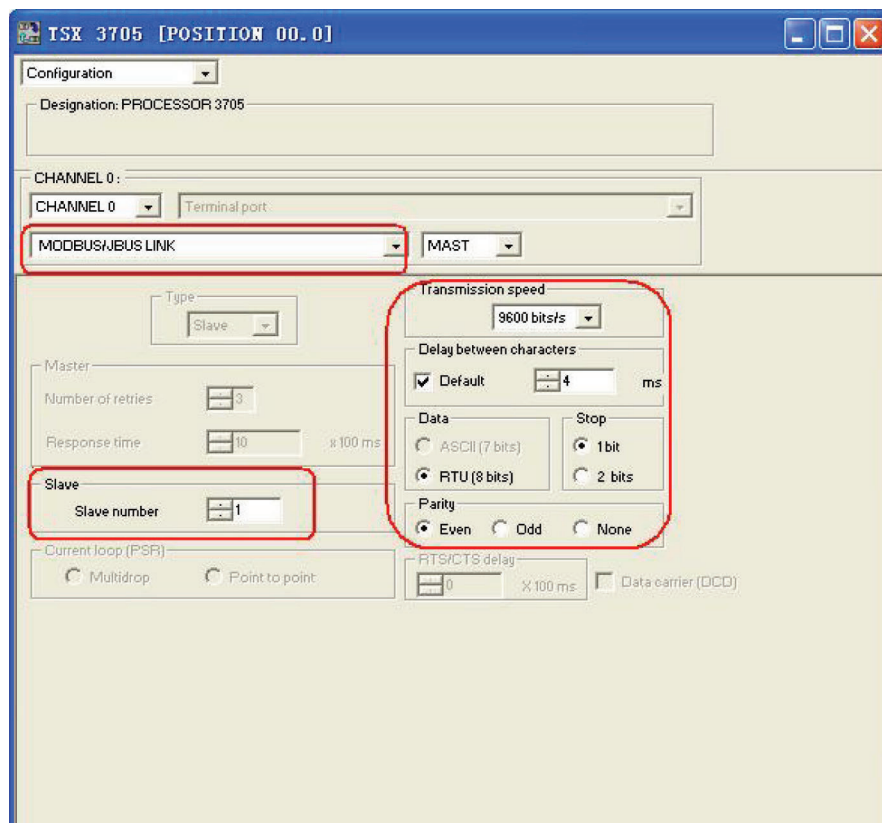

**6** Download the project to PLC after the settings are completed.

## PT Settings

- **When Using Schneider Twido Modbus RTU Protocol**

PT default communication parameters: 19200bps (Baud Rate), 8 (Data Bit), none (Parity Check), 1 (Stop Bit) and 1 (PLC Station No.)

RS485 Communication

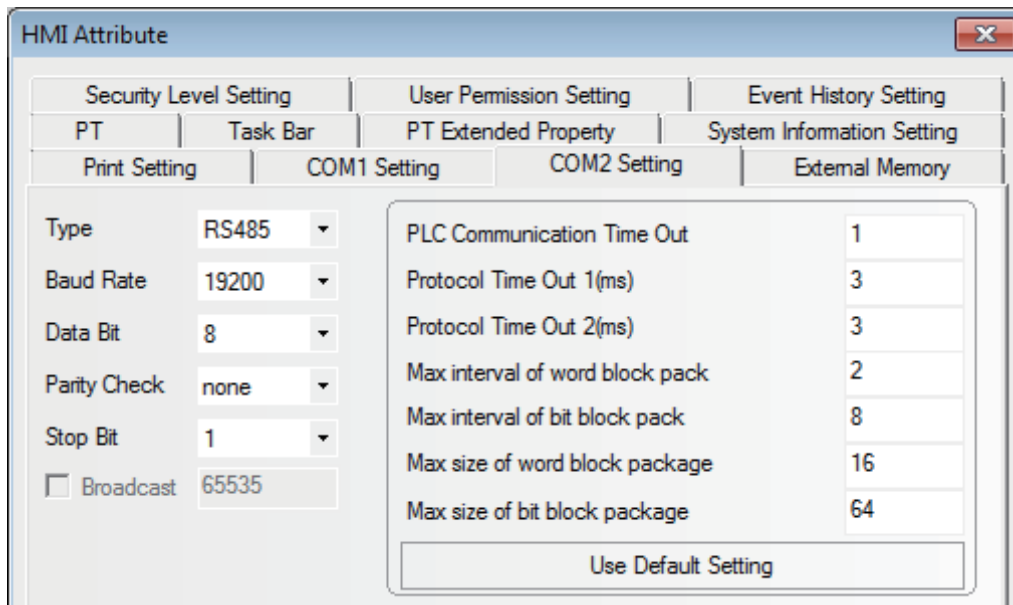

RS232 Communication

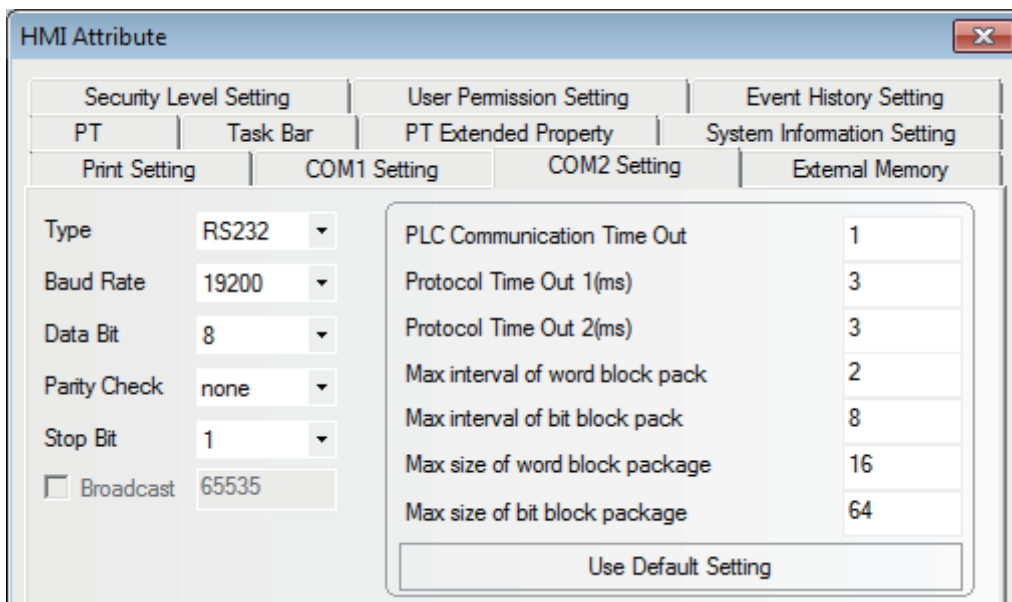

## PLC Settings

### ● When Using Schneider Twido Modbus RTU Protocol

**Note** The memory addresses of Twido are under dynamic management, which may lead to communication failure when address link is available. Refer to the setting method of PLC as follows and set the words or bits correctly. It is recommended the user to add a line of ladder program in the following item of 3 to the end of the ladder program created by the user.

If the settings are mistaken, the PLC cannot communicate with the PT device.

#### 1 Controller Communications Setup

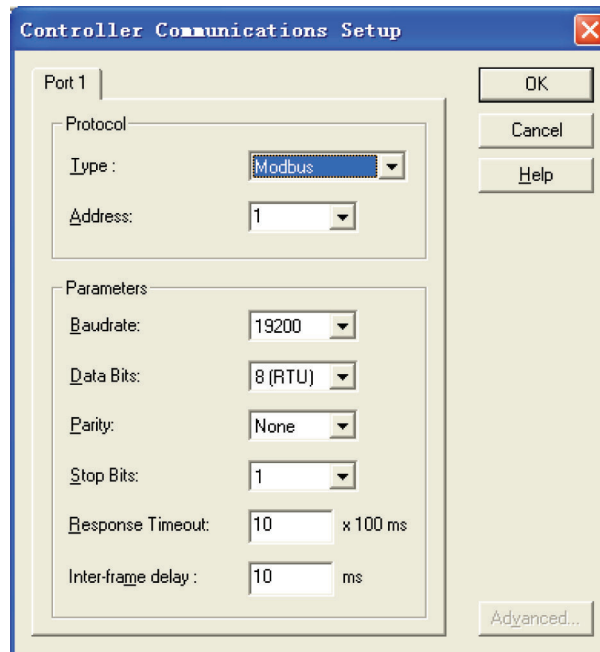

- 2** Expand the range of word memory address. Then change the [Auto] option in the [Assigned] column after selecting [Controller], [Used Memory] and [Edit] to a larger variable than internal memory and download the settings to the PLC.  
 It is assumed that the “Auto” is set to 3000 as shown below, all addresses before %MW3000 can perform the data swap.

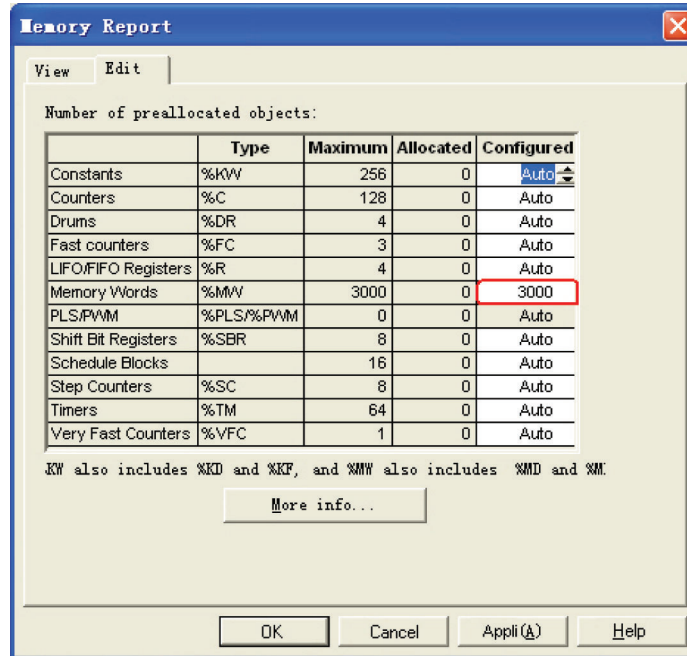

- 3** Extend the range of open bit address and drive the coil with a maximum address through the programming.  
 It is assumed that a %M127 coil is driven as shown below, all addresses before %M127 can perform the data swap.

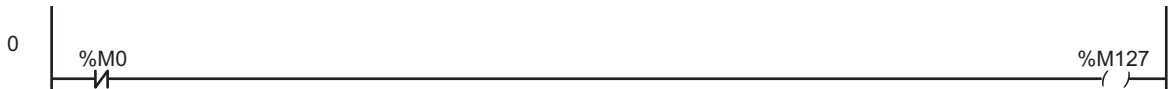

## 4-4 Supported Registers

### Modicon TSX

Device	Bit Address	Word Address	Format	Notes
System Internal Nodes	S00000-32767	-----	DDDDD	
Internal Auxiliary Nodes	M00000-32767	-----	DDDDD	
Data Register Bit Nodes	MW.B0000-9999.F	-----	DDDD.H	
Data Registers	-----	MW0000-7999	DDDD	
Data Registers (32-bit)	-----	MD0000-7999	DDDD	

### Twido

Device	Bit Address	Word Address	Format	Notes
Internal Auxiliary Nodes	0X 1-9999	-----	DDDD	
	1X 1-9999	-----	DDDD	
	-----	3X 1-9999	DDDD	
Data Registers	-----	4X 1-9999	DDDD	

**Note** The registers M and MW in TWIDO software correspond to 0X and 4X of PT respectively. The address offset of PT and PLC is 1.

Do not use 1X and 3X of PT for there are no registers in TWIDO software corresponding to them.

The PT address must be "PLC address + 1". For example: The M0 in PLC corresponds to 0X1 of PT.

Address format description: D: decimal, O: octonary, H: hexadecimal.

## 4-5 Cable Fabrication

### When Using Schneider Modicon Uni-TelWay Protocol

#### ● RS232 Communication Cable

Use serial port programming cable manufactured by Schneider directly to communicate with PT.

**Note** Direct the middle cable knob to position 2 and add a RS232 cable directly between the PT and programming cable.

#### ● RS485 Communication Cable

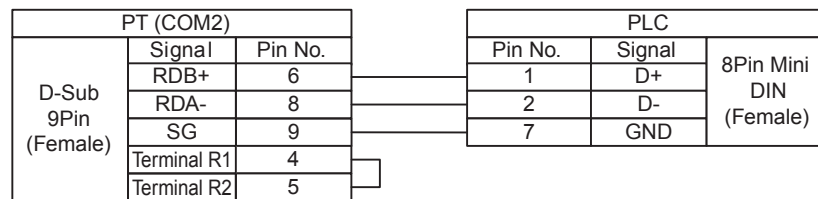

### When Using Modbus RTU Protocol

#### ● RS232 Communication Cable

Use serial port programming cable manufactured by Schneider directly to communicate with PT.

**Note** Direct the middle cable knob to position 3

#### ● RS485 Communication Cable

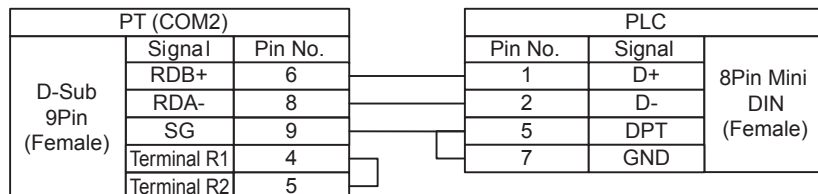

### When Using Schneider Twido Modbus RTU Protocol

#### ● RS232 Communication Cable

Use serial port communication cable manufactured by Schneider directly to communicate with PT.

#### ● RS485 Communication Cable

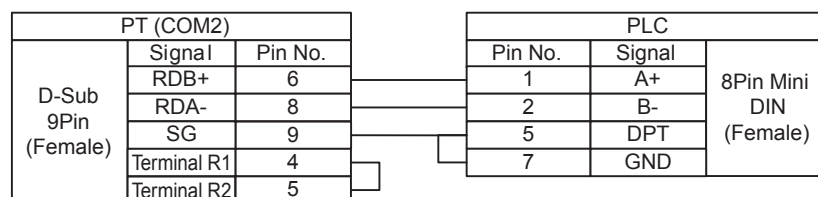



# 5

## Modbus Connection

This section describes the connection on Modbus protocol.

NB□□-TW□□B and NB□□-TW□□B-V1 support different PLC models, please refer to *Section 1* for details.

---

<b>5-1</b>	<b>Serial Port and Ethernet</b>	<b>5-2</b>
<b>5-2</b>	<b>Communication Parameters and Cable Fabrication</b>	<b>5-3</b>
<b>5-3</b>	<b>Communication Parameter Setting</b>	<b>5-4</b>
<b>5-4</b>	<b>Supported Registers</b>	<b>5-7</b>
<b>5-5</b>	<b>Cable Fabrication</b>	<b>5-9</b>
<b>5-6</b>	<b>Modbus Protocol</b>	<b>5-10</b>
5-6-1	Introduction to Modbus Protocol	5-10
5-6-2	When NB adopts Modbus TCP protocol (Master/Slave mode)	5-11
<b>5-7</b>	<b>Example of NB as Modbus Slave</b>	<b>5-12</b>
<b>5-8</b>	<b>Example of connection using Modbus TCP protocol</b>	<b>5-15</b>
<b>5-9</b>	<b>Example of E5CC/E5EC, 3G3MX2 connection using Modbus RTU Extend Protocol</b>	<b>5-16</b>
<b>5-10</b>	<b>Example of Power PMAC Motion Controller using Modbus TCP Slave Protocol</b>	<b>5-18</b>

## 5-1 Serial Port and Ethernet

Series	CPU	Link Module	SIO Type	Driver
Modbus RTU	Modbus Compatible External Device	RS232 on the CPU unit	-	Modbus RTU
		RS422 on the CPU unit	-	Modbus RTU
		RS485 on the CPU unit	-	Modicon_BE
Modbus RTU Extend		RS232 on the CPU unit	-	Modbus RTU Extend
		RS422 on the CPU unit	-	
		RS485 on the CPU unit	-	
Modbus RTU Slave		RS232 on the CPU unit	-	Modbus RTU Slave
		RS422 on the CPU unit	-	
		RS485 on the CPU unit	-	
Modbus ASCII		RS232 on the CPU unit	-	Modbus ASCII
	RS422 on the CPU unit	-		
	RS485 on the CPU unit	-		
Modbus TCP		-	Ethernet	Modbus TCP
Modbus TCP Slave		-	Ethernet	Modbus TCP Slave
Modbus RTU Extend	Thermoregulator (Digital Regulator) E5CC/E5EC (RS485 Connection)	RS485	-	Modbus RTU Extend
Modbus RTU Extend	Multi-function Compact Inverter 3G3MX2 *1	RS485	-	Modbus RTU Extend
Modbus TCP Slave	Power PMAC Etherlite	-	Ethernet	Modbus TCP Slave

\*1 Connectable 3G3MX2 Series models are 3G3MX2-V1 or higher that support Endian data conversion. Other models cannot handle 2-word data properly.

## 5-2 Communication Parameters and Cable Fabrication

Series	CPU	Link Module	COMM Type	Parameter	Cable
Modbus RTU	Modbus Compatible External Device	RS232 on the CPU unit	RS232	Refer to Section 5-3	Self-made cable required
		RS422 on the CPU unit	RS422		
		RS485 on the CPU unit	RS485		
Modbus RTU Extend		RS232 on the CPU unit	RS232		
		RS422 on the CPU unit	RS422		
		RS485 on the CPU unit	RS485		
Modbus RTU Slave		RS232 on the CPU unit	RS232		
		RS422 on the CPU unit	RS422		
		RS485 on the CPU unit	RS485		
Modbus ASCII	RS232 on the CPU unit	RS232			
	RS422 on the CPU unit	RS422			
	RS485 on the CPU unit	RS485			
Modbus TCP		-	Ethernet		Network cable
Modbus TCP Slave		-	Ethernet		Network cable
Modbus RTU Extend	Thermoregulator (Digital Regulator) E5CC/E5EC (RS485 Connection)	RS485	RS485		Self-made cable required
Modbus RTU Extend	Multi-function Compact Inverter 3G3MX2	RS485	RS485		Self-made cable required
Modbus TCP Slave	Power PMAC Etherlite	-	Ethernet		Network cable

## 5-3 Communication Parameter Setting

### PT Settings

- **When Using Modbus RTU Protocol**

PT default communication parameters: 9600bps (Baud Rate), 8 (Data Bit), even (Parity Check), 1 (Stop Bit) and 1 (PLC Station No.)

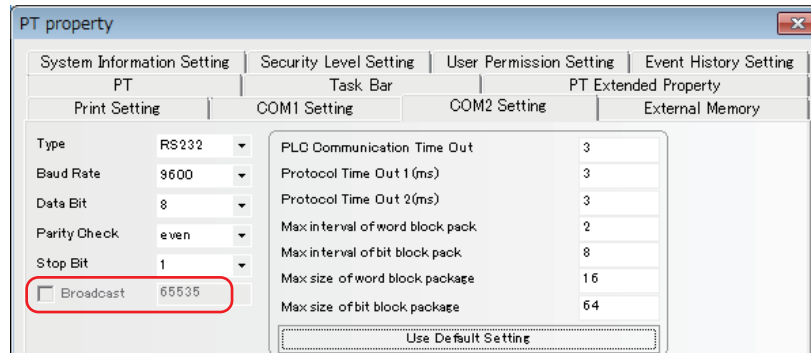

**Note** Modbus RTU driver supports little-endian and Modbus RTU Modicon\_BE supports big-endian. NB's Modbus communication does not support broadcasting.

- **When Using Modbus RTU Extend Protocol**

PT default communication parameters: 9600bps (Baud Rate), 8 (Data Bit), even (Parity Check), 1 (Stop Bit) and 1 (PLC Station No.)

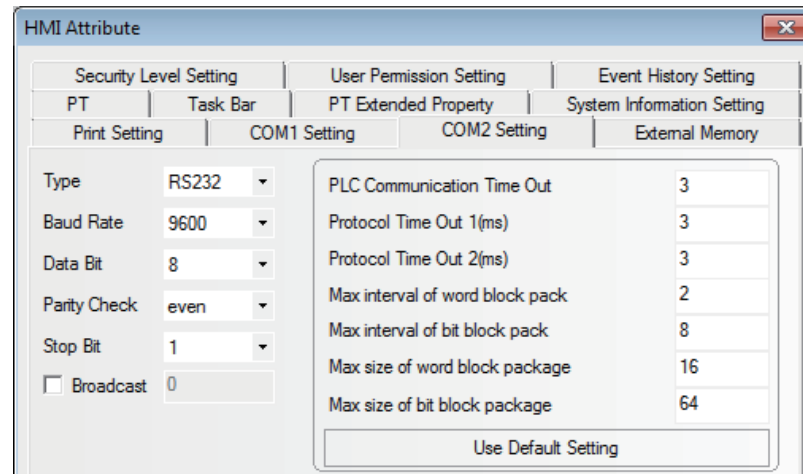

### ● When Using Modbus RTU Slave Protocol

PT default communication parameters: 9600bps (Baud Rate), 8 (Data Bit), even (Parity Check), 1 (Stop Bit) and 1 (PLC Station No.)

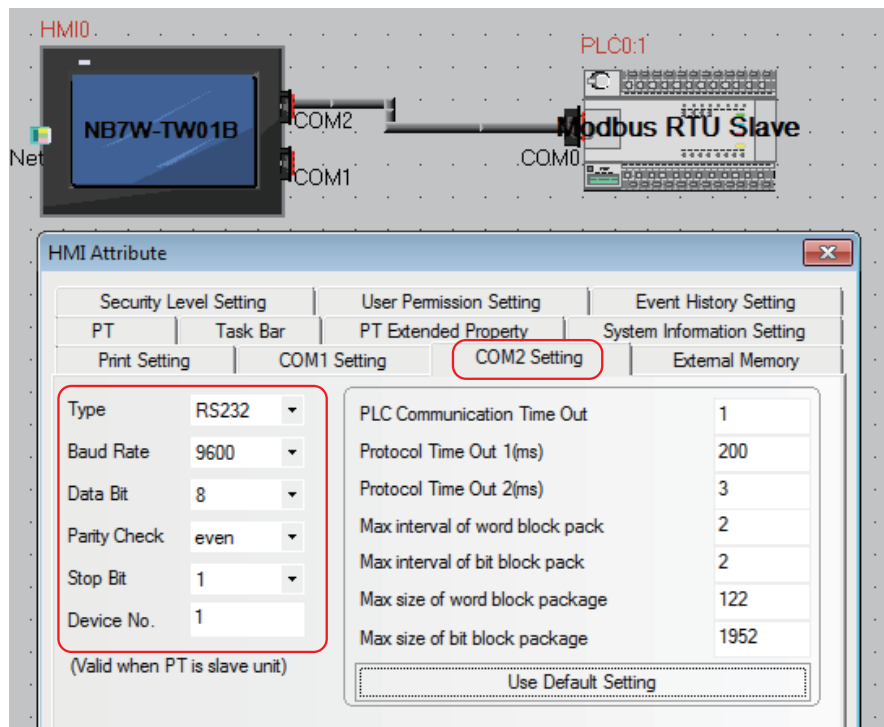

### ● When Using Modbus ASCII Protocol

PT default communication parameters: 9600bps (Baud Rate), 8 (Data Bit), even (Parity Check), 1 (Stop Bit) and 1 (PLC Station No.)

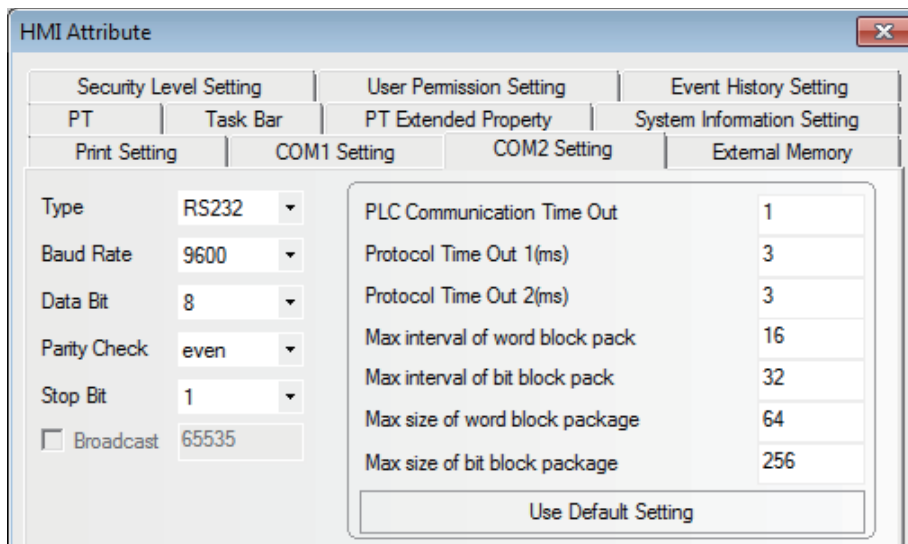

● **For communication using Modbus TCP (when PT is master)**

PT serves as the master and PLC serves as the slave.

Since the PT sends a request to the PLC, setting the PLC to be communicated with is required on the PT. The network configuration is as follows.

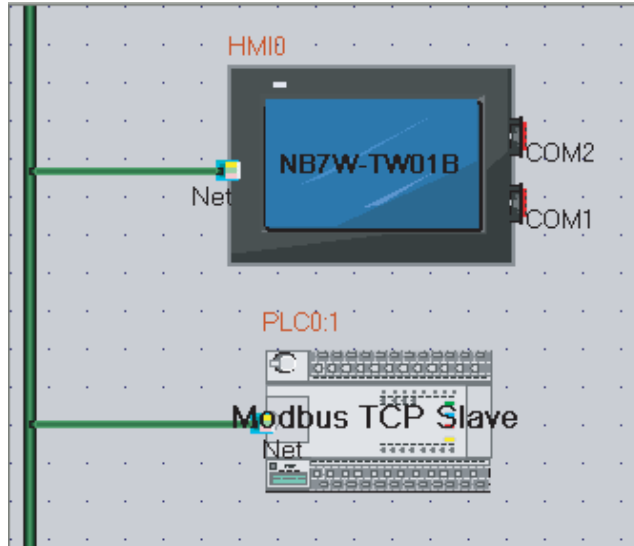

Network Config

Device	IP Addr	Port	Protocol	Master/Slave	State NO.	Virtual...
HMI0	192.168.250.1	502	Modbus TCP	M		
PLC0	192.168.250.2	502	Modbus TCP Slave	S	1	

● **For communication using Modbus TCP (when PT is slave)**

PT serves as the slave and PLC serves as the master.

Since the PT waits for a request from any PLC, a PLC setting on the PT is not required. The network configuration is as follows.

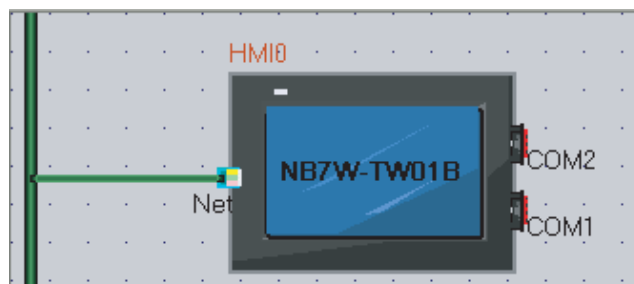

Network Config

Device	IP Addr	Port	Protocol	Master/...	State...	Virtual...
HMI0	192.168.250.1	502	Modbus TCP Slave	S	1	10000

Refer to 5-7 Example of NB as Modbus Slave for example.

## 5-4 Supported Registers

### Modbus RTU

Device	Bit Address	Word Address	Format	Notes
System Internal/External Output Nodes	0X 1-65535	-----	DDDDD	
System Internal/External Input Nodes	1X 1-65535	-----	DDDDD	
Analog Input Data Registers	-----	3X 1-65535	DDDDD	
Data Registers	-----	4X 1-65535	DDDDD	

### Modbus RTU Modicon\_BE

Device	Bit Address	Word Address	Format	Notes
System Internal/External Output Nodes	0X 1-65535	-----	DDDDD	
System Internal/External Input Nodes	1X 1-65535	-----	DDDDD	
Analog Input Data Registers	-----	3X 1-65535	DDDDD	
Data Registers	-----	4X 1-65535	DDDDD	
Data Registers	-----	5X 1-65535	DDDDD	
Data Registers	-----	4X-DINV 1-65535	DDDDD	32 bit device
Data Registers	-----	5X-DINV 1-65535	DDDDD	32 bit device

**Note 1** The value which endian of 4x is reversed by the unit of Word is set to 5x.

Example: When 0x1234 is stored to 4X, 0x3412 is set to 5X.

**2** The values which endian of 4X and 5X is reversed by the unit of Double Word are set to 4X-DINV and 5X-DINV, respectively.

Example: When 0x12345678 is stored to 4X, 0x56781234 is set to 4X-DINV.

### Modbus RTU Extend

Device	Bit Address	Word Address	Format	Notes
System Internal/External Output Nodes	0X 1-65535	-----	DDDDD	
System Internal/External Input Nodes	1X 1-65535	-----	DDDDD	
Analog Input Data Nodes	3X_bit 1.00-65535.15	-----	DDDDD.DD	
Data Nodes	4X_bit 1.00-65536.15	-----	DDDDD.DD	
4X Single Write Data Nodes	6X_bit 1.00-65535.15	-----	DDDDD.DD	
Analog Input Data Registers	-----	3X 1-65535	DDDDD	
Data Registers	-----	4X 1-65536	DDDDD	
Data Registers	-----	5X 1-65535	DDDDD	
4X Single Write	-----	6X 1-65535	DDDDD	
Data Registers	-----	3X-DINV 1-65535	DDDDD	32 bit device
Data Registers	-----	4X-DINV 1-65535	DDDDD	32 bit device

**Note 1** The value which endian of 4X is reversed by the unit of Word is set to 5X.

Example: When 0x1234 is stored to 4X, 0x3412 is set to 5X.

**2** The values which endian of 3X and 4X is reversed by the unit of Double Word are set to 3X-DINV and 4X-DINV, respectively.

Example: When 0x12345678 is stored to 3X, 0x56781234 is set to 3X-DINV.

**3** When connecting to E5CC/E5EC, use 4X for the address since all addresses are handled as holding register.

## Modbus RTU Slave

Device	Bit Address	Word Address	Format	Notes
System Internal/External Output Nodes	LB 0-8999	-----	DDDDD	Mapping to 0x 1~9000
Data Registers	-----	LW 0-8999	DDDDD	Mapping to 4x 1~9000

## Modbus ASCII

Device	Bit Address	Word Address	Format	Notes
System Internal/External Output Nodes	0X 1-65535	-----	DDDDD	
System Internal/External Input Nodes	1X 1-65535	-----	DDDDD	
Analog Input Data Registers	-----	3X 1-65535	DDDDD	
Data Registers	-----	4X 1-65535	DDDDD	

## Modbus TCP Slave

Device	Bit Address	Word Address	Format	Notes
System Internal/External Output Nodes	0X 1-65535	-----	DDDDD	
System Internal/External Input Nodes	1X1-65535	-----	DDDDD	
Analog Input Data Nodes	3X_bit 1.00-65535.15	-----	DDDDD.DD	
Data Nodes	4X_bit 1.00-65535.15	-----	DDDDD.DD	
Analog Input Data Registers	-----	3X1-65535	DDDDD	
Data Registers	-----	4X1-65535	DDDDD	
Data Registers	-----	4X-DINV 1-65535	DDDDD	
Data Registers	-----	3X-DINV 1-65535	DDDDD	

**Note** Address format description: D: decimal, O: octonary, H: hexadecimal.



## 5-5 Cable Fabrication

### ● RS232 Communication Cable

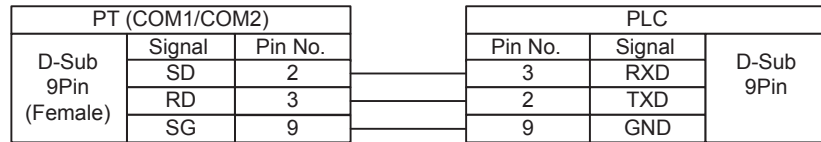

### ● RS422 Communication Cable

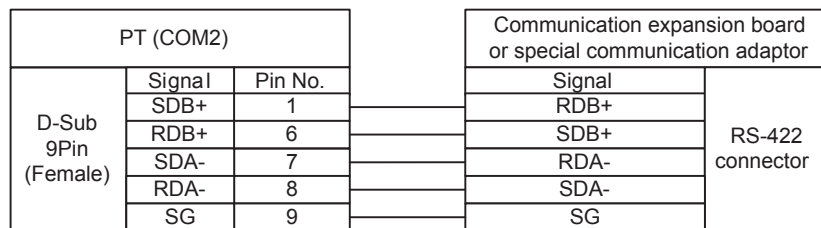

### ● RS485 Communication Cable (PLC)

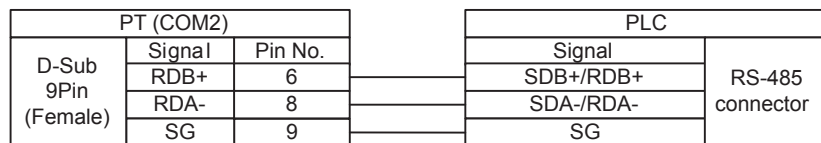

### ● RS485 Communication Cable (E5CC/E5EC)

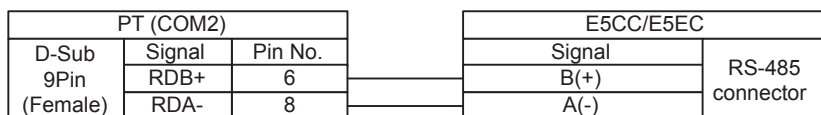

### ● RS485 Communication Cable (3G3MX2)

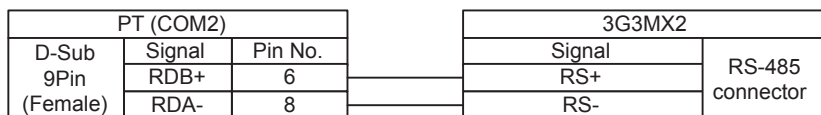

#### Precautions for Correct Use

For RS422/485, a terminating resistance short circuit is required. A short-circuit may depend on an NB model. Thus, please refer to *1-2 Part Specifications* in the *NB-series Programmable Terminals Setup Manual* (Cat. No. V107).

### ● Ethernet Communication Cable

Use Twisted Pair Cable to connect. Refer to *Ethernet communication specifications* in *A-1-3 Communication Specifications* in the *NB-series Programmable Terminals Setup Manual* (Cat. No. V107).

## 5-6 Modbus Protocol

### 5-6-1 Introduction to Modbus Protocol

Modbus functions as a request-response protocol which provides the service specified by function codes.

Modbus protocol such as ASCII, RTU, and TCP does not specify the physical layer, but defines the message frame and is available to communicate with the Controllers through varied networks. In ASCII mode and RTU mode, the protocol is composed of the each combination of message and data, or command and response. The data communications of Modbus adopt master-slave mode. In the mode, first of all, the master sends a message and the slave receives the message, followed by the slave replies the data to the request by the master.

As the master can also send the data directly to the slave to change the data of the slave, that means the master and the slave can perform bidirectional read and write.

When the PTs of NB series performs the communications following the Modbus protocol, it is performed in accordance with Modbus communications procedure.

Common format of message frame is shown as follows.

Address code	Function code	Data area	Error checking code
8 bits	8 bits	N × 8 bits	16 bits

#### ● Address code

Data field of the message frame is two characters when the transmission mode is ASCII and eight bits when it is RTU. Addresses of the slave are ranged from 0 to 247 (written by decimal) and addresses of each device are allocated from 1 to 247. The master device select the slave device through the data field of the message in which the addresses of the slave communicating with the master are stored. When the slave replies the message, in order to recognize which slave replied to the message, the addresses replied from the slave are stored in the data field of the response message. Address 0 is used as a broadcast address which can be recognized by all the slave devices.

#### ● Function code

Modbus Function Code	Name	Function	Corresponding Address Type
01	Read coil status	Reads the bit data (N bits)	0x
02	Read input discrete value	Reads the bit data	1x
03	Read multiple registers	Reads the integer type/character type/status word /floating-point data (N words)	4x
04	Read input registers	Reads the integer type/status word/ floating-point type data	3x
05	Write single coil	Writes the bit data (one bit)	0x
06	Write single register	Writes the integer type/character type/status word /floating-point data (one word)	4x
15	Write multiple coils	Writes the bit data (N bits)	0x
16	Write multiple registers	Writes the integer type/character type/status word /floating-point data (N words)	4x

The read/write function codes corresponding to each mode are as follows:

Function \ Mode	Modbus RTU, Modbus RTU Extend, Modbus RTU Slave, Modbus ASCII		Modbus TCP	
	Bit	Word	Bit	Word
Read	01, 02	03, 04	01, 02*	03, 04*
Write	05, 15	06, 16	05, 15	06, 16

\* This function code is not supported when the PT operates as the slave.

### ● Data area

The data area includes the required data from PT or replied data from the devices such as variables, referred addresses, and setting values. For instance, when the PT is informed of memory read by the function code, which memory and which area of the memory should be read are necessary to be specified in the data field. The specified addresses and data type are varied according to the slave specifications.

### ● Error checking code

Modbus protocol checks if the message frame could be received correctly. Besides the parity check of serial protocol, it is checked using LRC in ASCII mode or 16 bits CRC in RTU mode. In TCP mode, only parity check is performed.

## 5-6-2 When NB adopts Modbus TCP protocol (Master/Slave mode)

When the PLC and the PT are connected via the Modbus protocol, 2 situations exist depending on the master and slave statuses of the devices.

Method	Mater/Slave	Protocol used	Descriptions
1	PT as the master	Modbus TCP	The PT accesses the 0X, 1X, 3X and 4X registers mapped out by the PLC.
	PLC as the slave	Modbus TCP Slave	
2	PT as the slave	Modbus TCP Slave	The PT local address LW is mapped as the 4X register, and the LB as the 0X register.
	PLC as the master	Modbus TCP	

(1) PT is the master and PLC is the slave

The PT as the master and the PLC as the slave communicate through the Modbus TCP protocol. The PLC is operated in slave mode of Modbus TCP protocol, and also performs mapping on the 0X, 1X, 3X and 4X registers (hereof, the 0X and 1X are bit registers, and the 3X, while 3X and 4X are word registers.)

(2) PLC is the master, and PT is the slave

The PLC as the master and the PT as the slave communicate through the Modbus TCP protocol. The PLC is operated as the master in the Modbus TCP protocol. The PT performs mapping LB on the 0X and LW on the 4X registers. These addresses can be written and read by the PLC.

The corresponding relations of the registers are as below:

Modbus register address range	The corresponding PT local address range
0X(1---9000)	LB(0---8999)
4X(1---9000)	LW(0---8999)

## 5-7 Example of NB as Modbus Slave

Communication by Modbus RTU Slave protocol

System description: Use CP1E-N30D□-□ (30-point I/O type) as Modbus master and an NB Unit as Modbus slave to perform the communication.

### PLC Setting

CP1E-N30D□-□ should connect to CP1W-CIF11 module functioning as RS485 communication port.

Use CX-Programmer to configure the peripheral port.

Make the communication settings as follows: 9600, 8, 1, Even and Modbus-RTU simple master.

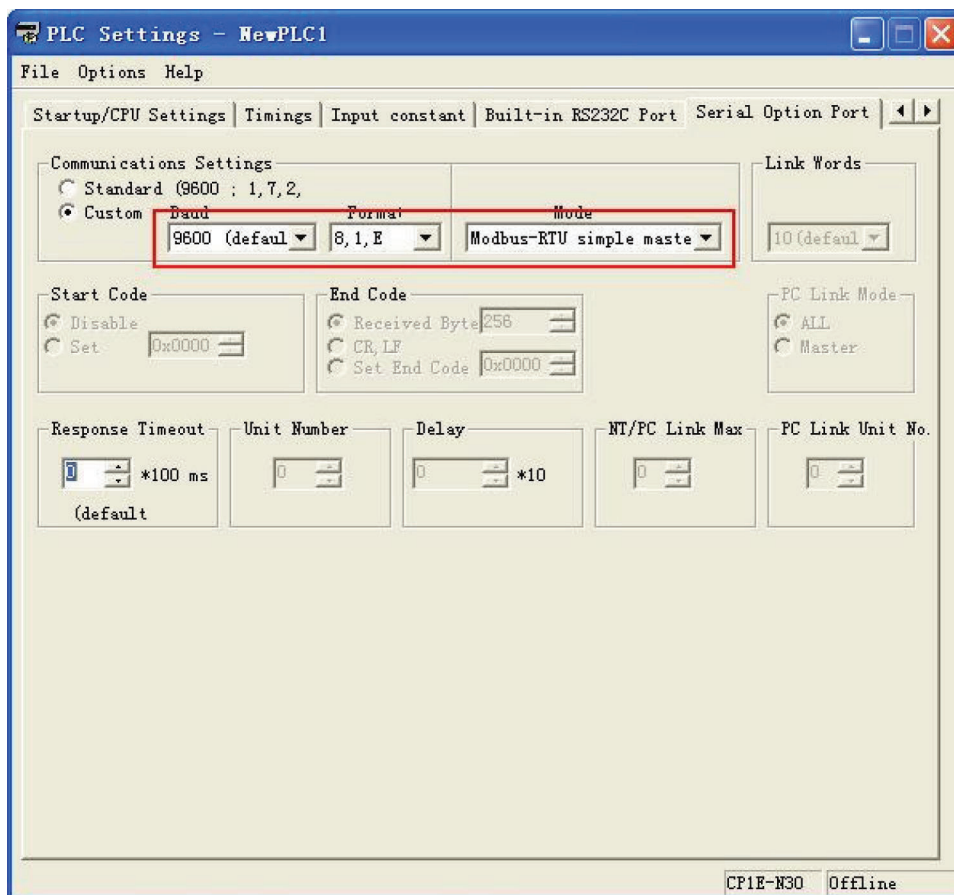

## NB Unit Setting

We take one NB7W-TW00B as example with the system configuration as shown below:

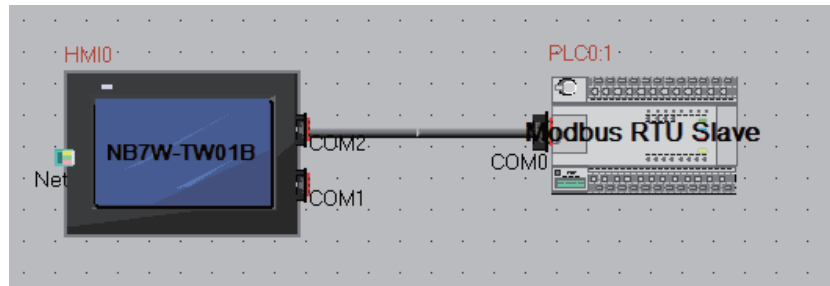

NB7W-TW00B communication settings: 9600 (Baud Rate), 8 (Data Bit), 1 (Stop Bit), Even (Parity Check) and 1 (device No.), as shown below:

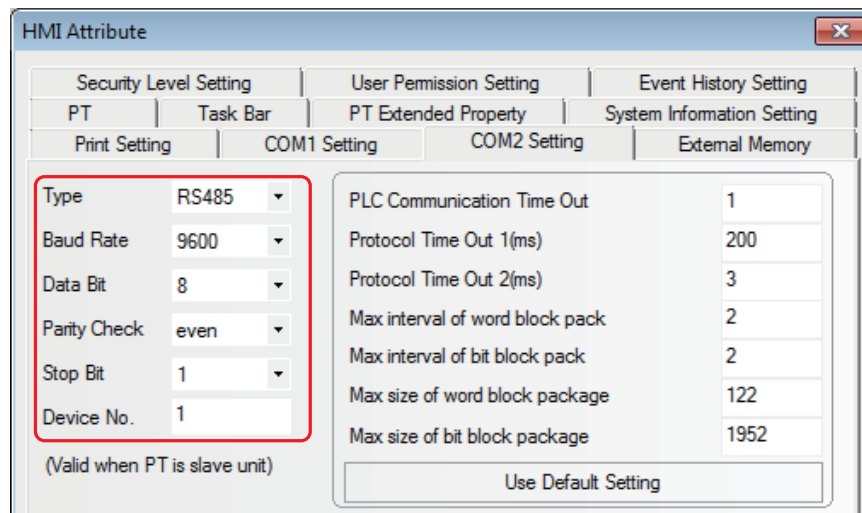

## Cable Fabrication

NB7W-TW00B  
COM2(female)

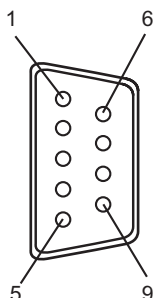

Signal	Pin No.
SDB+	1
SD(TXD)	2
RD(RXD )	3
Terminal 1	4
Terminal 2	5
RDB+	6
SDA-	7
RDA-	8
SG	9
FG	Connector shell

OMRON PLC side CP1W-CIF11

Pin No.	Signal
1	RDA-
2	RDB+
3	SDA-
4	SDB+
5	FG

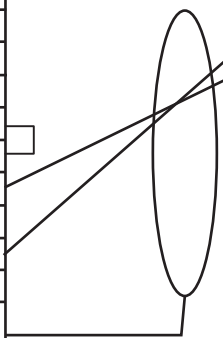

## 5-8 Example of connection using Modbus TCP protocol

Use Modbus TCP protocol to perform the communication, PT serving as the slave.

### PLC Setting

Since Modbus TCP is a general purpose protocol, setting method differs depending on the PLC. Please confirm the setting of PLC used before making the settings.

PLC produced by Schneider is used in this section as an example.

Make the settings for Schneider PLC which supports Modbus TCP protocol as follows.

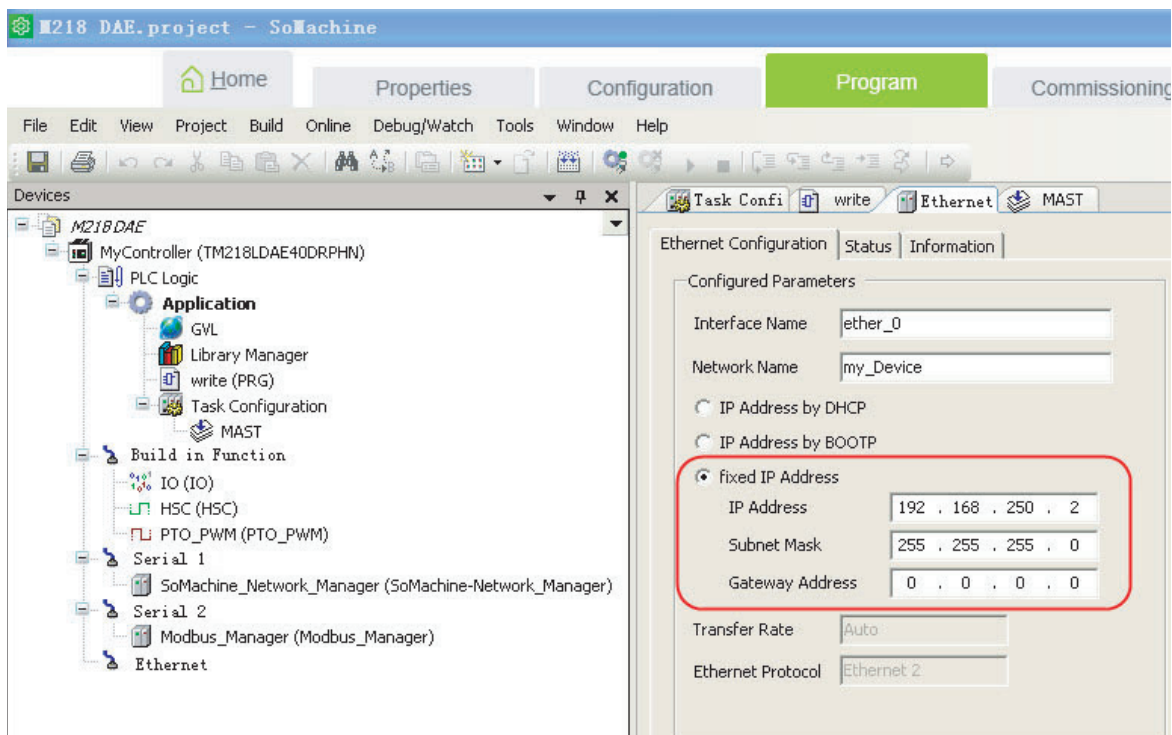

### PT Setting

Device	IP Addr	Port	Protocol	Master/...	State...	Virtual...
HMI0	192.168.250.1	502	Modbus TCP Slave	S	1	10000

For the details on network configuration, refer to “When Using Modbus TCP Protocol” in 5-3 *Communication Parameter Setting*.

## 5-9 Example of E5CC/E5EC, 3G3MX2 connection using Modbus RTU Extend Protocol

### Unit Setting

Connect with the NB using RS485 communication port.

Set or check Baud Rate, Data Bit, Parity Check and Stop Bit using the operator came with the unit.

Make sure the communication setting of NB unit and the temperature controller or the inverter corresponds.

### NB Communication Setting

We take NB7W-TW01B as example with the configuration and setting as shown below:

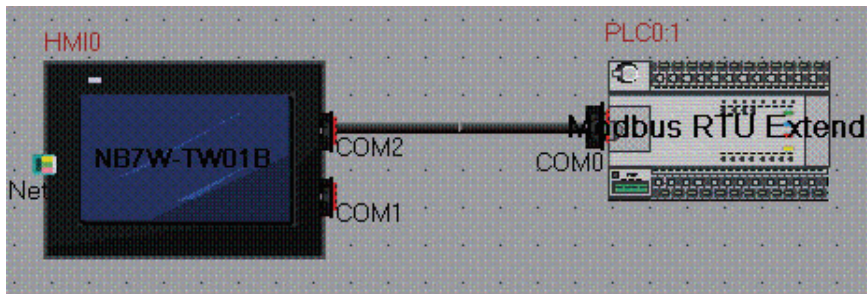

An example of COM2 setting in PT communication setting is shown below: 9600 (Baud Rate), 8 (Data Bit), 1 (Stop Bit), Even (Parity Check)

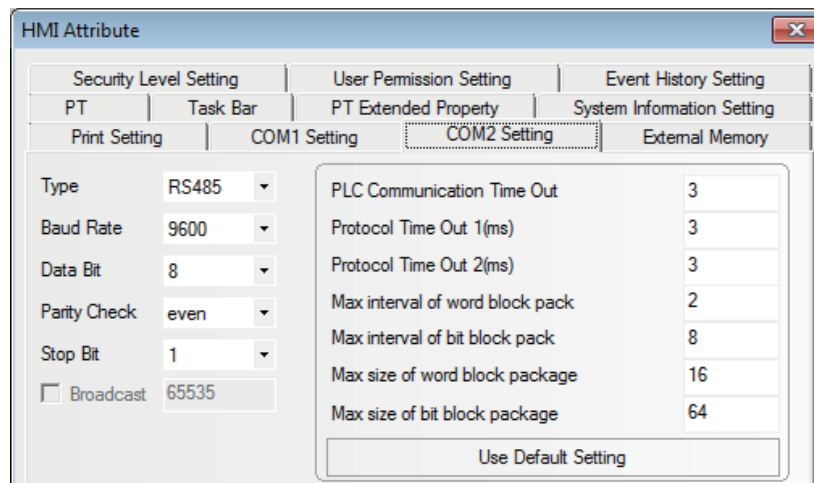

### Precautions for Correct Use

Proper setting for Max interval of word block pack and so on depends on the connected device. Make sure to refer to the manuals of the connected device for proper setting.



## Cable Fabrication

NB7W-TW01B  
COM2(female)

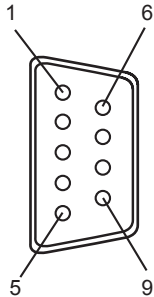

Signal	Pin No.
SDB+	1
SD(TXD)	2
RD(RXD)	3
Terminal 1	4
Terminal 2	5
RDB+	6
SDA-	7
RDA-	8
SG	9
FG	Connector shell

E5CC/E5EC

Signal	RS-485 connector
A(-)	
B(+)	
SG	

NB7W-TW01B  
COM2(female)

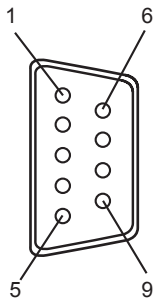

Signal	Pin No.
SDB+	1
SD(TXD)	2
RD(RXD)	3
Terminal 1	4
Terminal 2	5
RDB+	6
SDA-	7
RDA-	8
SG	9
FG	Connector shell

3G3MX2

Signal	RS-485 connector
RS-	
RS+	
SG	



### Precautions for Correct Use

- An address is written in hexadecimal in *E5□□ Digital Temperature Controllers COMMUNICATION MANUAL* (Cat. No. H175) or *SYSDRIVE MX2 Series Multi-function Compact Inverter USER'S MANUAL* (Cat. No. I570) but needs to be input in decimal in NB-Designer.
- Also, the top address starts with 0 in *E5□□ Digital Temperature Controllers COMMUNICATION MANUAL* (Cat. No. H175) or *SYSDRIVE MX2 Series Multi-function Compact Inverter USER'S MANUAL* (Cat. No. I570) but needs to be changed by converting it from hexadecimal to decimal and adding one for input in NB-Designer. An address has to start with 1 in NB-Designer.
- When connecting to E5CC/E5EC, 2 byte mode address appoint method should be used. Moreover, Use the addresses 2406 - 2407 for the status address with data length of 32 bit. Data cannot be handled properly when the address 2001 is used.
- 3G3MX2 cannot access parameters with double word.
- 3G3MX2-V1 can access only low-order word of parameters with double word by using Modbus mapping function. For details, please refer to *SYSDRIVE MX2 Series Multi-function Compact Inverter USER'S MANUAL* (Cat. No. I570).
- When connecting to E5CC/E5EC or 3G3MX2, more than 1 of Unit No. should be used.

## 5-10 Example of Power PMAC Motion Controller using Modbus TCP Slave Protocol

The NB communicates with the Power PMAC using the Ethernet communication port via the Modbus TCP Slave protocol with the PT designated as a master unit. Therefore, the communication settings between the NB and the Power PMAC must be consistent. This section describes an example of the settings.

### ● System Configuration

Following is an example of configuration and settings when Model NB7W-TW01B is used:

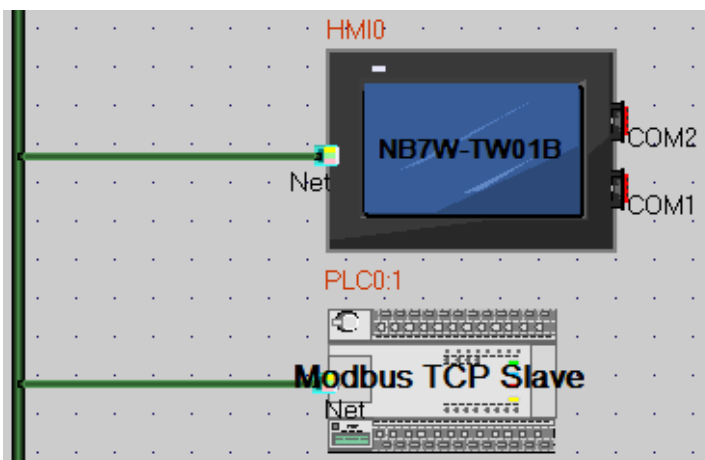

### ● PT Settings

Device	IP address	Port No.	Protocol	Master/Slave	Station number	Virtual PLC number
HMI0	192.168.250.1	502	Modbus TCP	M		
PLC0	192.168.250.2	502	Modbus TCP Slave	S	1	

Perform the NB communication settings as described below:

## ● Power PMAC Settings



Device	IP address	Port No.	Protocol	Master/Slave	Station number	Virtual PLC number
HMI0	192.168.250.1	502	Modbus TCP	M		
PLC0	192.168.250.2	502	Modbus TCP Slave	S	1	

Perform the Power PMAC settings as described below:

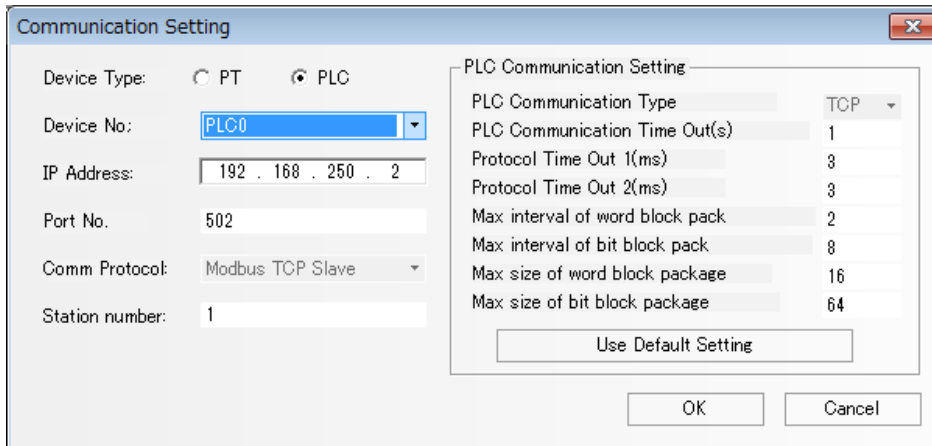

Communication Setting

Device Type:  PT  PLC

Device No:

IP Address:

Port No.:

Comm Protocol:

Station number:

PLC Communication Setting

PLC Communication Type:

PLC Communication Time Out(s):

Protocol Time Out 1(ms):

Protocol Time Out 2(ms):

Max interval of word block pack:

Max interval of bit block pack:

Max size of word block package:

Max size of bit block package:

In addition, add the following item to the "global definitions.pmh" file on the Power PMAC IDE tool to make the Power PMAC operate as the Modbus TCP slave unit.

```
Sys.ModbusServerEnable = 1
```

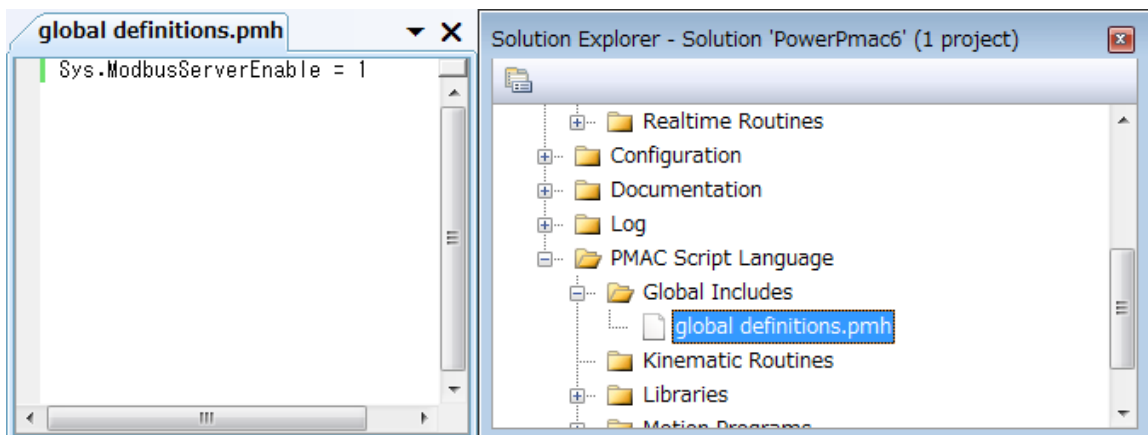

## ● Address Mapping

The data on the Power PMAC are managed as variables. By enabling the Modbus TCP slave function on the Power PMAC side, the Modbus addresses are automatically linked with those of the variables on the Power PMAC. The following table shows the address correspondence between PMAC and Modbus.

PMAC variables	Address range	Modbus addresses	Address range
I variable	I0-6143	4X-DINV	4098-16384
M variable	M0-8191	4X-DINV	16386-32768
P variable	P0-8191	4X-DINV	32770-49152
Q variable	&O Q0-1023	4X-DINV	49154-51200

Note that all the Power PMAC variables are handled in the 32-bit floating-point representation, and that NB therefore must read/write data in units of 32 bits. Beware that the functions that cannot handle the 32-bit floating-point format are not available.

In addition, the Power PMAC, by default, sends data with the 16 high bits and the 16 low bits switched. Thus, for the Modbus address, you must use the DINV area.



### **Precautions for Correct Use**

To make communication efficient, the NB exchanges as a batch the data of the length according to the values specified in "Max size of word block package". For example, when addresses 4X-DINV 00001, 4X-DINV 00008, and 4X-DINV 00016 exist on the screen while this is set to 16, the NB obtains 4X-DINV 00001 through 4X-DINV 00016 as a batch.

However, the Power PMAC does not support communication of the data that extend across different variables. Therefore, be careful of the following points.

When assigning multiple variables on a single screen, make sure that the range specified by "Max size of word block package" does not include more than one address.

Example of correct settings:

Address set for Object 1: I6143(4X-DINV 16384)

Address set for Object 2: M200(4X-DINV 16786)

Example of erroneous settings:

Address set for Object 1: I6143(4X-DINV 16384)

Address set for Object 2: M2(4X-DINV 16390)

To freely set addresses, set "Max size of word block package" to "2". Note, however, that when you perform the above setting, the amount of communication becomes large, which will affect performance. Confirm the performance before moving on to actual operations.

# 6

## Connecting to Delta PLCs

This section describes the connection to Delta PLCs

---

<b>6-1</b>	<b>Serial Port Communication</b>	<b>6-2</b>
<b>6-2</b>	<b>Communication Parameters and Cable Fabrication</b>	<b>6-3</b>
<b>6-3</b>	<b>Communication Parameter Setting</b>	<b>6-4</b>
<b>6-4</b>	<b>Supported Registers</b>	<b>6-6</b>
<b>6-5</b>	<b>Cable Fabrication</b>	<b>6-7</b>

## 6-1 Serial Port Communication

---

Series	CPU	Link Module	Driver
DVP	DVP-XXES/EX/SS DVP-XXSA/SX/SC DVP-XXEH/EH2/SV	RS232 on the CPU unit	Delta DVP
		RS485 on port	

## 6-2 Communication Parameters and Cable Fabrication

Series	CPU	Link Module	COMM Type	Parameter	Cable
DVP	DVP-XXES/EX/SS DVP-XXSA/SX/SC DVP-XXEH/EH2/SV	RS232 on the CPU unit	RS232	Refer to Section 6-3	Self-made cable required
		RS485 on port	RS485		

## 6-3 Communication Parameter Setting

### PT Settings

PT default communication parameters: 9600bps (Baud Rate), 7 (Data Bit), even (Parity Check), 1 (Stop Bit) and 1(PLC Station No.)

RS232 Communication

The screenshot shows the 'HMI Attribute' dialog box with the 'COM2 Setting' tab selected. The 'Type' is set to 'RS232'. The communication parameters are: Baud Rate: 9600, Data Bit: 7, Parity Check: even, Stop Bit: 1, and Broadcast: 65535 (unchecked). The communication time-out settings are: PLC Communication Time Out: 3, Protocol Time Out 1(ms): 30, Protocol Time Out 2(ms): 3, Max interval of word block pack: 5, Max interval of bit block pack: 16, Max size of word block package: 16, and Max size of bit block package: 64. A 'Use Default Setting' button is located at the bottom of the settings area.

Parameter	Value
Type	RS232
Baud Rate	9600
Data Bit	7
Parity Check	even
Stop Bit	1
Broadcast	65535
PLC Communication Time Out	3
Protocol Time Out 1(ms)	30
Protocol Time Out 2(ms)	3
Max interval of word block pack	5
Max interval of bit block pack	16
Max size of word block package	16
Max size of bit block package	64

RS485 Communication

The screenshot shows the 'HMI Attribute' dialog box with the 'COM1 Setting' tab selected. The 'Type' is set to 'RS485'. The communication parameters are: Baud Rate: 9600, Data Bit: 7, Parity Check: even, Stop Bit: 1, and Broadcast: 65535 (unchecked). The communication time-out settings are: PLC Communication Time Out: 3, Protocol Time Out 1(ms): 30, Protocol Time Out 2(ms): 3, Max interval of word block pack: 5, Max interval of bit block pack: 16, Max size of word block package: 16, and Max size of bit block package: 64. A 'Use Default Setting' button is located at the bottom of the settings area.

Parameter	Value
Type	RS485
Baud Rate	9600
Data Bit	7
Parity Check	even
Stop Bit	1
Broadcast	65535
PLC Communication Time Out	3
Protocol Time Out 1(ms)	30
Protocol Time Out 2(ms)	3
Max interval of word block pack	5
Max interval of bit block pack	16
Max size of word block package	16
Max size of bit block package	64

**Note** The communication parameters should be set through modification of D1120 value when RS485 communication is used.



## PLC Settings

- 1 You can check the baud rates equivalent to the value of D1120 in the dialog box, “RS-485 Protocol Setting (D1120)” after selecting [Help] menu in the Wpl207 software, and [Auxiliary Editing] in the “Help” in the Wpl207 software.

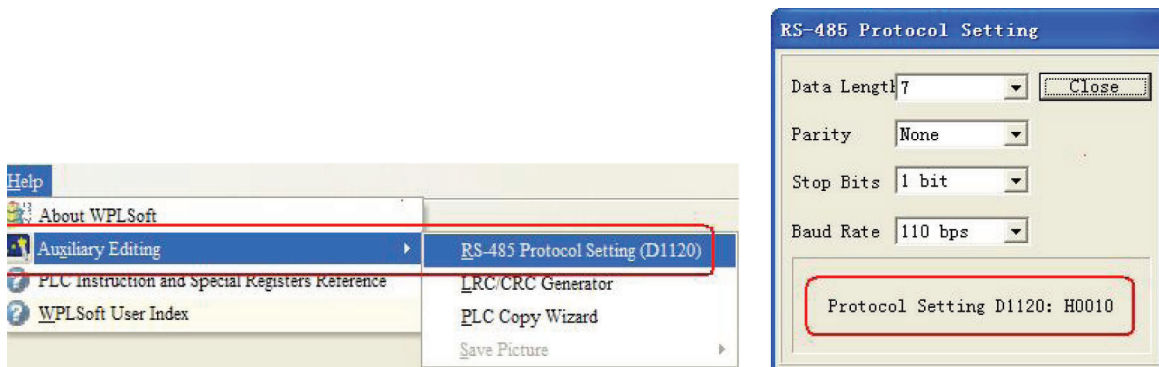

- 2 Monitor and modify the value of D1120 after PLC is connected to Wpl207.  
For example: If the communication parameters are 110bps (Baud Rate), 7 (Data Length), None (Parity) and 1 bit (Stop Bits), then D1120=H0010 (Protocol Setting).

## 6-4 Supported Registers

Device	Bit Address	Word Address	Format	Notes
External Input Nodes	X0-23417	-----	OOOOO	
External Output Nodes	Y0-23417	-----	OOOOO	
Internal Auxiliary Nodes	M0-9999	-----	DDDD	
Sequence Control Nodes	S0-9999	-----	DDDD	
Timer Nodes	T0-9999	-----	DDDD	
Counter Nodes	C0-9999	-----	DDDD	
Timer Buffers	-----	TV0-9999	DDDD	
Counter Buffers	-----	CV0-127	DDD	
Counter Buffers (double-word, 32-bit)	-----	CV2 232-255	DDD	
Data Registers	-----	D0-9999	DDDD	

**Note** Address format description: D: decimal, O: octonary, H: hexadecimal.

## 6-5 Cable Fabrication

### ● RS232 Communication Cable

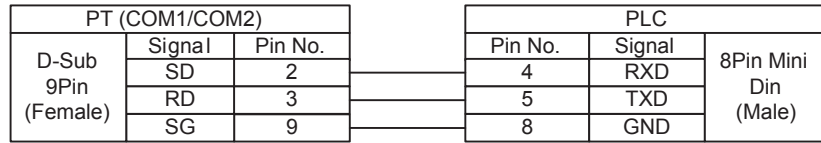

### ● RS485 Communication Cable

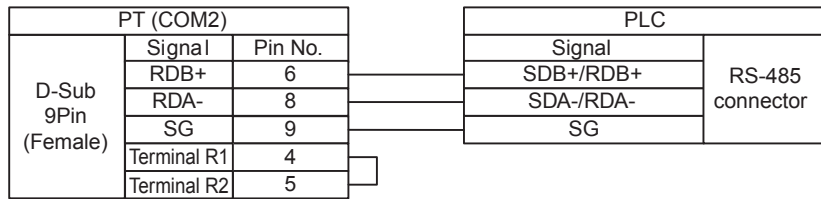



# 7

## Connecting to LSIS PLCs

This section describes the connection to LSIS PLCs

---

<b>7-1</b>	<b>Serial Port Communication</b>	<b>7-2</b>
<b>7-2</b>	<b>Communication Parameters and Cable Fabrication</b>	<b>7-3</b>
<b>7-3</b>	<b>Communication Parameter Setting</b>	<b>7-4</b>
<b>7-4</b>	<b>Supported Registers</b>	<b>7-12</b>
<b>7-5</b>	<b>Cable Fabrication</b>	<b>7-15</b>

## 7-1 Serial Port Communication

Series	Type	CPU	Link Module	Driver
Master-K	K120S	K7M-DR10UE	Port1 on CPU unit	LS Master-K CPU Direct LS Master-K Cnet LS Master-K Modbus RTU
		K7M-DR20U	Port2 on CPU unit	
		K7M-DT30U		
		K7M-DT40U		
		K7M-DT60U		
	K200S	K3P-07AS	RS232 on the CPU unit	
XGB	XBC	XBC-DN64H	RS232 on the CPU unit	LS XGT CPU Direct
		XBC-DR32H	Built-in RS-232C/RS-485	LS XGT Cnet
	XEC	XEC-DN60SU	Built-in RS-232C/RS-485	LS XEC Cnet

The differences between LS Master-K CPU Direct, LS Master-K Cnet and LS Master-K Modbus RTU protocols are as shown below:

Communication Protocol	PLC Settings	Supported Communication Methods	Multiple Station No.	Supported Baud Rate (bps)
LS Master-K Cnet	Tweak the pin 2 (up) of DIP switch to ON and pin 1 (low) of DIP switch to OFF	RS-232/RS-485	Supported	9600/19200/38400
LS Master-K MODBUS RTU	Tweak the pin 2 (up) of DIP switch to ON and pin 1 (low) of DIP switch to OFF	RS-232/RS-485	Supported	9600/19200/38400
LS Master-K CPU Direct	Pin 1 and pin 2 remain OFF	RS-232	Not supported	38400

## 7-2 Communication Parameters and Cable Fabrication

Series	CPU	Link Module	COMM Type	Parameter	Cable
K120S	K7M-DR10UE	Port1 on CPU unit	RS232	Refer to Section 7-3	Self-made cable required
		Port2 on CPU unit	RS485		
	K7M-DR20U	Port1 on CPU unit	RS232		
		Port2 on CPU unit	RS485		
K200S	K3P-07AS	RS232 on the CPU unit	RS232		
XBC	XBC-DN64H	RS232 on the CPU unit	RS232		
	XBC-DR32H	Built-in RS-232C	RS232		
		Built-in RS-485	RS485		
XEC	XEC-DN60SU	Built-in RS-232C	RS232		
		Built-in RS-485	RS485		

## 7-3 Communication Parameter Setting

### PT Settings

- **When Using LS Master-K Cnet Protocol**

PT default communication parameters: 38400bps (Baud Rate), 8 (Data Bit), none (Parity Check), 1 (Stop Bit) and 1(PLC Station No.)

RS232 Communication

The screenshot shows the 'HMI Attribute' dialog box with the 'COM1 Setting' tab selected. The 'Type' is set to 'RS232'. The communication parameters are: Baud Rate: 38400, Data Bit: 8, Parity Check: none, Stop Bit: 1, and Broadcast: 65535 (unchecked). The PLC Communication Time Out is 1. The Protocol Time Out 1(ms) is 30, and Protocol Time Out 2(ms) is 3. The Max interval of word block pack is 2, and Max interval of bit block pack is 2. The Max size of word block package is 16, and Max size of bit block package is 16. A 'Use Default Setting' button is at the bottom.

Parameter	Value
Type	RS232
Baud Rate	38400
Data Bit	8
Parity Check	none
Stop Bit	1
Broadcast	65535
PLC Communication Time Out	1
Protocol Time Out 1(ms)	30
Protocol Time Out 2(ms)	3
Max interval of word block pack	2
Max interval of bit block pack	2
Max size of word block package	16
Max size of bit block package	16

RS485 Communication

The screenshot shows the 'HMI Attribute' dialog box with the 'COM1 Setting' tab selected. The 'Type' is set to 'RS485'. The communication parameters are: Baud Rate: 38400, Data Bit: 8, Parity Check: none, Stop Bit: 1, and Broadcast: 65535 (unchecked). The PLC Communication Time Out is 1. The Protocol Time Out 1(ms) is 30, and Protocol Time Out 2(ms) is 3. The Max interval of word block pack is 2, and Max interval of bit block pack is 2. The Max size of word block package is 16, and Max size of bit block package is 16. A 'Use Default Setting' button is at the bottom.

Parameter	Value
Type	RS485
Baud Rate	38400
Data Bit	8
Parity Check	none
Stop Bit	1
Broadcast	65535
PLC Communication Time Out	1
Protocol Time Out 1(ms)	30
Protocol Time Out 2(ms)	3
Max interval of word block pack	2
Max interval of bit block pack	2
Max size of word block package	16
Max size of bit block package	16

- **When Using LS Master-K CPU Direct Protocol**

PT default communication parameters: 38400bps (Baud Rate), 8 (Data Bit), none (Parity Check), 1 (Stop Bit) and 1 (PLC Station No.)



## RS232 Communication

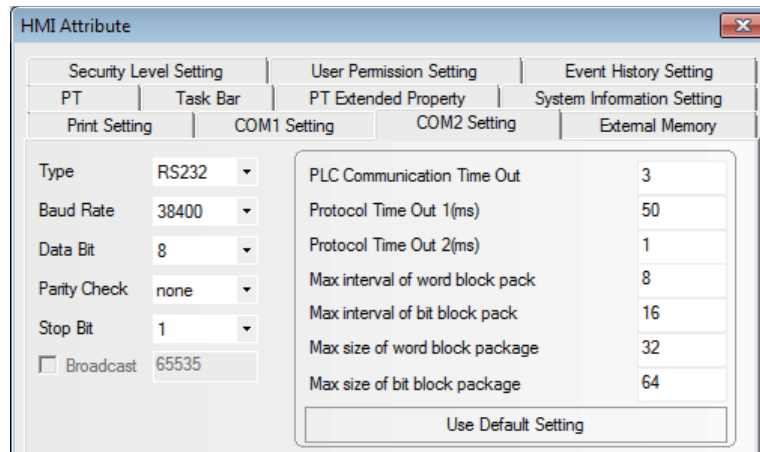

**Note** LS Master-K CPU Direct protocol only supports communication speed of 38400bps.

- **When Using LS Master-K Modbus RTU Protocol**

PT default communication parameters: 38400bps (Baud Rate), 8 (Data Bit), none (Parity Check), 1 (Stop Bit) and 1 (PLC Station No.)

## RS232 Communication

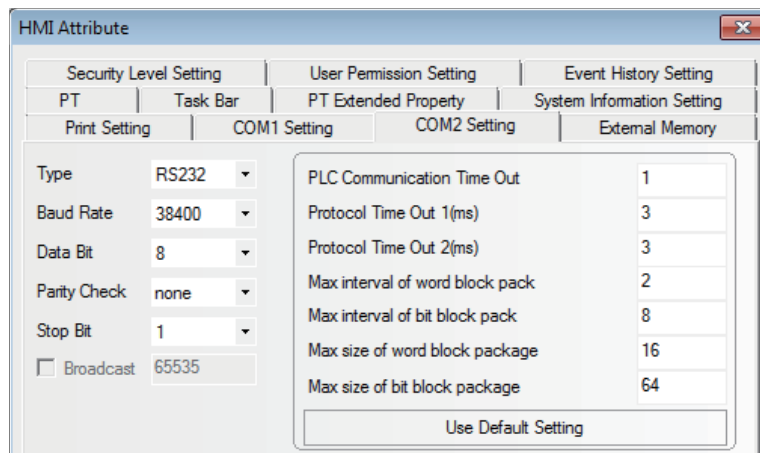

### ● When Using LS XGT CPU Direct Protocol

PT default communication parameters: 115200bps (Baud Rate), 8 (Data Bit), none (Parity Check), 1 (Stop Bit) and 0 (PLC Station No.)

RS232 Communication

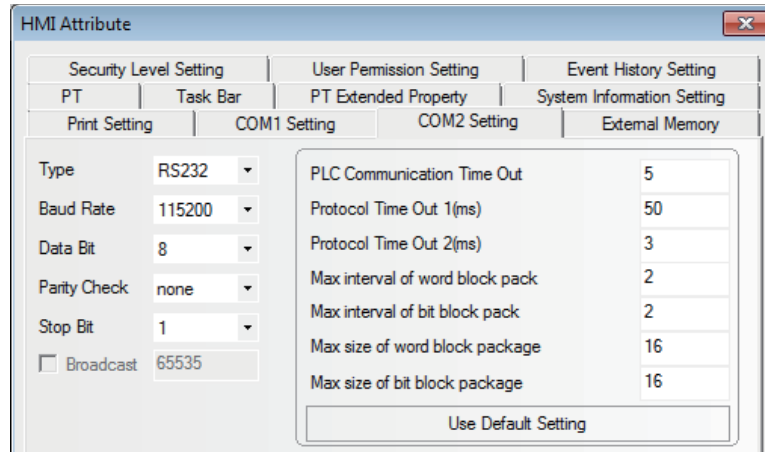

**Note** LS XGT CPU Direct protocol only supports communication speed of 115200bps and the Multiple Station No. is not supported.

### ● When Using LS XGT Cnet Protocol

PT default communication parameters: 9600bps (Baud Rate), 8 (Data Bit), none (Parity Check), 1 (Stop Bit) and 0 (PLC Station No.)

RS232 Communication

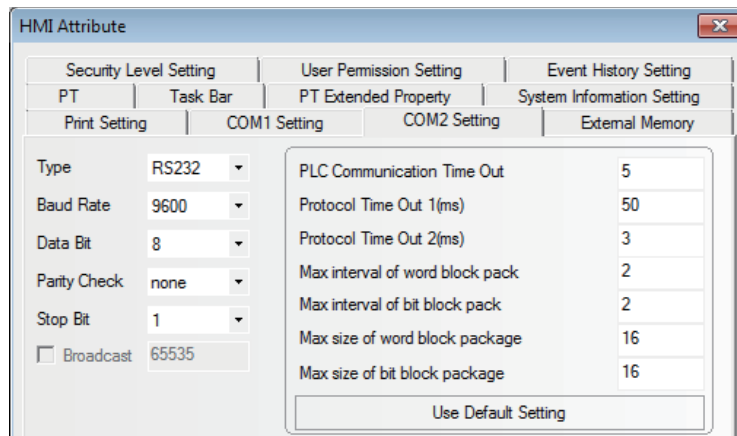

RS485 Communication

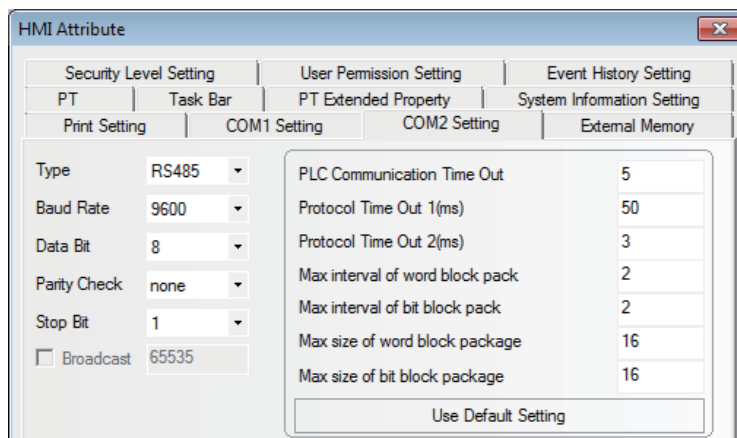

### ● When Using LS XEC Cnet Protocol

PT default communication parameters: 9600bps (Baud Rate), 8 (Data Bit), none (Parity Check), 1 (Stop Bit) and 0 (PLC Station No.)

RS232 Communication

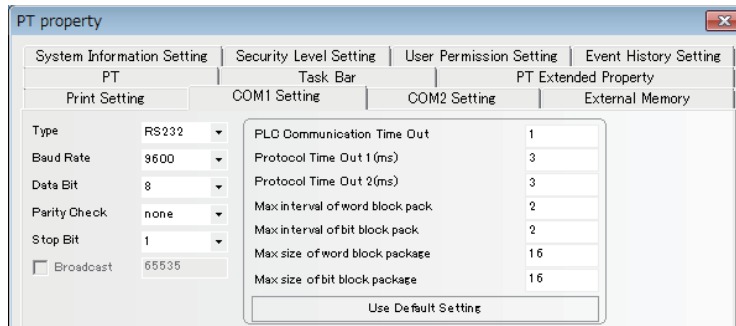

RS485 Communication

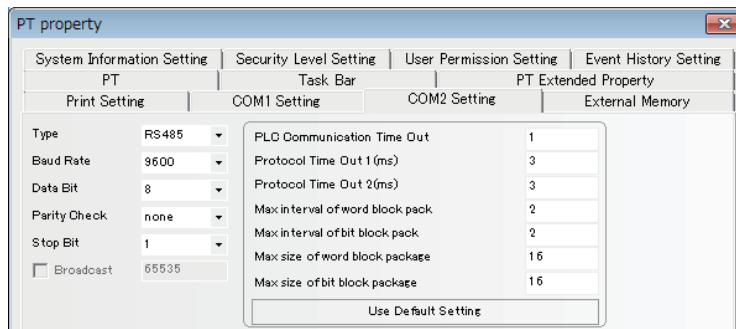

## PLC Settings

### ● When Using LS Master-K Cnet Protocol

The software settings are as shown below (Please pay attention to the settings encircled by red line.):

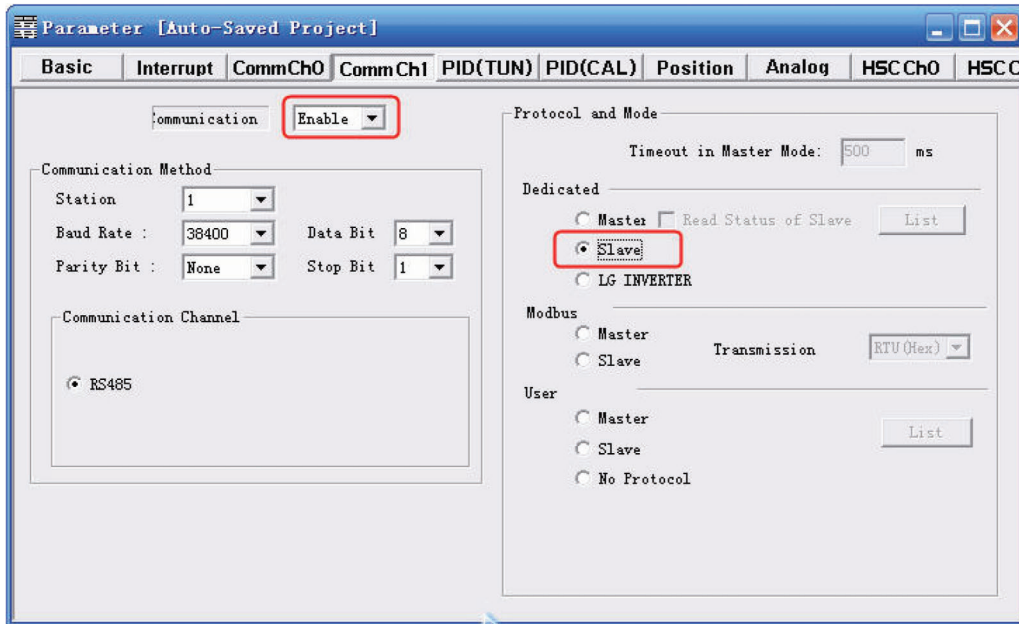

### ● When Using LS Master-K Modbus RTU Protocol

The software settings are as shown below (Please pay attention to the settings encircled by red line.):

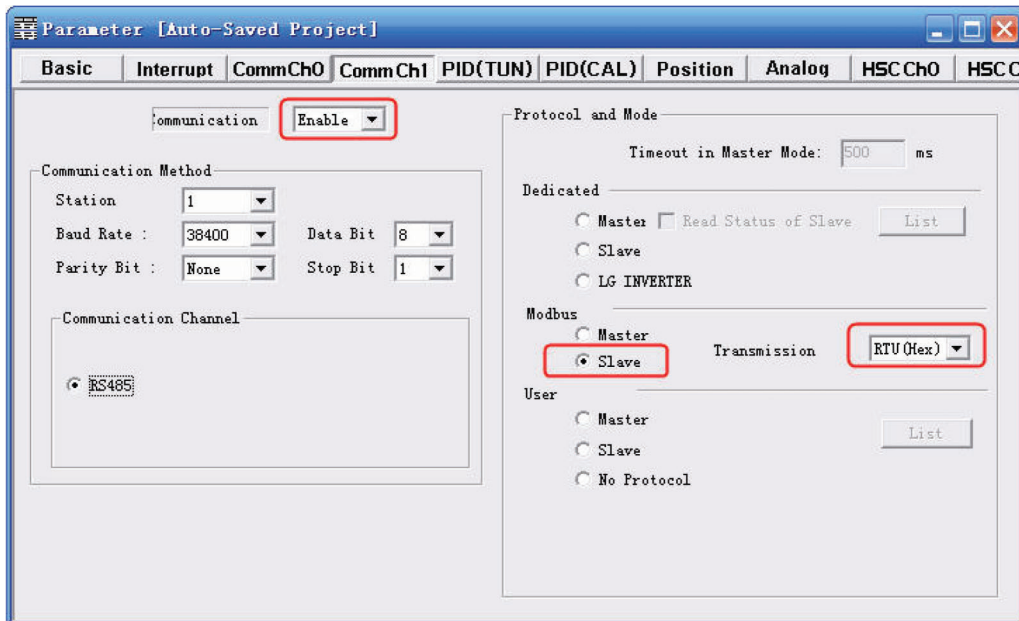

The “Cannot Change PLC Mode” will appear when [Connect+Write+Run+Monitor Start] is clicked, then manual control is needed and download operation is available only when the RUN light is OFF. After the download operation is completed, the RUN light should maintain ON.

- When Using LS XGT Cnet Protocol

- 1 Set the communication parameters through the [Tools]-[Network Manager] menu option.

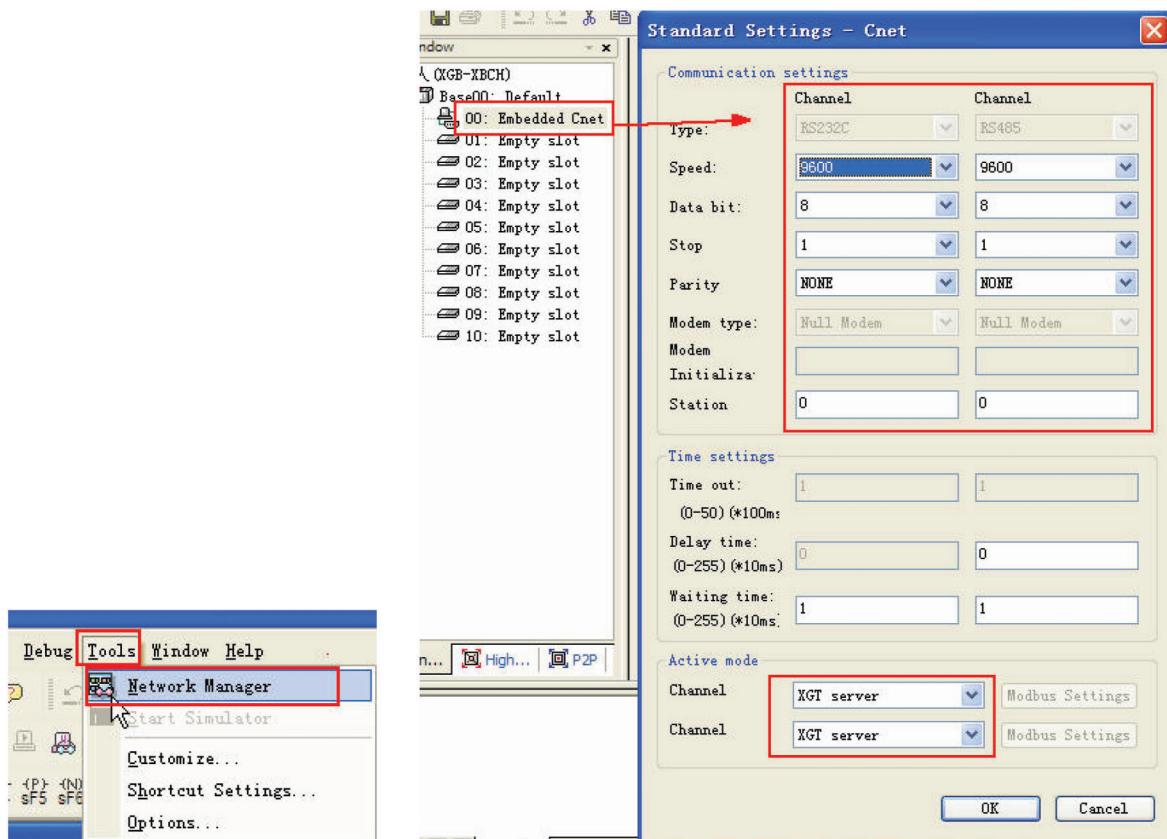

- 2 PLC must operate in [OPR] mode, which can be set on PLC

● When Using LS XEC Cnet Protocol

- 1 Right click on the [Network Configuration]-[Unspecified Network]-[PLC name] and select [Properties].

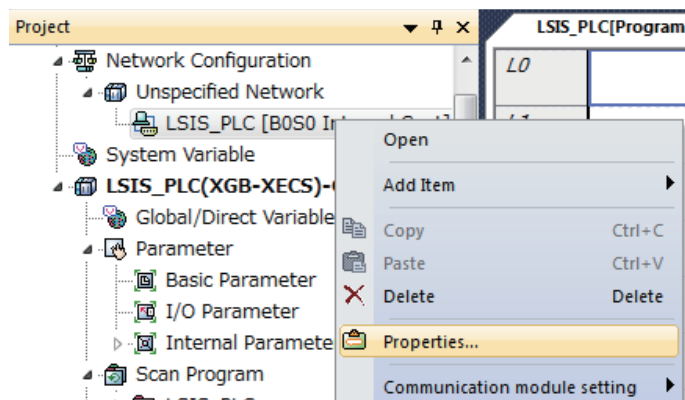

- 2 On the [Standard Settings - Cnet] window, select the [Standard Settings] tab, and set communication parameters.

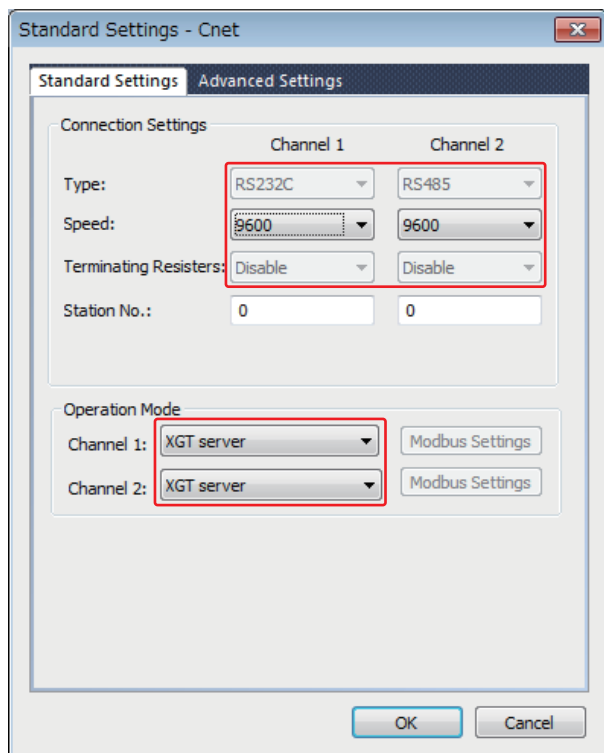

- 3** On the [Standard Settings - Cnet] window, select the [Advanced Settings] tab, and set communication parameters.

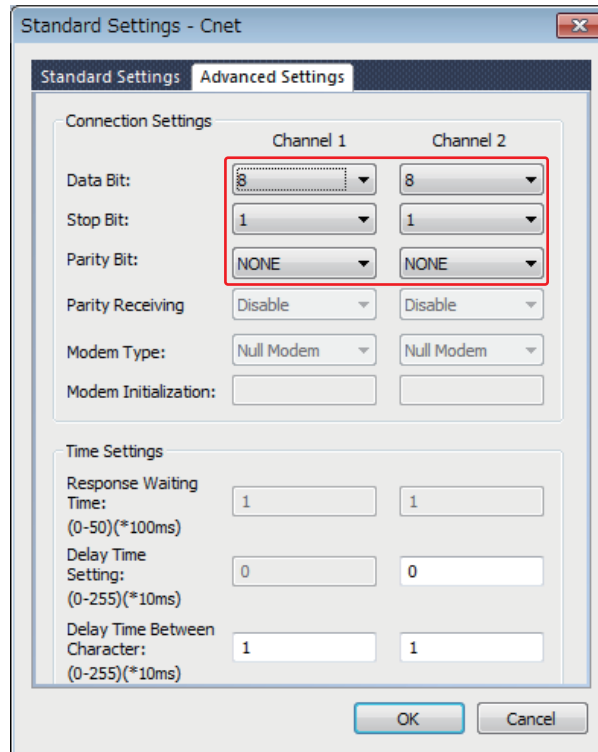

## 7-4 Supported Registers

### K120S K7M-DR10UE

Device	Bit Address	Word Address	Format	Notes
I/O Relay	P 0.0-63.f	-----	DD.H	
Auxiliary Relay	M 0.0-191.f	-----	DDD.H	
Link Relay	L 0.0-63.f	-----	DD.H	
Keep Relay	K 0.0-31.f	-----	DD.H	
Special Relay	F 0.0-31.f		DD.H	
Timer	-----	T 0-255	DDD	
Counter	-----	C 0-255	DDD	
Data Register		D 0-4999	DDDD	

**Note** For bit registers, if the address in PLC is F01, then the address in PT should be set to F0.1; and if the address in PLC is F2A, then the address in PT should be set to F2.A, and the others can be deduced according to this rule.

### LS XGT Cnet

Device	Bit Address	Word Address	Format
File Relay	R_bit 0.0-10239.F		DDDDD.H
Data Relay	D_bit 0.0-10239.F		DDDDD.H
Communication Relay	N_bit 0.0-5119.F		DDDD.H
Link Relay	L_bit 0.0-2047.F		DDDD.H
Index Relay	Z_bit 0.0-127.F	-----	DDD.H
Counter Contact Relay	C_bit 0-1023	-----	DDDD
Timer Contact Relay	T_bit 0-1023	-----	DDDD
Special Relay	F_bit 0.0-1023.F	-----	DDDD.H
Keep Relay	K_bit 0.0-4095.F	-----	DDDD.H
Auxiliary Relay	M_bit 0.0-1023.F	-----	DDDD.H
I/O Relay	P_bit 0.0-1023.F	-----	DDDD.H
File Register	-----	R_word 0-10239	DDDDD
Data Register	-----	D_word 0-10239	DDDDD
Communication Register	-----	N_word 0-5119	DDDD
Link Register	-----	L_word 0-2047	DDDD
Step Control Register		S_word 0-127	DDD
Index Register		Z_word 0-127	DDD
Counter	-----	C_word 0-1023	DDDD
Timer	-----	T_word 0-1023	DDDD
Special Register	-----	F_word 0-1023	DDDD
Keep Register	-----	K_word 0-4095	DDDD
Auxiliary Register	-----	M_word 0-1023	DDDD
I/O Register	-----	P_word 0-1023	DDDD

**Note** T\_bit and C\_bit registers do not support the communication system which requires serial addresses simultaneously.

Address format description: D: decimal, O: octonary, H: hexadecimal.



## LS XGT CPU Direct

Device	Bit Address	Word Address	Format
File Relay	R_bit 0.0-10239.F	-----	DDDDD.H
Data Relay	D_bit 0.0-10239.F	-----	DDDDD.H
Communication Relay	N_bit 0.0-5119.F	-----	DDDD.H
Link Relay	L_bit 0.0-2047.F	-----	DDDD.H
Index Relay	Z_bit 0.0-127.F	-----	DDD.H
	ZR_bit 0.0-10239.F	-----	DDDDD.H
Counter Contact Relay	C_bit 0-1023	-----	DDDD
Timer Contact Relay	T_bit 0-1023	-----	DDDD
Special Relay	F_bit 0.0-1023.F	-----	DDDD.H
Keep Relay	K_bit 0.0-4095.F	-----	DDDD.H
Auxiliary Relay	M_bit 0.0-1023.F	-----	DDDD.H
I/O Relay	P_bit 0.0-1023.F	-----	DDDD.H
File Register	-----	R 0-10239	DDDDD
Data Register	-----	D 0-10239	DDDDD
Communication Register	-----	N 0-5119	DDDD
Link Register	-----	L 0-2047	DDDD
Step Control Register	-----	S 0-127	DDD
Index Register	-----	Z 0-127	DDD
	-----	ZR 0-10239	DDDDD
Counter Set Value	-----	C_SV 0-1023	DDDD
Timer Set Value	-----	T_SV 0-1023	DDDD
Counter Current Value	-----	C_CV 0-1023	DDDD
Timer Current Value	-----	T_CV 0-1023	DDDD
Special Register	-----	F 0-1023	DDDD
Keep Register	-----	K 0-4095	DDDD
Auxiliary Register	-----	M 0-1023	DDDD
I/O Register	-----	P 0-1023	DDDD

**Note** Address format description: D: decimal, O: octonary, H: hexadecimal.

## LS XEC Cnet

Device	Bit Address	Word Address	Format
	A_bit 0-131071	-----	DDDDDD
Special Relay	F_bit 0-16383	-----	DDDDD
	W_bit 0-163839	-----	DDDDDD
File Relay	R_bit 0-163839	-----	DDDDDD
Special module Relay	U_bit 0-8191	-----	DDDD
Keep Relay	K_bit 0-65535	-----	DDDDD
Link Relay	L_bit 0-32767	-----	DDDDD
Auxiliary Relay	M_bit 0-65535	-----	DDDDD
Communication Relay	N_bit 0-163839	-----	DDDDDD
Output Relay	Q_bit 0-16383	-----	DDDDD
Input Relay	I_bit 0-16383	-----	DDDDD
	-----	A 0-8191	DDDD
Special Register	-----	F 0-1023	DDDD
	-----	W 0-10239	DDDDD

Device	Bit Address	Word Address	Format
File Register	-----	R 0-10239	DDDDD
Special module Register	-----	U 0-511	DDD
Keep Register	-----	K 0-4095	DDDD
Link Register	-----	L 0-2047	DDDD
Auxiliary Register	-----	M 0-4095	DDDD
Communication Register	-----	N 0-10239	DDDDD
Output Register	-----	Q 0-1023	DDDD
Input Register	-----	I 0-1023	DDDD

**Note** Communication Relay / Register is not supported on the SU type.



### Additional Information

- The address format of %UX is D.DD.DDD (0.0.0-0.15.511) in the PLC, it corresponds to DDDD (0-8191) in the HMI. And the %UX 0.m.n in the PLC is U\_Bit  $m \times 512 + n$  in the HMI. Similarly, the %UW 0.0.0-0.15.31 in the PLC corresponds to U 0-511 in the HMI. And the %UW 0.m.n in the PLC is U  $m \times 32 + n$ .

For example,

Internal address: %UX 0.1.0 in the PLC corresponds to U\_Bit 512 in the HMI.

Internal address: %UX 0.15.511 in the PLC corresponds to U\_Bit 8191 in the HMI.

Internal address: %UW 0.1.0 in the PLC corresponds to U 32 in the HMI.

Internal address: %UW 0.15.31 in the PLC corresponds to U 511 in the HMI.

- The address format of %QX / IX is DD.DD.DD (0.0.0-15.15.63) in the PLC, it corresponds to DDDDD (0-16383) in the HMI. And the %QX / IX a.b.c in the PLC is Q\_Bit / I\_Bit  $a \times 1024 + b \times 64 + c$  in the HMI.

Similarly, the %QW / IW 0.0.0-15.15.3 in the PLC corresponds to Q/I 0-1023 in the HMI. And the %QW / IW a.b.c in the PLC is Q / I  $a \times 64 + b \times 4 + c$ .

For example,

Internal address: %QX / IX 0.1.0 in the PLC corresponds to Q\_Bit / I\_Bit 64 in the HMI.

Internal address: %QX / IX 15.15.63 in the PLC corresponds to Q\_Bit / I\_Bit 16383 in the HMI.

Internal address: %QW / IW 0.1.0 in the PLC corresponds to Q / I 4 in the HMI.

Internal address: %QW / IW 15.15.3 in the PLC corresponds to Q / I 1023 in the HMI.

## 7-5 Cable Fabrication

### When Using LS Master-K Cnet/LS Master-K Modbus RTU Protocol

#### ● RS232 Communication Cable

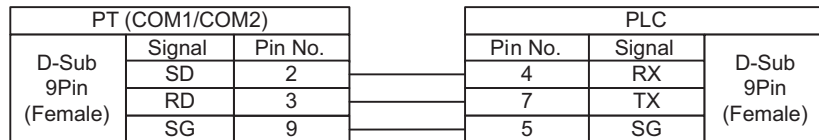

#### ● RS485 Communication Cable

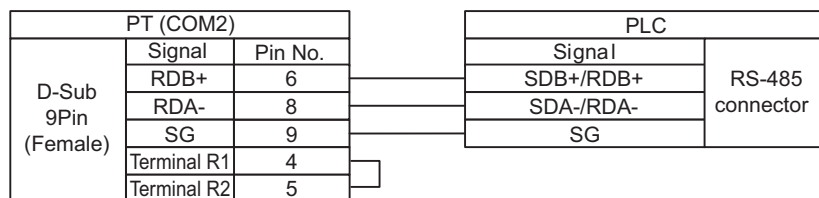

### When Using LS Master-K CPU Direct Protocol

#### ● RS232 Communication Cable

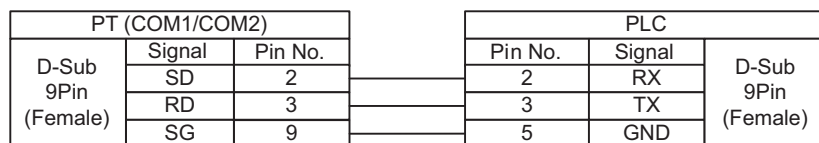

### When Using LS XGT CPU Direct Protocol

#### ● RS232 Communication Cable

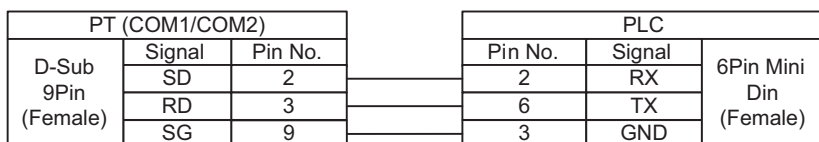

## When Using LS XGT / XEC Cnet Protocol

### ● RS232 Programming Cable

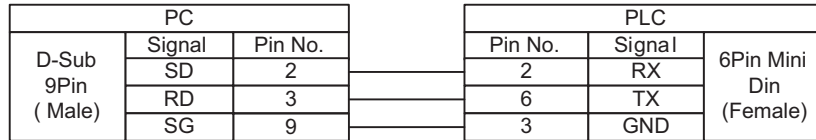

### ● RS232 Communication Cable

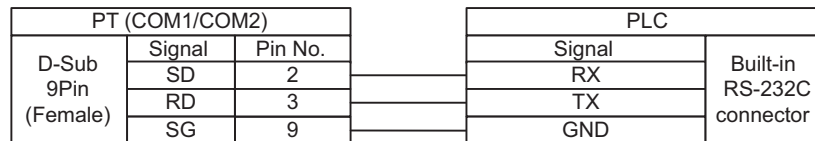

### ● RS485 Communication Cable

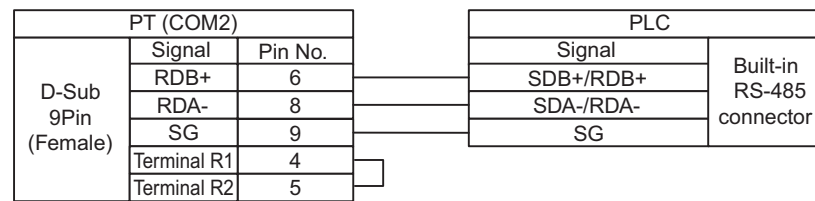

### Precautions for Correct Use

For RS422/485, a terminating resistance short circuit is required. A short-circuit may depend on an NB model. Thus, please refer to *1-2 Part Specifications* in the *NB-series Programmable Terminals Setup Manual* (Cat. No. V107).

# 8

## Connecting to Panasonic Industrial Devices SUNX PLCs

This section describes the connection to Panasonic Industrial Devices SUNX PLCs.

---

<b>8-1</b>	<b>Serial Port Communication</b> .....	<b>8-2</b>
<b>8-2</b>	<b>Communication Parameters and Cable Fabrication</b> .....	<b>8-3</b>
<b>8-3</b>	<b>Communication Parameter Setting</b> .....	<b>8-4</b>
<b>8-4</b>	<b>Supported Registers</b> .....	<b>8-5</b>
<b>8-5</b>	<b>Cable Fabrication</b> .....	<b>8-6</b>

## 8-1 Serial Port Communication

Series	CPU	Link Module	Driver	
FP	FP	Tool port on the Control unit	Panasonic FP	
		AFPG801		
		AFPG802		
		AFPG803		
		AFPG806		
	FP0 FP1 FP-M	Tool port on the Control unit		
		RS232C port on the Control unit		
	FP2 FP2SH	Tool port on the Control unit		
		RS232C port on the Control unit		
		AFP2462		
		AFP2465+(AFP2803,AFP2804, FP2805)		
	FP3	Tool port on the Control unit		
		AFP3462		
	FP-e	Tool port on the Control unit		
		AFPE224300		
		AFPE224302		
		AFPE224305		
		AFPE214322		
		AFPE214325		
	FP10SH FP10S	Tool port on the Control unit		
		RS232C port on the Control unit		
		AFP3462		
	FP-X	RS232C port on the Control unit		

## 8-2 Communication Parameters and Cable Fabrication

Series	CPU	Link Module	COMM Type	Parameter	Cable
FP	FP	Tool port on the Control unit	RS232C	Refer to Section 8-3	Self-made cable required
		AFPG801			
		AFPG802			
		AFPG806	RS485		
		AFPG803			
		AFPG806			
	FP0	Tool port on the Control unit	RS232C		
		RS232C port on the Control unit			
	FP1 FP-M	Tool port on the Control unit	RS232C		
		RS232C port on the Control unit			
	FP2 FP2SH	Tool port on the Control unit	RS232C		
		RS232C port on the Control unit			
		AFP2462			
		AFP2465	AFP2803	RS422	
			AFP2804		
	AFP2805	RS485			
	FP3	Tool port on the Control unit	RS232C		
		AFP3462			
		AFP3463	RS422		
	FP-e	Tool port on the Control unit	RS232C		
		AFPE224300	RS232C		
AFPE214325					
AFPE224305					
AFPE224302		RS485			
AFPE214322					
FP10SH FP10S	Tool port on the Control unit	RS232C			
	RS232C port on the Control unit				
	AFP3462				
FP-X	RS232C port on the Control unit	RS232C			

- Note 1** Only FP0 (C10CRM/C10CRS/C14CRM/C14CRS/C16T/C16CP/C32CT/C32CP) has RS232C communication port.
- 2** Only FP1 (C24/C40/C56/C72) has RS232C communication port.
- 3** Only FP1 (C20R/C20T/C32T) has RS232C communication port.
- 4** AFP245 is the multi-communication unit for FP2/FP2SH. AFP2803, AFP2804 and AFP2805 are the communication modules connecting to AFP2465.

## 8-3 Communication Parameter Setting

### PT Settings

PT default communication parameters: 9600bps (Baud Rate), 8 (Data Bit), odd (Parity Check), 1 (Stop Bit) and 1 (PLC Station No.)

RS232 Communication

Security Level Setting		User Permission Setting		Event History Setting	
PT		Task Bar		PT Extended Property	
Print Setting		COM1 Setting		COM2 Setting	
				External Memory	
Type	RS232	PLC Communication Time Out	3		
Baud Rate	9600	Protocol Time Out 1(ms)	50		
Data Bit	8	Protocol Time Out 2(ms)	0		
Parity Check	odd	Max interval of word block pack	8		
Stop Bit	1	Max interval of bit block pack	128		
<input type="checkbox"/> Broadcast	65535	Max size of word block package	16		
		Max size of bit block package	256		
Use Default Setting					

RS485 Communication

Security Level Setting		User Permission Setting		Event History Setting	
PT		Task Bar		PT Extended Property	
Print Setting		COM1 Setting		COM2 Setting	
				External Memory	
Type	RS485	PLC Communication Time Out	3		
Baud Rate	9600	Protocol Time Out 1(ms)	50		
Data Bit	8	Protocol Time Out 2(ms)	0		
Parity Check	odd	Max interval of word block pack	8		
Stop Bit	1	Max interval of bit block pack	128		
<input type="checkbox"/> Broadcast	65535	Max size of word block package	16		
		Max size of bit block package	256		
Use Default Setting					

RS422 Communication

Security Level Setting		User Permission Setting		Event History Setting	
PT		Task Bar		PT Extended Property	
Print Setting		COM1 Setting		COM2 Setting	
				External Memory	
Type	RS422	PLC Communication Time Out	3		
Baud Rate	9600	Protocol Time Out 1(ms)	50		
Data Bit	8	Protocol Time Out 2(ms)	0		
Parity Check	odd	Max interval of word block pack	8		
Stop Bit	1	Max interval of bit block pack	128		
<input type="checkbox"/> Broadcast	65535	Max size of word block package	16		
		Max size of bit block package	256		
Use Default Setting					

### PLC Settings

Please refer to relevant instruction manual of communication device on parameter settings.



## 8-4 Supported Registers

### FP0-C16

Device	Bit Address	Word Address	Format	Notes
External Output Nodes	Y0.0-12.F	---	DD.H	
External Input Nodes	X0.0-12.F	---	DD.H	
Timer Nodes	T0-99	---	DD	
Counter Nodes	C100-143	---	DDD	
Internal Auxiliary Nodes	R0.0-62.F R900.0-903.F	---	DD.H DDD.H	
Setting Value Registers for Timer/Counter	---	SV0-143	DDD	
Actual Value Registers for Timer/Counter	---	EV0-143	DDD	
Data Registers	---	DT0-1659	DDDD	

### FPX

Device	Bit Address	Word Address	Format	Notes
External Input Nodes	X0.0~109.F	---	DDD.H	
External Output Nodes	Y0.0~109.F	---	DDD.H	
Timers	T0~1007	---	DDDD	
Counters	C1008~1023	---	DDDD	
Link Nodes	L0.0~127.F	---	DDD.H	
Internal Nodes	R0.0~255.F R900.0~911.F	---	DDD.H	
Actual Value Registers for Timer/Counter	---	EV0-1023	DDDD	
Setting Value Register for Timer/Counter	---	SV0-1023	DDDD	
Data Registers	---	DT0-32764	DDDDD	

**Note 1** For X registers, if the address in PLC is X01, then the address in PT should be set to X0.1; and if the address in PLC is X1F, then the address in PT should be set to X1.F and Y, R registers can be deduced according to this rule.

**2** The range of Actual Value Registers for Timer/Counter of the PT can be specified to 32767 at max, while the NB series devices support to 9999 at max.

**3** Address format description: D: decimal, O: octal, H: hexadecimal.

# 8-5 Cable Fabrication

## ● RS232 Communication Cable

- Tool port

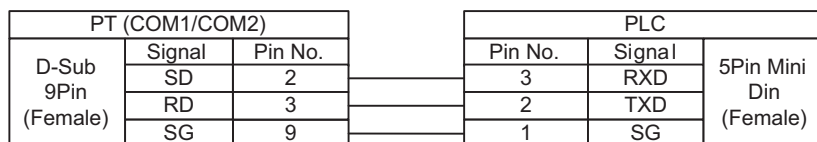

- CPU port

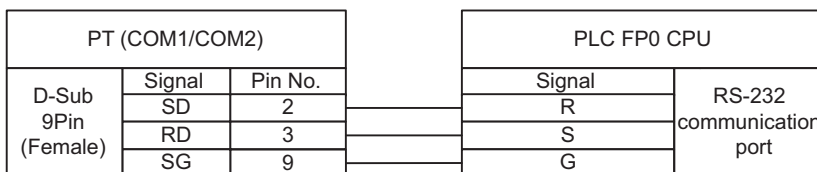

- COM port

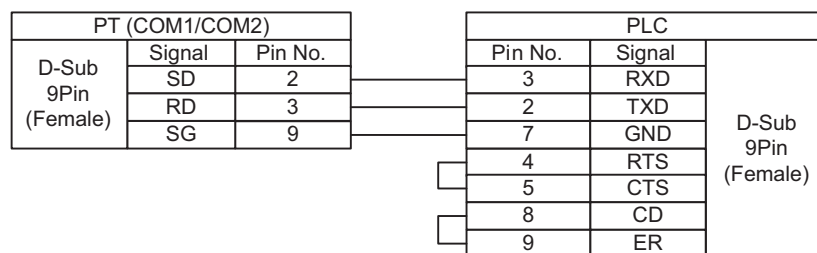

## ● RS485 Communication Cable

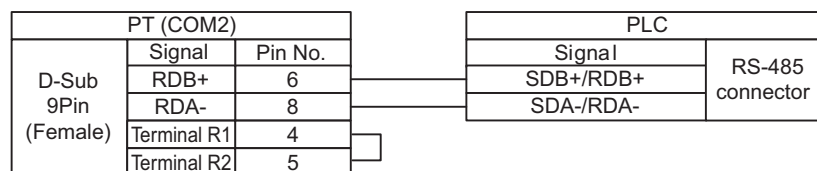

● **RS422 Communication Cable**

- FP3 RS422 programming port

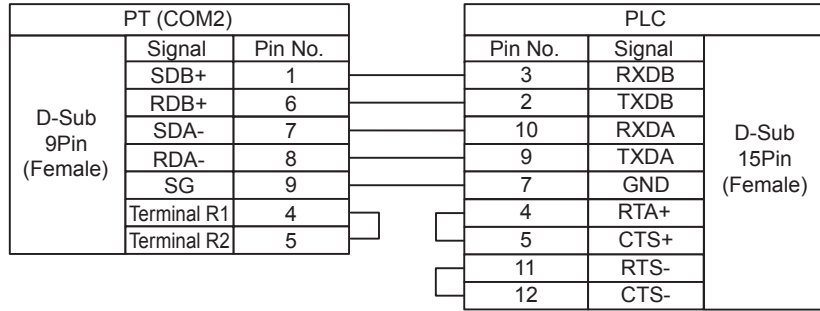

- RS422 communication port for other modules

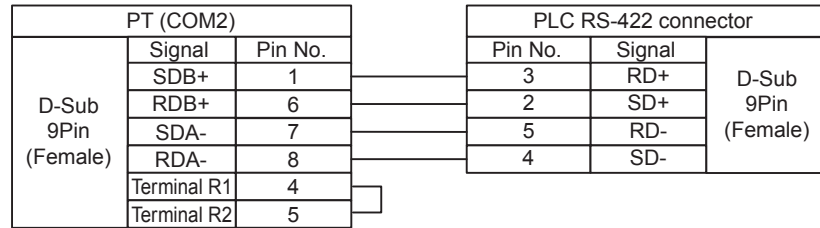



# 9

## Connecting to Allen-Bradley (Rockwell) PLC

This section describes the connection to Allen-Bradley PLC.

---

<b>9-1</b>	<b>Serial Port Communication and Ethernet</b> .....	<b>9-2</b>
9-1-1	Serial Port .....	9-2
9-1-2	Ethernet .....	9-3
<b>9-2</b>	<b>Communication Parameters and Cable Fabrication</b> .....	<b>9-4</b>
9-2-1	Serial Port .....	9-4
9-2-2	Ethernet .....	9-4
<b>9-3</b>	<b>Communication Parameter Setting</b> .....	<b>9-5</b>
9-3-1	When Using AB SLC500/MicroLogix Series (DF1) Protocol .....	9-5
9-3-2	When Using AB CompactLogix/ControlLogix Series (DF1) Protocol .....	9-7
9-3-3	AB MicroLogix Series Ethernet(TCP Slave) .....	9-11
<b>9-4</b>	<b>Supported Registers</b> .....	<b>9-14</b>
<b>9-5</b>	<b>Cable Fabrication</b> .....	<b>9-16</b>

# 9-1 Serial Port Communication and Ethernet

## 9-1-1 Serial Port

Series	CPU	Link Module	Driver
MicroLogix	MicroLogix 1500 (1764-LRP)	Channel 1	AB SLC500/MicroLogix Series (DF1)
	MicroLogix 1000 MicroLogix 1200 MicroLogix 1500 (1764-LSP, 1764-LRP)	Channel 0	
		AIC + Advanced Interface Converter 1761-NET-AIC	
	MicroLogix 1400 (1766-L32BWAA)	Channel 0 Channel 2	
SLC500	SLC 5/03 SLC 5/04 SLC 5/05	Channel 0	
		1770-KF3 2760-RB 1775-KA 5130-RM	
		1771-KGM	
CompactLogix	1769-L20 1769-L30 1769-L31 1769-L32E 1769-L35E	Channel 0	AB CompactLogix/ControlLogix Series (DF1)
		Channel 1	
ControlLogix	1756-L61 1756-L63	CPU Direct	

## 9-1-2 Ethernet

Series	CPU	Link Module	Driver
MicroLogix	MicroLogix 1100	Ethernet port on CPU Unit	AB MicroLogix Series Ethernet (TCP Slave)
	MicroLogix 1400		
	MicroLogix 1000	Communication Module 1761-NET-ENI	
	MicroLogix 1200		
	MicroLogix 1400		
	MicroLogix 1500		

## 9-2 Communication Parameters and Cable Fabrication

### 9-2-1 Serial Port

Series	CPU	Link Module	COMM Type	Parameter	Cable
MicroLogix	MicroLogix 1500 (1764-LRP)	Channel 1	RS232C	Refer to Section 9-3	Self-made cable required
	MicroLogix 1000	Channel 0			
	MicroLogix 1200	AIC +Advanced Interface Converter 1761-NET-AIC			
	MicroLogix 1500(1764-LSP, 1764-LRP)				
MicroLogix 1400(1766-L32BWAA)	Channel 0				
		Channel 2			
SLC500	SLC 5/03	Channel 0	RS232C		
	SLC 5/04	1770-KF3			
	SLC 5/05	2760-RB 1775-KA 5130-RM 1771-KGM			
CompactLogix	1769-L20	Channel 0	RS232C		
	1769-L30	Channel 1			
	1769-L31				
	1769-L32E				
	1769-L35E				
ControlLogix	1756-L61	CPU Direct	RS232C		

### 9-2-2 Ethernet

Series	CPU	Link Module	COMM Type	Parameter	Cable
MicroLogix	MicroLogix 1100	Ethernet port on CPU Unit	-	Refer to Section 9-3	Network Cable
	MicroLogix 1400				
	MicroLogix 1000	Communication Module 1761-NET-ENI	-		
	MicroLogix 1200				
	MicroLogix 1400				
MicroLogix 1500					



## 9-3 Communication Parameter Setting

### 9-3-1 When Using AB SLC500/MicroLogix Series (DF1) Protocol

#### PT Settings

MicroLogix default communication parameters: 19200 (Baud Rate), 8 (Data Bit), none (Parity), 1 (Stop Bit) and 0 (Station No.)

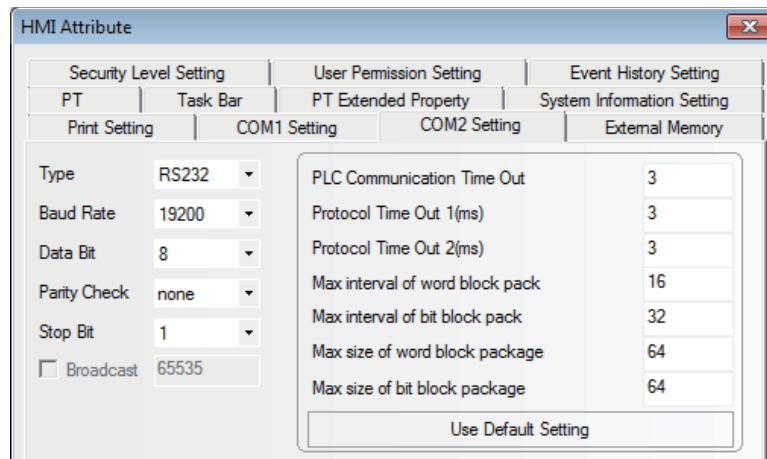

SLC500 default communication parameters: 9600 (Baud Rate), 8 (Data Bit), none (Parity), 1 (Stop Bit) and 0 (Station No.)

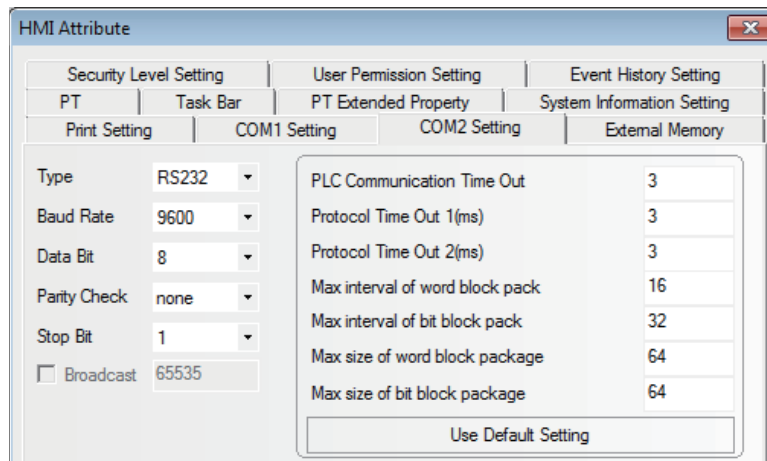

## PLC Settings

- RSLogix500 software setting (Take MicroLogix 1500 as example)

Select the “DF1 Full Duplex” for Driver option and “CRC” for the [Error Detection] option in the Channel Configuration dialog box of the software.

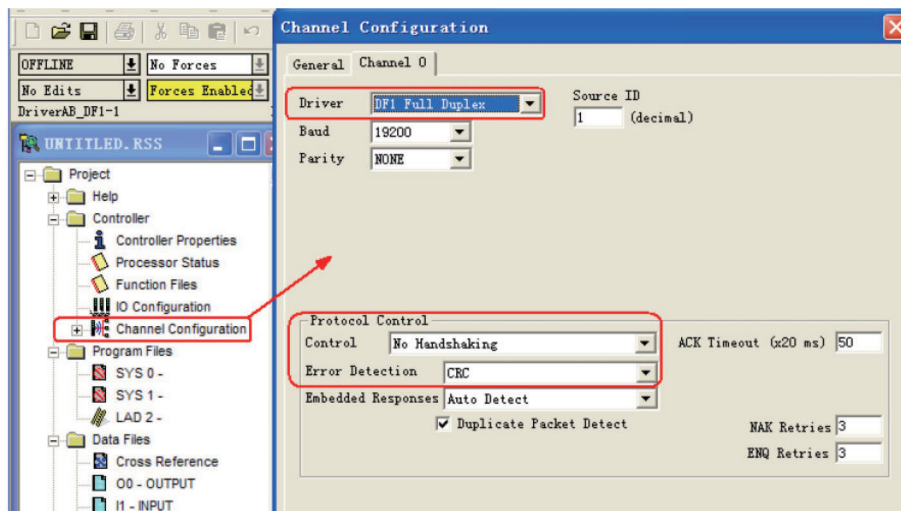

And the register setting is also available.

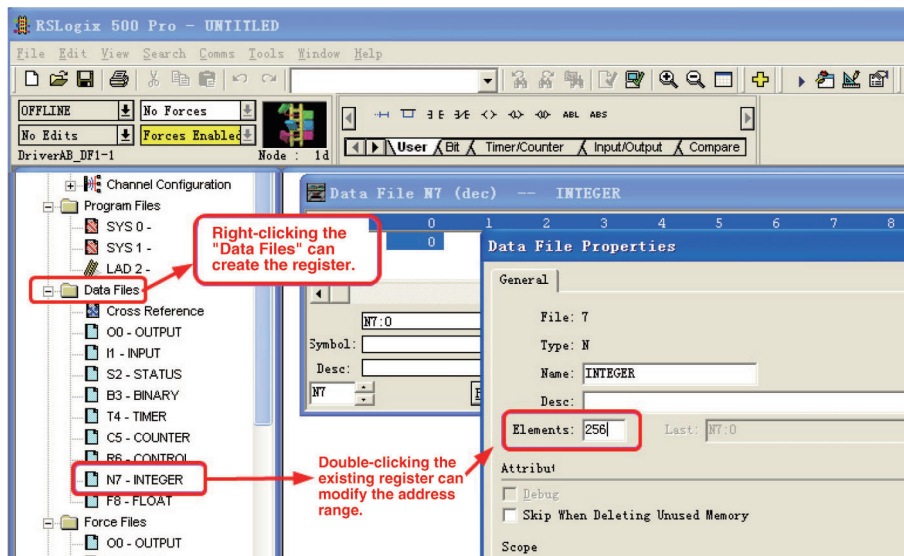

Rules of register setting:

- (1) The file number should be unique. This number is set when the register is created, and after the creation, the file number will be fixed and therefore cannot be modified.
- (2) The range of PLC addresses should be greater than the settings of the PT.
- (3) The PLC has a limited memory capacity. During downloading, if a message “Program has errors, cannot download” pops up, it indicates the occurrence of an over-range caused by too many addresses allocation.
- (4) T and C areas do not support the communication system which requires serial addresses simultaneously.

## 9-3-2 When Using AB CompactLogix/ControlLogix Series (DF1) Protocol

### PT Settings

CompactLogix/ControlLogix default communication parameters: 19200 (Baud Rate), 8 (Data Bit), none (Parity), 1 (Stop Bit) and 0 (Station No.)

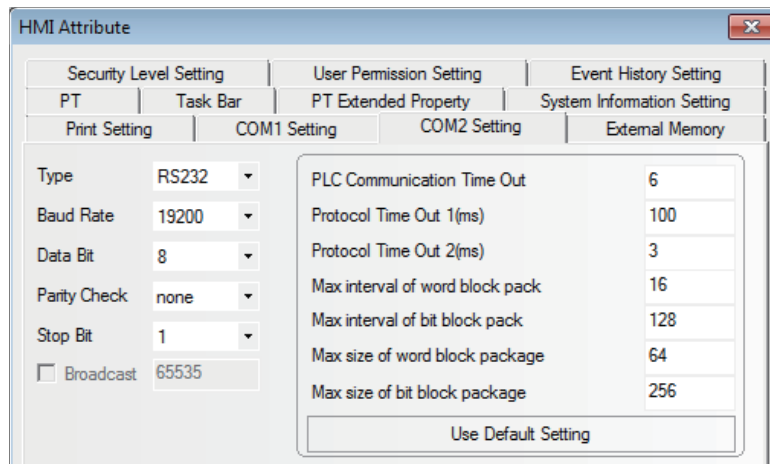

## PLC Settings

- RSLogix5000 Software Settings

**Note** “DF1 Point to Point” is selected as Protocol; “CRC” is selected as Error Detection and “Enable Duplicate Detection” is not checked.

**1** Set the parameters of the communications in [Controller Properties] dialog box.

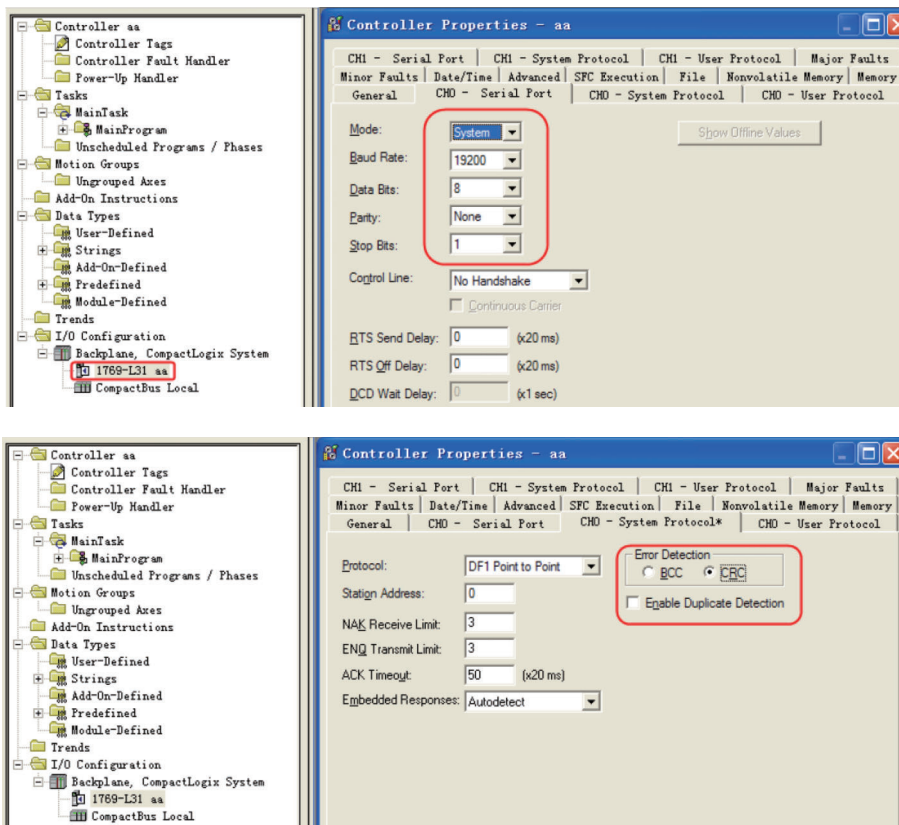

**2** Define the tag and set the data types, then select “Controller Tags” and right-click the “New Tag” option in the dropdown list to create a new tag.

**Note 1** The internal registers of the controller to be accessed by the PT needs to be pre-defined in the RSLogix5000 software.

**2** Controller Tags apply to all the routines in the controller. For the control, these tags are global, so they need to be created in “Controller Tags”.

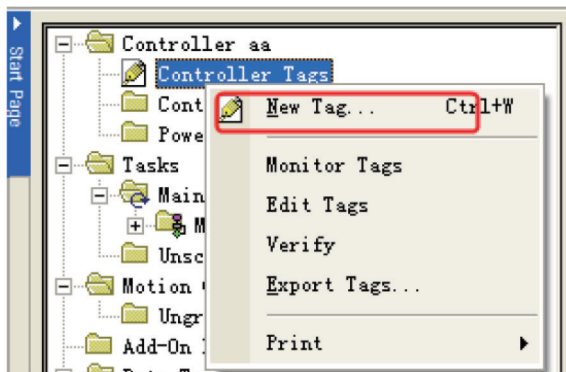

**3** Make the Name correspond to the File Number, and then select “Map PLC/SLC Messages” in the dropdown list after “Logic” being selected.

**Note** The software must be changed to “Offline” status.

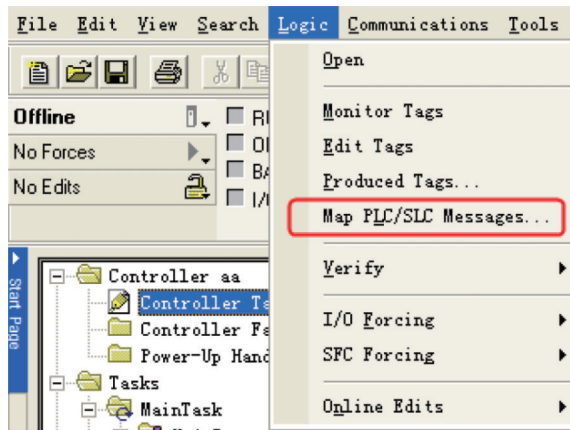

- Setting Example

Create a new tag with Name of a and Data Type of INT.

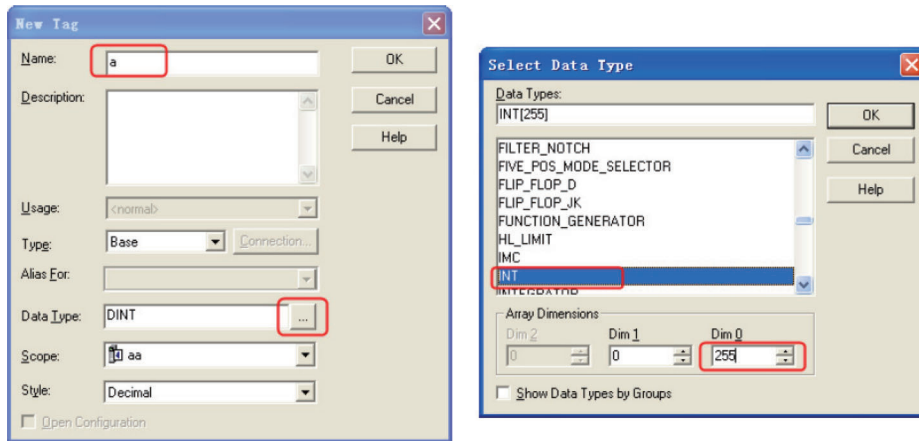

- Note 1** When selecting the Data Type, note that the CompactLogix/ControlLogix protocol supports only 3 Data Types such as INT, BOOL, and REAL.
- 2 The protocol does not support multidimensional array. Only the range of Dim0 can be defined.
  - 3 The range of file number supported by each Data Type is 0 to 253 for INT, 0 to 253 for REAL, and 0 to 999 for BOOL.

Continue to create 2 tags: one with Name of b and Data Type of REAL and the other with name of c and Data Type of BOOL, as shown below:

Name	Value	Force Mask	Style	Data Type	Description
a		{...}	{...}	INT[255]	
b		{...}	{...}	REAL[255]	
c		{...}	{...}	BOOL[1024]	

**Note** The address range of BOOL variable is defined to 1024 in the PLC, however, the accessible address range is to 999 at max.

After defining the tags, you also need to make the mapping between the Name and the File Number.

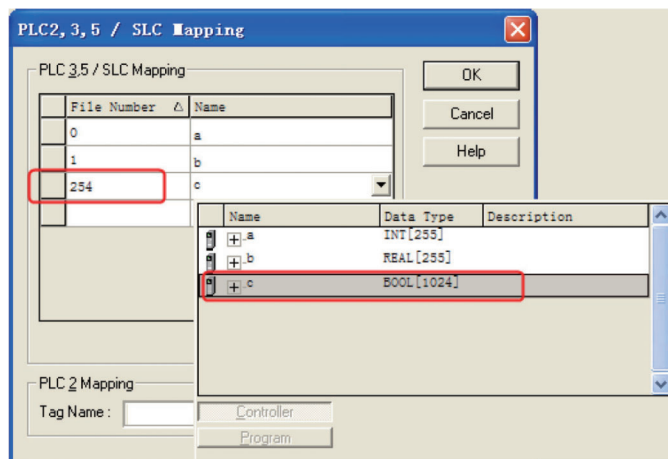

- Note 1** The file number should be unique, i.e., the same file number cannot be mapped on the different file names.
- 2** The file number available to be supported ranges from 0 to 254.

The mapping of the above-mentioned items with NB-Designer addresses is shown as the following table.

Name	Data Type	Support Range	File Number	NB-Designer Address
a	INT[255]	0~254	0	INT 000000~000254
s	REAL[255]	0~254	1	REAL 001000~001254
b	BOOL[1024]	0~999	254	B_BOOL 254000~254999

**9-3-3 AB MicroLogix Series Ethernet(TCP Slave)**

**PT Settings**

The Network Settings of PT are as shown below.

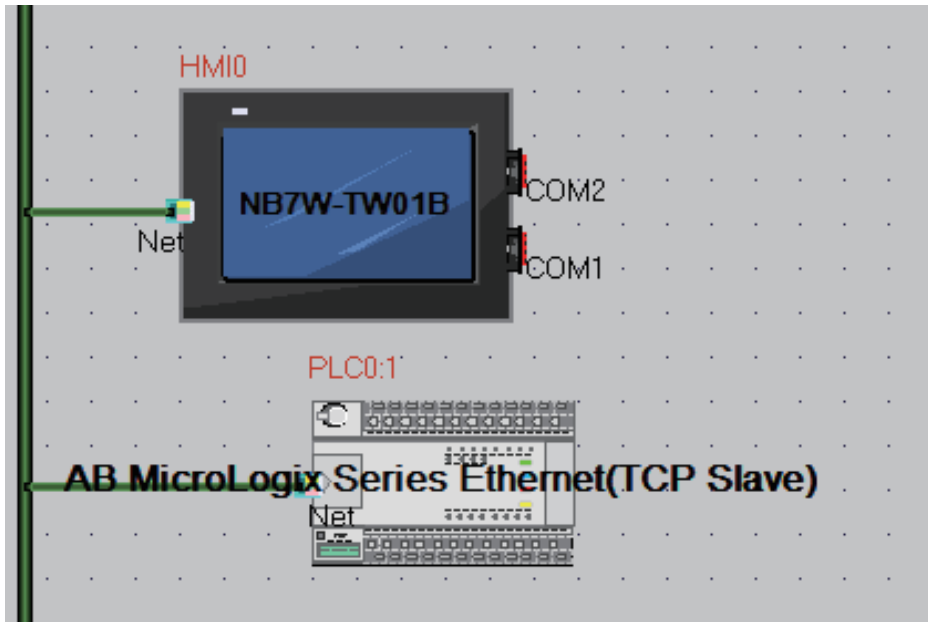

Network device setting

Device	IP Addr	Port	Protocol	Master/Sla...	Station ...	Virtual PLC...
HMI0	192.168.250.1	44818	AB MicroL...	M		
PLC0	192.168.250.2	44818	AB MicroL...	S	1	

Buttons: Add, Delete, Delete All, Modify, OK

## PLC Settings

The PLC Settings when using Communication Protocol AB MicroLogix Series Ethernet (TCP Slave) are as shown below.

### ● Using Ethernet port on CPU Unit

- 1 Start-up RSLogix 500 and double-click [Channel Configuration].

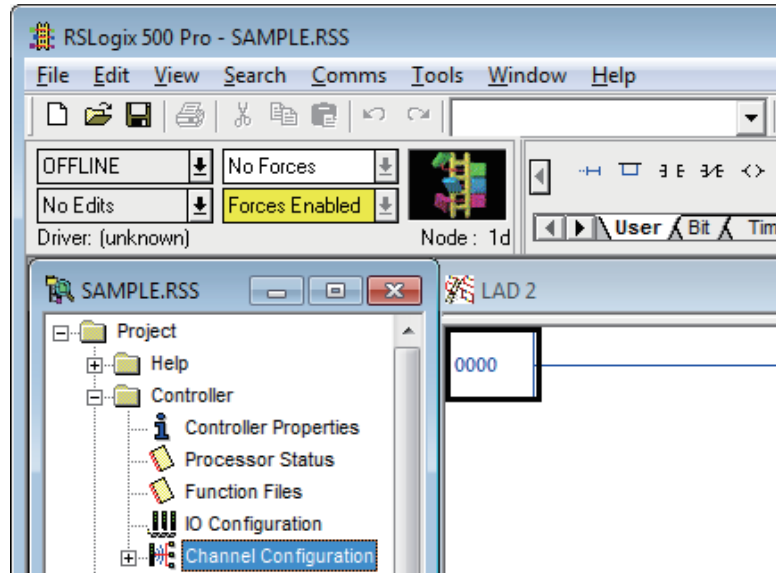

- 2 Select the tab of a channel to which Ethernet port is allocated.  
Set the IP Address to the same address as the PT settings.

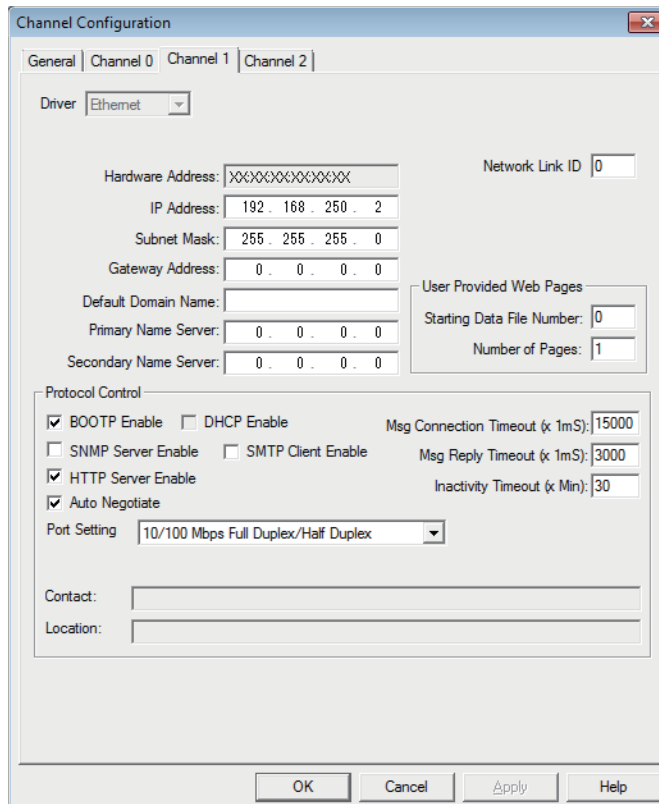



- **Using the Communication Module**

- 1** Start-up ENI/ENIW Utility.

Set the IP Address to the same parameters as the PT settings.

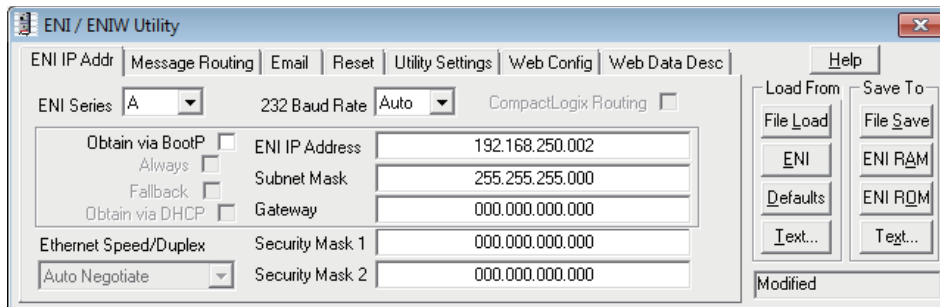

- 2** Click ENI ROM to save the settings.

## 9-4 Supported Registers



### Additional Information

FFF refers to the File Number and DDD refers to the Variable No. Address.

#### AB SLC500/MicroLogix Series (DF1) Driver

Device	Bit Address	Word Address	Format	Notes
Internal Auxiliary Nodes	B3: 0.0~255.15	-----	DDD.DD	
Internal Auxiliary Nodes	B10: 0.0~255.15	-----	DDD.DD	
Internal Auxiliary Nodes	B11: 0.0~255.15	-----	DDD.DD	
Internal Auxiliary Nodes	B12: 0.0~255.15	-----	DDD.DD	
Internal Auxiliary Nodes	B13: 0.0~255.15	-----	DDD.DD	
Internal Auxiliary Nodes	Bf:n 0.0~255.15	-----	FFFDDD.DD	*2
External Input Nodes	I1: 0.0~255.15	-----	DDD.DD	
External Output Nodes	O0: 0.0~255.15	-----	DDD.DD	
Data Registers	-----	N7: 0~255	DDD	
Data Registers	-----	N10: 0~255	DDD	
Data Registers	-----	N11: 0~255	DDD	
Data Registers	-----	N12: 0~255	DDD	
Data Registers	-----	N13: 0~255	DDD	
Data Registers	-----	N14: 0~255	DDD	
Data Registers	-----	N15: 0~255	DDD	
Data Registers	-----	Nf:n 0~255.15	FFFDDD	*2
Floating-point Data Registers	-----	F8: 0~255	DDD	
Actual Value Registers for Counter	-----	C5PV: 0~255	DDD	
Setting Value Register for Counter	-----	C5SV: 0~255	DDD	
Actual Value Registers for Timer	-----	T4PV: 0~255	DDD	
Setting Value Registers for Timer	-----	T4SV: 0~255	DDD	

**Note 1** The format of I/O address for bit register is "I/O e.s/b", where, "e" is the slot number, "s" is the pixel number, and "b" is the bit number. If the address in PLC is O0 0.0/11, then the address in PT should be set to "O0 0.11"; and if the address in PLC is O0 0.1/8, then the address in PT should be set to "O0 1.8". When AB with the different CPU types uses the I/O modules, the addresses of I point and O point in PT are arranged consecutively. Take Micrologix1400 with output module 1762-OW16 as example, the address corresponding to O0 1.0/3 in PT is O0 6.3.

- 2** When the address is less than three digits, it should be filled with 0 to be three digits.  
Example: When 113 refer to File number 113 and 10.12 refers to Address 10.12, specify to 113010.12

## AB CompactLogix/ControlLogix Series (DF1) Driver

Device	Bit Address	Word Address	Format	Note
Integer data file bit level	N_BOOL000000.00~254254.15	-----	FFFDDD.DD	
Bit data file	B_BOOL000000~254991	-----	FFFDDD	
Floating point data file	-----	REAL000000~254254	FFFDDD	
Integer data file	-----	INT000000~254254	FFFDDD	

**Note 1** Take N\_ BOOL 112087.12 as example, the first three number 112 is the File Number, and 087.12 is the Variable No. Address. The blanks before the Variable No. Address less than three digits should be filled with 0.

**2** The File Number can be customized by the user.

**3** INT000000~254254 indicates that the range of the File Number is 0 to 254 (the first 3 digits), and the Address Range of the variable is 0 to 254 (the last 3 digits). If 001255 is input, a dialog box "over read address" will pop up, requesting the user to input again.

## AB MicroLogix Series Ethernet (TCP Slave) Driver

Device	Bit Address	Word Address	Format	Note
Internal Auxiliary Nodes	B3: 0.0~255.15	-----	DDD.DD	
Internal Auxiliary Nodes	B10: 0.0~255.15	-----	DDD.DD	
Internal Auxiliary Nodes	B11: 0.0~255.15	-----	DDD.DD	
Internal Auxiliary Nodes	B12: 0.0~255.15	-----	DDD.DD	
Internal Auxiliary Nodes	B13: 0.0~255.15	-----	DDD.DD	
Internal Auxiliary Nodes	Bf:n : 0.0~255255.15	-----	FFFDDD.DD	*1
External Output Nodes	O0: 0.0~255.15	-----	DDD.DD	
External Input Nodes	I1: 0.0~255.15	-----	DDD.DD	
Actual Value Registers for Counter	-----	C5PV: 0~255	DDD	
Setting Value Register for Counter	-----	C5SV: 0~255	DDD	
Floating-point Data Registers	-----	F8: 0~255	DDD	
Floating-point Data Registers	-----	Ff:n : 0~255255	FFFDDD	*1
Input Data File	-----	IW1: 0~255	DDD	
Data Registers	-----	N7: 0~255	DDD	
Data Registers	-----	N10: 0~255	DDD	
Data Registers	-----	N11: 0~255	DDD	
Data Registers	-----	N12: 0~255	DDD	
Data Registers	-----	N13: 0~255	DDD	
Data Registers	-----	N14: 0~255	DDD	
Data Registers	-----	N15: 0~255	DDD	
Data Registers	-----	Nf:n :0~255255	FFFDDD	*1
Output Data File	-----	OW1: 0~255	DDD	
Actual Value Registers for Timer	-----	T4PV: 0~255	DDD	
Setting Value Registers for Timer	-----	T4SV: 0~255	DDD	

\*1 When the address is less than three digits, it should be filled with 0 to be three digits.

Example: When 113 refers to File number 113 and 10.12 refers to Address 10.12, specify to 113010.12.

## 9-5 Cable Fabrication

### Serial Communication Cable

#### ● RS232 Communication Cable for MicroLogix

- Communication Cable (Cat.No.: 1761-CBL-PM02) manufactured by Rockwell Automation, Inc.

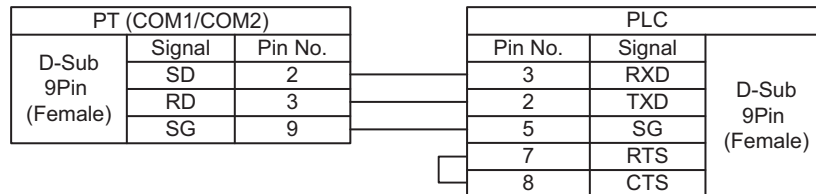

- ALC +Advanced Interface Converter (Cat.No.:1761-NTE-AIC) and RS232 Communication Cable

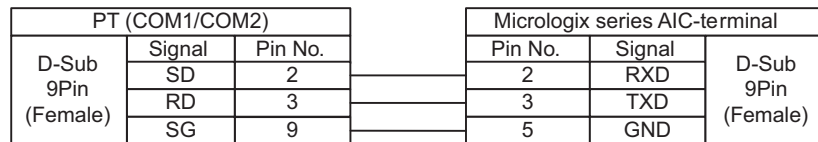

#### ● RS232 Communication Cable for SLC 5 / 03

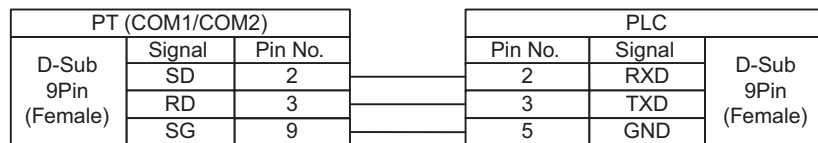

#### ● RS232 Communication Cable for CompactLogix/ControlLogix

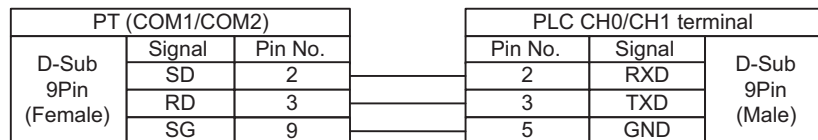

### Ethernet Communication Cable

Use Twisted Pair Cable to connect. Refer to *Ethernet communication specifications* in A-1-3 *Communication Specifications* in the *NB-series Programmable Terminals Setup Manual* (Cat. No. V107).

# 10

## Connecting to PLC of GE Fanuc Automation Inc.

This section describes the connection to PLC of GE Fanuc Automation Inc.

---

<b>10-1 Serial Port Communication</b> .....	<b>10-2</b>
<b>10-2 Serial Port Communication Parameters and Cable Fabrication</b> .....	<b>10-3</b>
<b>10-3 Serial Port Communication Parameter Setting</b> .....	<b>10-4</b>
<b>10-4 Supported Registers</b> .....	<b>10-7</b>
<b>10-5 Cable Fabrication</b> .....	<b>10-8</b>

## 10-1 Serial Port Communication

Series	CPU	Link Module	Driver
GE Fanuc Series 90-30	IC693CPU311	Serial Connector on Power Supply	GE Fanuc Series SNP (Break-free mode)*
	IC693CPU313		
	IC693CPU321		
	IC693CPU323		
	IC693CPU331		
	IC693CPU341		
	IC693CPU350		
	IC693CPU351		
	IC693CPU352		
	IC693CPU360		
	IC693CPU363		
	IC693CPU364		
	IC693CPU374		
	IC693CSE311		
	IC693CSE313		
IC693CSE323			
IC693CSE331			
IC693CSE340			
GE Fanuc Series 90-30	IC693CPU311	Connector on Power Supply	GE SNP-X
	IC693CPU313	IC693CMM311	
	IC693CPU321		
	IC693CPU323		
	IC693CPU331		
	IC693CPU340		
	IC693CPU341		
	IC693CPU350		
	IC693CPU360		
	IC693CPU364		
GE Fanuc Series 90-30	IC693CPU351	Connector on Power Supply	GE SNP-X
	IC693CPU352	Port1 on CPU unit	
	IC693CPU363	Port2 on CPU unit	
		IC693CMM311	
GE Fanuc Series 90-30	IC693CPU374	Port on Power Supply	GE SNP-X
		IC693CMM311	
VersaMax Series	CPU001/002/005	RS232 on port1	GE SNP-X
	CPUE05	RS422 on port2	
VersaMax Micro & Nano Series	IC200UAL004/005/006	RS232 on port1	GE SNP-X
	IC200UDD110/120/212	RS422 on port2	
	IC200UDR005/006/010		
	IC200UAA007		
	IC200UAR028		

\* Series 90 Product Supporting Break-free SNP Feature is as follows:

Product	Break-free SNP
Series 90-30 CPU350-364	Support on all serial communication ports starting with firmware release 9.00
Series 90-30 CPU311, 313, 323, 331, 341	Supported starting with firmware release 8.20

**Note** When you use the above-mentioned CPU(s) for communication, be sure to update it (them) to the specified version(s) in order to make communications with GE Fanuc Series SNP protocol.

## 10-2 Serial Port Communication Parameters and Cable Fabrication

Series	CPU	Link Module	COMM Type	Parameter	Cable
GE Fanuc Series 90-30	IC693CPU374	RS422 on the CPU unit	RS232	Refer to Section 10-3	Self-made cable required
			RS422		
		IC693CMM311	RS232		
			RS422		
VersaMax Series	CPU001/002/005	RS232 on port1	RS232		
		RS422 on port2	RS422		
VersaMax Micro & Nano Series	IC200UAL004/005/006 IC200UDD110/120/212 IC200UDR005/006/010 IC200UAA007 IC200UAR028	RS232 on port1	RS232		
		RS422on port2	RS422		

# 10-3 Serial Port Communication Parameter Setting

## PT Settings

Default communication parameters for GE Fanuc Series SNP Protocol: 19200 (Baud Rate), 8 (Data Bit), odd (Parity), 1 (Stop Bit), 1 (Station No.).

RS232 Communication

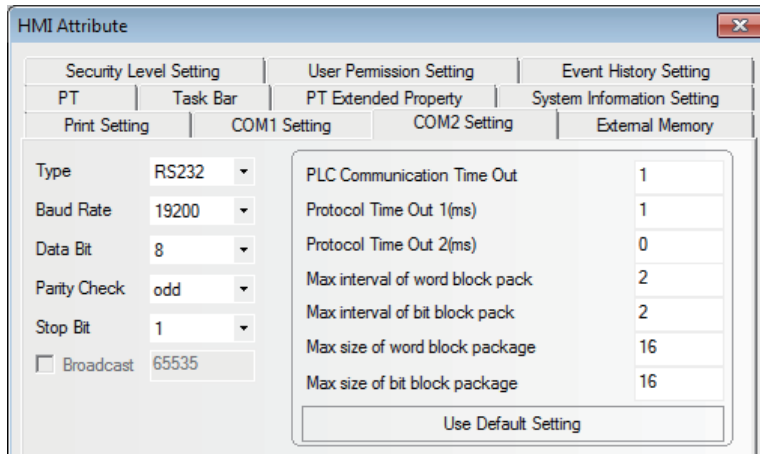

RS422 Communication

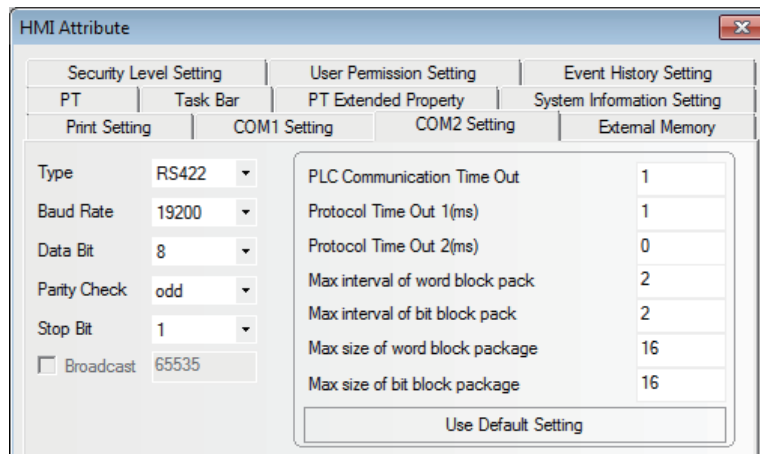



Default communication parameters for GE SNP-X Protocol: 19200 (Baud Rate), 8 (Data Bit), odd (Parity), 1 (Stop Bit), 1 (Station No.).

#### RS232 Communication

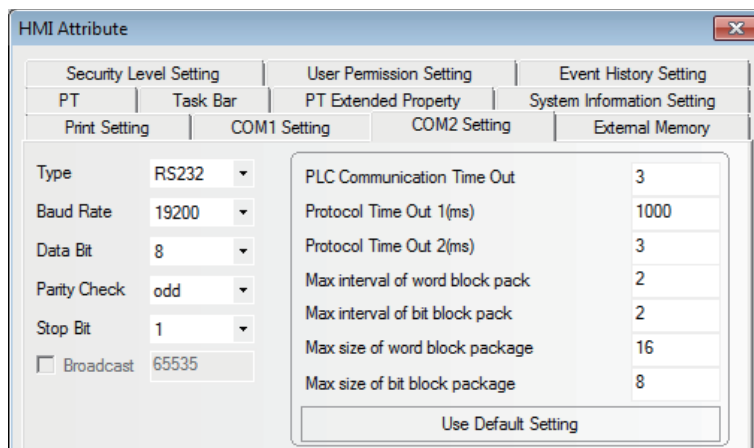

#### RS422 Communication

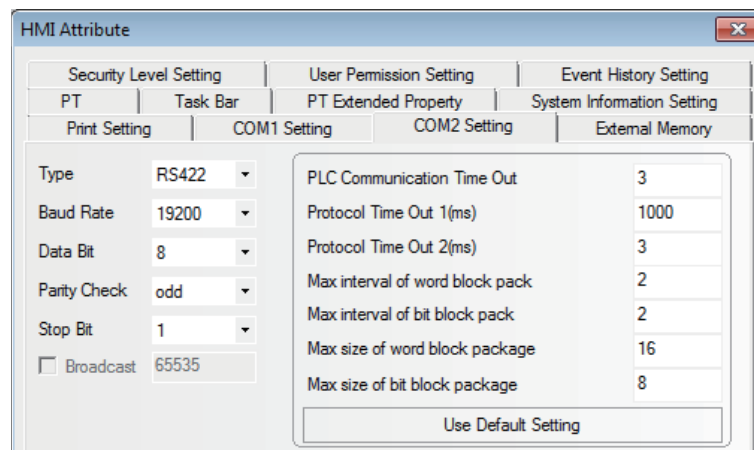

**Note** The maximum baud rate for the communication with serial port of GE Host is 19200 bps.

## PLC Settings

Take the settings of IC693CPU331 and IC693CMM311 as example:

Select the PLC and devices with the correct models in the Proficy Machine Edition window and you can see the default settings here. There is no need to change the settings unless for some special conditions. But please note the SNP settings. And it only needs to set the related parameters in the PT to be the same as that herein.

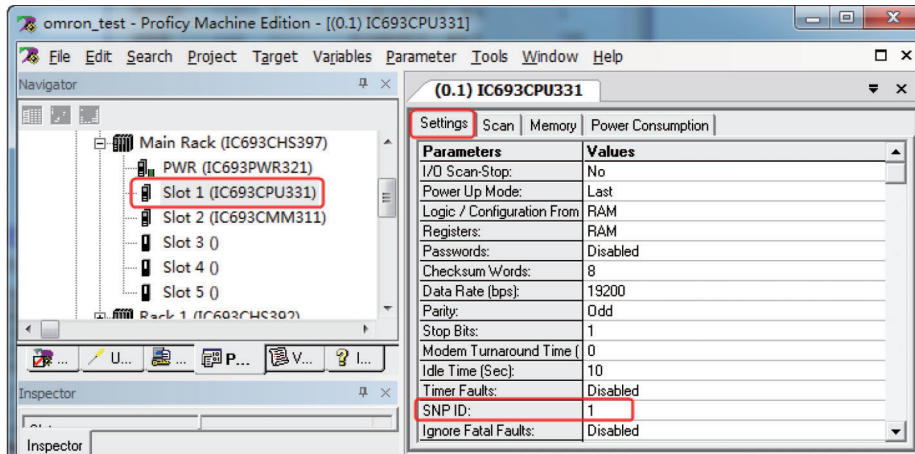

**Note** "SNP Only" should be selected during the configuration Mode setting.

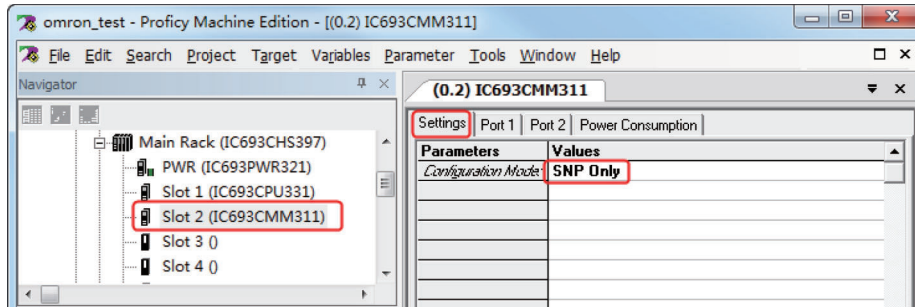

## 10-4 Supported Registers

Device	Bit Address	Word Address	Format	Notes
System	SC 01~32	-----	DD	
System	SB 01~32	-----	DD	
System	SA 01~32	-----	DD	
System	S 01~32	-----	DD	
Temporary	T 001~256	-----	DDD	
Internal	M 0001~4096	-----	DDDD	
Genius Global	G 0001~1280	-----	DDDD	
Output	Q 0001~2048	-----	DDDD	
Input	I 001~256	-----	DDD	
Analog Output	-----	AQ 001~512	DDD	
Analog Input	-----	AI 0001~2048	DDDD	
Register	-----	R 0001~9999	DDDD	

**Note** Address format description: D: decimal, O: octonary, H: hexadecimal

# 10-5 Cable Fabrication

- **RS232 Communication for GE Fanuc Series SNP**

Communicating with PT by directly using the communication cable provided by GE

- **RS232 Communication for VersaMax Series**

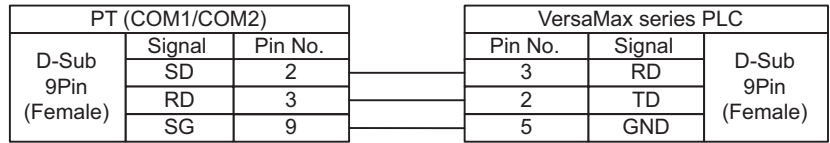

- **RS232 Communication for VersaMax Micro & Nano Series**

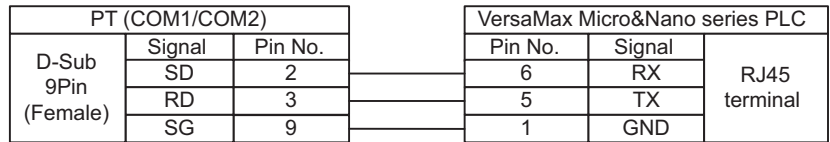

- **RS232 Communication Cable for Communication Module CMM311**

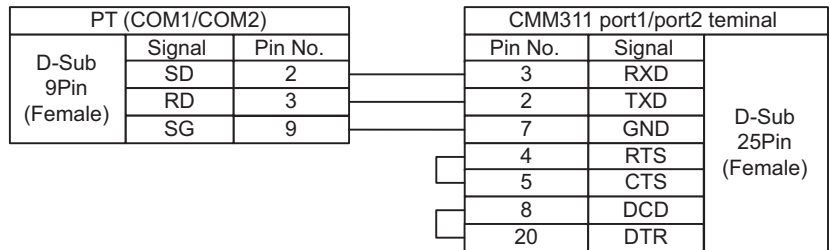

● RS422 Communication Cable for Communication Module CMM311

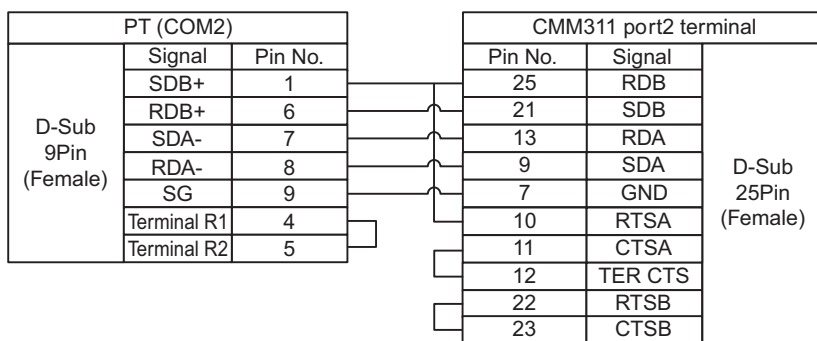

● RS422 Communication for 90-30/VersaMax

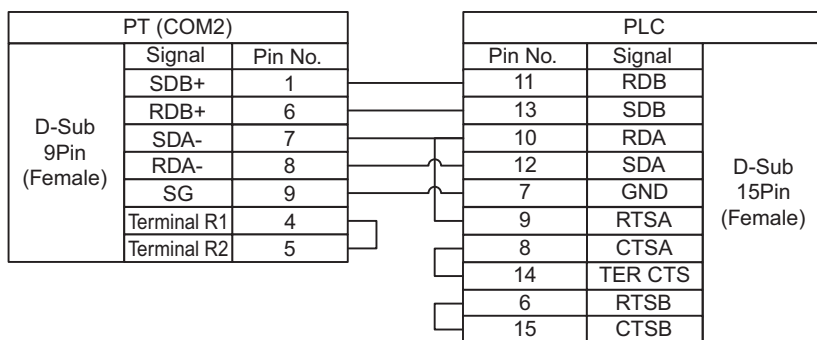



# 11

## Connecting to Keyence PLCs

This section describes methods to connect to Keyence PLCs.

---

<b>11-1 Serial Port and the Ethernet</b> .....	<b>11-2</b>
<b>11-2 Communication Setting and Cable Connection</b> .....	<b>11-3</b>
<b>11-3 Communication Setting</b> .....	<b>11-4</b>
11-3-1 When Using Keyence KV-3000 Communication Protocol .....	11-4
11-3-2 When Using Keyence KV-5000 EtherNetSlave Communication Protocol .....	11-5
<b>11-4 Supported Registers</b> .....	<b>11-7</b>
<b>11-5 Cable Connection</b> .....	<b>11-8</b>

## 11-1 Serial Port and the Ethernet

---

Series	CPU	Link Module	Driver
KV-3000	KV-3000 CPU	RS232 Port on CPU Unit	KeyenceKV-3000
KV-5000	KV-5000 CPU	Ethernet Port on CPU Unit	KeyenceKV-5000 EtherNetSlave

\* This Protocol supports Multiple Station No.



## 11-2 Communication Setting and Cable Connection

Series	CPU	Link Module	Communication Type	Set Value	Cable
KV-3000	KV-3000 CPU	RS232 Port on CPU Unit	RS232	Refer to <i>11-3 Communication Setting</i>	Self-made connecting cable required.
KV-5000	KV-5000 CPU	Ethernet Port on CPU Unit	-	Refer to <i>11-3 Communication Setting</i>	Network cable

## 11-3 Communication Setting

### 11-3-1 When Using Keyence KV-3000 Communication Protocol

#### PT Settings

PT default communication parameters: 9600bps (Baud Rate), 8 (Data Bit), even (Parity Check) and 1 (Stop Bit)

As showed in the right of dialog box as below, PLC Communication Time Out, Max interval of word block pack, Max interval of bit block pack, Max word block package are varied with PLC protocol. Generally, the default values are selected.

RS232 Communication

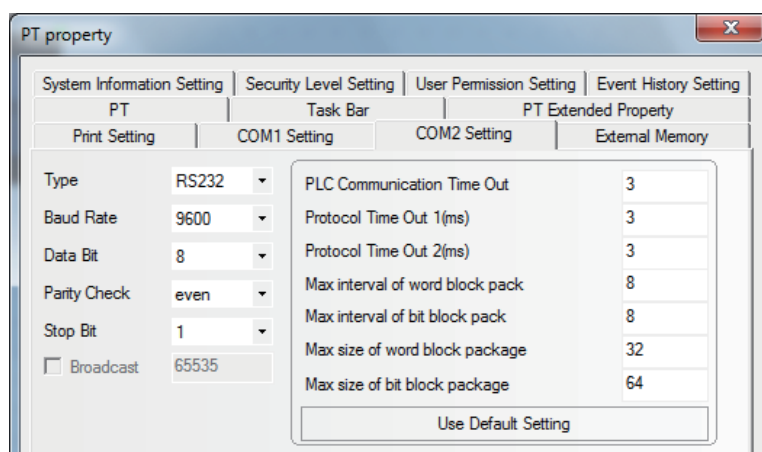

**Note** The Baud Rate supports 9600, 19200, 38400, 57600 and 115200.

#### PLC Settings

When Keyence KV-3000 Communication Protocol is used, the setting of PLC is not required.

### 11-3-2 When Using Keyence KV-5000 EtherNetSlave Communication Protocol

#### PT Setting

The PT Network Setting is shown as follows.

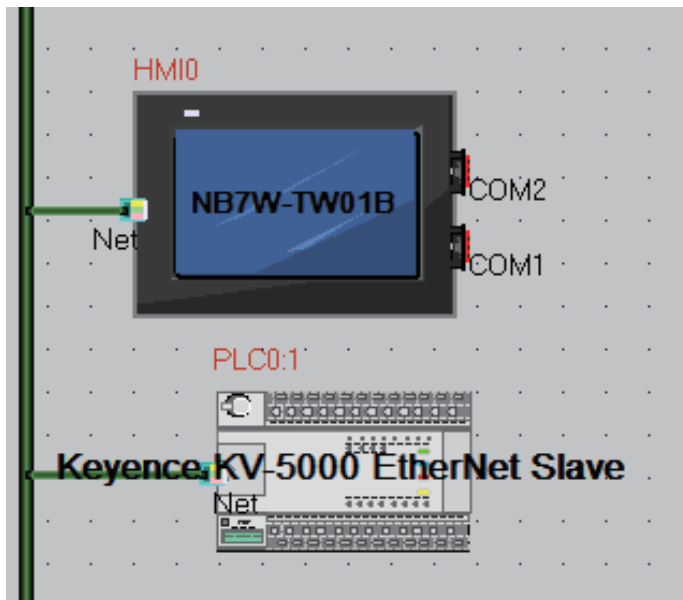

Communication Setting

Device	IP address	Port No.	Protocol	Master/Sla...	Station n...	Virtual PLC...
HMI0	192.168.250.1	2008	Keyence K...	M		
PLC0	192.168.250.2	8501	Keyence K...	S	1	

Buttons: Add, Delete, Delete All, Modify, OK

## PLC Setting

---

PLC Setting when using Keyence KV-5000 EtherNetSlave Protocol is shown as below.

**1** Double-click the [Ethernet] - [KV-5000] under [Unit Configuration] in KV-STUDIO Software.

**2** Open the [Unit Editor] dialog box.

Set the IP address and Port Number (upper link) to the same parameters as the PT setting.

## 11-4 Supported Registers

## KV-3000

Device	Bit Address	Word Address	Format	Notes
Input, Output, Internal Relay	R0-999.15	-----	DDD.DD	
Internal auxiliary Relay	MR0-999.15	-----	DDD.DD	
Control Relay	CR0-39.15	-----	DD.DD	
Latch Relay	LR0-999.15	-----	DDD.DD	
Data Memory	-----	DM0-65534	DDDDD	
Extended Data Memory	-----	EM0-65534	DDDDD	
Temporary Data Memory	-----	TM0-511	DDD	
Control Memory	-----	CM0-5999	DDDD	
File Register	-----	FM0-32767	DDDDD	

## KV-5000

Device	Bit Address	Word Address	Format	Notes
Input, Output, Internal Relay	R0-999.15	-----	DDD.DD	
Internal auxiliary Relay	MR0-999.15	-----	DDD.DD	
Control Relay	CR0-39.15	-----	DD.DD	
Latch Relay	LR0-999.15	-----	DDD.DD	
Data Memory	-----	DM0-65534	DDDDD	
Extended Data Memory	-----	EM0-65534	DDDDD	
Temporary Data Memory	-----	TM0-511	DDD	
Control Memory	-----	CM0-5999	DDDD	
File Register	-----	FM0-32767	DDDDD	

## 11-5 Cable Connection

### KV-3000 Series RS232 Communication Cable

- RS-232 Communication Cable

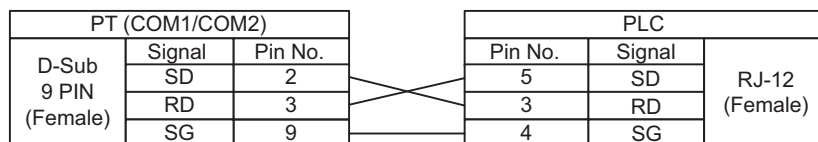

### KV-5000 Series Ethernet Communication Cable

Use Twisted Pair Cable to connect. Refer to *Ethernet communication specifications* in *A-1-3 Communication Specifications* in the *NB-series Programmable Terminals Setup Manual* (Cat. No. V107).

# 12

## Connecting to OMRON Safety Controller

This section describes the method to connect to OMRON Safety Controller.

---

<b>12-1 Serial Port</b> .....	<b>12-2</b>
<b>12-2 Communication Parameters and Cable Fabrication</b> .....	<b>12-3</b>
<b>12-3 Communication Parameter Setting</b> .....	<b>12-4</b>
12-3-1 When using OMRON G9SP Communication Protocol .....	12-4
<b>12-4 Supported Registers</b> .....	<b>12-6</b>
<b>12-5 Cable Connection</b> .....	<b>12-7</b>

## 12-1 Serial Port

---

Series	CPU	Destination	Driver
G9SP	G9SP-N10S G9SP-N10D G9SP-N20S	RS-232C Connector of Option Board mounted to the Safety Controller*	OMRON G9SP

\* Model CP1W-CIF01 is needed.



## 12-2 Communication Parameters and Cable Fabrication

Series	CPU	Destination	Communication Type	Set Value	Cable
G9SP	G9SP	RS-232C Connector of Option Board mounted on the Safety Controller	RS232	Refer to 12-3 <i>Communication Parameter Setting</i>	XW2Z-200T 2m XW2Z-500T 5m

## 12-3 Communication Parameter Setting

### 12-3-1 When using OMRON G9SP Communication Protocol

#### PT Settings

PT default communication parameters: 9600bps (Baud Rate), 8 (Data Bit), even number (Parity Check) and 1 (Stop Bit)

As showed in the right of dialog box as follow, the default values are generally selected to PLC Communication Time Out, Max interval of word block package, Max interval of bit block pack, and Max size of word block package.

RS232 Communication

The screenshot shows the 'HMI Attribute' dialog box with the following settings:

Security Levels Setting		User Permissions Setting		Historical Events Storage	
HMI		Task Bar		HMI Extended Attributes	
Print Setting		COM1 Setting		COM2 Setting	
				Extended Memory	
Type	RS232	PLC Communication Time Out	3		
Baud Rate	9600	Protocol Time Out 1 (ms)	3		
Data Bit	8	Protocol Time Out 2(ms)	3		
Parity Check	even	Max interval of word block pack	2		
Stop Bit	1	Max interval of bit block pack	8		
<input type="checkbox"/> Broadcast	65535	Max word block package size	16		
		Max bit block package size	64		
Use Default Setting					

**Note** G9SP Serial Communication Protocol only supports communication speed of 9600bps.

## PLC Settings

When OMRON G9SP Communication Protocol is used, the setting of PLC is not required.



### Precautions for Correct Use

For the specification of G9SP protocol, write occurs when the NB series startup.

Therefore, from the NB series startup until the value is set to the WD area, initial value 0 is written to "Optional Communications Reception Data" of G9SP.

When "Optional Communications Reception Data" of G9SP is used in the program of G9SP, follow the indications to avoid accidental writing the initial value 0 from the NB series.

- When the NB series or power supply is restarted during the G9SP operation, make sure that no influences to the G9SP to perform it.
- After set the initial value to the WD area with the Macro and arrange the components which can execute the Macro when timer component or others startup in startup screen, set the value of the WD area before write occurs.

```

24 int MacroEntry()
25 {
26     W = 0x88888888;
27     return 0;
28 }

```

Storage F...	Name	PLC No.	Area	Address	Word...	R/W	Array	Array length
unsigned int	W	0	WD	0	2	Write	No	

Also be aware of the initial value 0 which is written from the NB series even at G9SP to design the program.

## 12-4 Supported Registers

### Transmission Data (G9SP Series → PT)

Device	Bit Address (format DD)	Word Address (format DD)	Notes
Optional Communications Transmission Data	CTD 0-31	----	
Safety Input Terminal Data Flags	SID 0-47	----	
Safety Output Terminal Data Flags	SOD 0-31	----	
Safety Input Terminal Status Flags	SIS 0-47	----	
Safety Output Terminal Status Flags	SOS 0-31	----	
Safety Input Terminal Error Causes	----	SIE 0-47	Nibble device
Safety Output Terminal Error Causes	----	SOE 0-31	Nibble device
Reserved	----	RES1 0-1	Byte device
Unit Status and Echo-back	USE 0-15	----	
Configuration ID	----	CID 0-0	
Unit Conduction Time	----	UCT 0-0	Double word device
Reserved	----	RES2 0-19	Byte device
Present Error Information	----	PEI 0-11	Byte device
Error Log Count	----	ELC 0-0	Byte device
Operation Log Count	----	OLC 0-0	Byte device
Error Log	----	EL 0-9	Double word device
Operation Log	----	OL 0-9	Double word device

### Reception Data (PT → G9SP Series)

Device	Bit Address (format DD)	Word Address (format DD)	Notes
Optional Communication Reception Data	WD_Bit 0-31	WD 0-1	



#### Additional Information

In the case of a byte device or a nibble device, insufficient byte to the Word length are to be filled with 0.

Example: In the communication data, when the sent data is 0x12345678 and upper bytes are read as the byte device, all the bytes are displayed as 0x00001234.

## 12-5 Cable Connection

---

- **RS-232 Communication Cable**

Use either of cables recommended for the communication cable.

XW2Z-200T (cable length 2m) manufactured by OMRON

XW2Z-500T (cable length 5m) manufactured by OMRON



# Revision History

A manual revision code appears as a suffix to the catalog number on the front cover of the manual.

Cat. No. V108-E1-□

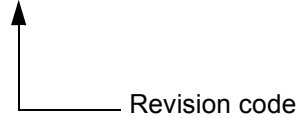

Revision code	Date	Revised content
01	October 2011	Original production
02	April 2012	Adding descriptions of Modbus network interface communication and Modbus protocol.
03	August 2012	Adding descriptions of connecting to PLCs manufactured by Allen-Bradley and GE Fanuc Automation INC.
04	December 2012	Correction related to the backlight lamp and rubber packing maintenance in Precautions for Safe Use.
05	December 2012	<ul style="list-style-type: none"> <li>• Adding descriptions of the power supply and wire connection in Precautions for Safe Use.</li> <li>• Adding descriptions of the serial port COM.</li> <li>• Adding descriptions of E5CC/E5EC and 3G3MX2 connection using Modbus protocol.</li> </ul>
06	April 2013	Changes and corrections
07	August 2013	Adding descriptions of support models
08	November 2013	Changes and corrections
09	February 2014	Adding descriptions of support models
10	July 2014	Adding descriptions of support models
11	October 2014	Adding descriptions of support models
12	April 2016	Changes and corrections
13	October 2016	Changes and corrections
14	March 2017	Changes and corrections
15	July 2017	Adding descriptions of support models
16	December 2017	Changes and corrections
17	April 2018	Changes and corrections
18	November 2019	Changes and corrections
19	October 2020	Changes and corrections
20	August 2022	Adding warnings of Safety Precautions
21	March 2023	Adding descriptions of NB3Q/NB5Q/NB7W/NB10W-TW□□B(-V1).
22	September 2023	Updating communication list for NB3Q/NB5Q/NB7W/NB10W-TW□□B-V1.







## **OMRON Corporation Industrial Automation Company**

**Kyoto, JAPAN**

**Contact : [www.ia.omron.com](http://www.ia.omron.com)**

### ***Regional Headquarters***

#### **OMRON EUROPE B.V.**

Wegalaan 67-69, 2132 JD Hoofddorp  
The Netherlands  
Tel: (31) 2356-81-300 Fax: (31) 2356-81-388

#### **OMRON ASIA PACIFIC PTE. LTD.**

438B Alexandra Road, #08-01/02 Alexandra  
Technopark, Singapore 119968  
Tel: (65) 6835-3011 Fax: (65) 6835-2711

#### **OMRON ELECTRONICS LLC**

2895 Greenspoint Parkway, Suite 200  
Hoffman Estates, IL 60169 U.S.A.  
Tel: (1) 847-843-7900 Fax: (1) 847-843-7787

#### **OMRON (CHINA) CO., LTD.**

Room 2211, Bank of China Tower,  
200 Yin Cheng Zhong Road,  
PuDong New Area, Shanghai, 200120, China  
Tel: (86) 21-5037-2222 Fax: (86) 21-5037-2200

**Authorized Distributor:**

©OMRON Corporation 2011-2023 All Rights Reserved.  
In the interest of product improvement,  
specifications are subject to change without notice.

**Cat. No. V108-E1-22** 0923