

## Fixed Mount 2D Code Reader FQ-CR2

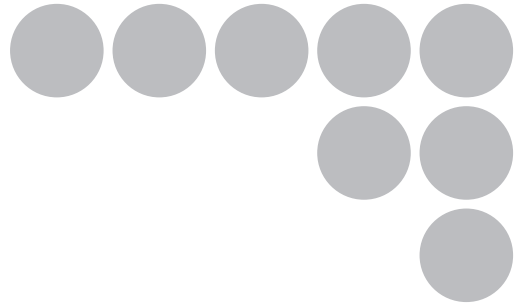

## User's Manual



# Introduction

---

Thank you for purchasing the FQ-CR2.

This manual provides information regarding functions, performance and operating methods that are required for using the FQ-CR2.

When using the FQ-CR2, be sure to observe the following:

- The FQ-CR2 must be operated by personnel knowledgeable in electrical engineering.
- To ensure correct use, please read this manual thoroughly to deepen your understanding of the product.
- Please keep this manual in a safe place so that it can be referred to whenever necessary.

# User's Manual

APPLICATION CONSIDERATIONS  
(Please Read)

Introduction

1

Installation and Connections

2

Taking Images

3

Setting Up Inspections

4

Testing and Saving Settings

5

Operation

6

Convenient Functions

7

Communications with External Devices

8

Troubleshooting

9

Appendices

10

## **READ AND UNDERSTAND THIS DOCUMENT**

Please read and understand this document before using the products. Please consult your OMRON representative if you have any questions or comments.

## **WARRANTY**

OMRON's exclusive warranty is that the products are free from defects in materials and workmanship for a period of one year (or other period if specified) from date of sale by OMRON.

OMRON MAKES NO WARRANTY OR REPRESENTATION, EXPRESS OR IMPLIED, REGARDING NON-INFRINGEMENT, MERCHANTABILITY, OR FITNESS FOR PARTICULAR PURPOSE OF THE PRODUCTS. ANY BUYER OR USER ACKNOWLEDGES THAT THE BUYER OR USER ALONE HAS DETERMINED THAT THE PRODUCTS WILL SUITABLY MEET THE REQUIREMENTS OF THEIR INTENDED USE. OMRON DISCLAIMS ALL OTHER WARRANTIES, EXPRESS OR IMPLIED.

## **LIMITATIONS OF LIABILITY**

OMRON SHALL NOT BE RESPONSIBLE FOR SPECIAL, INDIRECT, OR CONSEQUENTIAL DAMAGES, LOSS OF PROFITS OR COMMERCIAL LOSS IN ANY WAY CONNECTED WITH THE PRODUCTS, WHETHER SUCH CLAIM IS BASED ON CONTRACT, WARRANTY, NEGLIGENCE, OR STRICT LIABILITY.

In no event shall responsibility of OMRON for any act exceed the individual price of the product on which liability is asserted.

IN NO EVENT SHALL OMRON BE RESPONSIBLE FOR WARRANTY, REPAIR, OR OTHER CLAIMS REGARDING THE PRODUCTS UNLESS OMRON'S ANALYSIS CONFIRMS THAT THE PRODUCTS WERE PROPERLY HANDLED, STORED, INSTALLED, AND MAINTAINED AND NOT SUBJECT TO CONTAMINATION, ABUSE, MISUSE, OR INAPPROPRIATE MODIFICATION OR REPAIR.

## **SUITABILITY FOR USE**

THE PRODUCTS CONTAINED IN THIS DOCUMENT ARE NOT SAFETY RATED. THEY ARE NOT DESIGNED OR RATED FOR ENSURING SAFETY OF PERSONS, AND SHOULD NOT BE RELIED UPON AS A SAFETY COMPONENT OR PROTECTIVE DEVICE FOR SUCH PURPOSES.

Please refer to separate catalogs for OMRON's safety rated products.

OMRON shall not be responsible for conformity with any standards, codes, or regulations that apply to the combination of products in the customer's application or use of the product.

At the customer's request, OMRON will provide applicable third party certification documents identifying ratings and limitations of use that apply to the products. This information by itself is not sufficient for a complete determination of the suitability of the products in combination with the end product, machine, system, or other application or use.

The following are some examples of applications for which particular attention must be given. This is not intended to be an exhaustive list of all possible uses of the products, nor is it intended to imply that the uses listed may be suitable for the products:

- Outdoor use, uses involving potential chemical contamination or electrical interference, or conditions or uses not described in this document.

- Nuclear energy control systems, combustion systems, railroad systems, aviation systems, medical equipment, amusement machines, vehicles, safety equipment, and installations subject to separate industry or government regulations.
- Systems, machines, and equipment that could present a risk to life or property.

Please know and observe all prohibitions of use applicable to the products.

NEVER USE THE PRODUCTS FOR AN APPLICATION INVOLVING SERIOUS RISK TO LIFE OR PROPERTY WITHOUT ENSURING THAT THE SYSTEM AS A WHOLE HAS BEEN DESIGNED TO ADDRESS THE RISKS, AND THAT THE OMRON PRODUCT IS PROPERLY RATED AND INSTALLED FOR THE INTENDED USE WITHIN THE OVERALL EQUIPMENT OR SYSTEM.

## **PERFORMANCE DATA**

Performance data given in this document is provided as a guide for the user in determining suitability and does not constitute a warranty. It may represent the result of OMRON's test conditions, and the users must correlate it to actual application requirements. Actual performance is subject to the OMRON Warranty and Limitations of Liability.

## **CHANGE IN SPECIFICATIONS**

Product specifications and accessories may be changed at any time based on improvements and other reasons.

It is our practice to change model numbers when published ratings or features are changed, or when significant construction changes are made. However, some specifications of the product may be changed without any notice. When in doubt, special model numbers may be assigned to fix or establish key specifications for your application on your request. Please consult with your OMRON representative at any time to confirm actual specifications of purchased products.

## **DIMENSIONS AND WEIGHTS**

Dimensions and weights are nominal and are not to be used for manufacturing purposes, even when tolerances are shown.

## **ERRORS AND OMISSIONS**

The information in this document has been carefully checked and is believed to be accurate; however, no responsibility is assumed for clerical, typographical, or proofreading errors, or omissions.

## **PROGRAMMABLE PRODUCTS**

OMRON shall not be responsible for the user's programming of a programmable product, or any consequence thereof.

## **COPYRIGHT AND COPY PERMISSION**

This document shall not be copied for sales or promotions without permission.

This document is protected by copyright and is intended solely for use in conjunction with the product. Please notify us before copying or reproducing this document in any manner, for any other purpose. If copying or transmitting this document to another, please copy or transmit it in its entirety.

## Meanings of Signal Words

The following signal words are used in this manual.



Indicates a potentially hazardous situation which, if not avoided, will result in minor or moderate injury, or may result in serious injury or death. Additionally there may be significant property damage.

## Meanings of Alert Symbols

The following alert symbols are used in this manual

	Indicates general prohibitions for which there is no specific symbol.
	Indicates the possibility of laser radiation.
	Indicates the possibility of explosion under specific conditions.
	Indicates prohibition when there is a risk of minor injury from electrical shock or other source if the product is disassembled.



This product is not designed or rated for ensuring safety of persons.  
Do not use it for such purposes.



The Sensor emits visible light, which may adversely affect the eyes in rare instances.  
Do not look directly into the light emitted from the Sensor. When the subject is a specular reflective object, protect your eyes from reflected light.



A lithium ion battery is built into the Touch Finder and may occasionally combust, explode, or burn if not treated properly.  
Dispose of the Touch Finder as industrial waste, and never disassemble, apply pressure that would deform, heat to 100 °C or higher, or incinerate the Touch Finder.



High-voltage parts inside; danger of electrical shock. Do not open the product cover.



## Precautions for Safe Use

The following points are important to ensure safety, so make sure that they are strictly observed.

### 1. Installation Environment

- Do not use the product in environments where it can be exposed to inflammable/explosive gas.
- To secure the safety of operation and maintenance, do not install the product close to high-voltage devices and power devices.
- Install the product in such a way that its ventilation holes are not blocked.
- Tighten mounting screws at the torque specified in this manual.

### 2. Power Supply and Wiring

- The power supply voltage must be within the rated range (24 VDC  $\pm$ 10%), and an AC voltage must not be used.
- Reverse connection of the power supply is not allowed. Do not short the load of the open collector output.
- The load must be within the rated range.
- High-voltage lines and power lines must be wired separately from this product. Wiring them together or placing them in the same duct may cause induction, resulting in malfunction or damage.
- Use the products within the power supply voltages specified in this manual.
- Use the specified size of crimp terminals to wire connections. Do not connect wires that have been simply twisted together directly to the power supply or terminal block.
- Use a DC power supply with safety measures against high voltages (safety extra low-voltage circuit).
- Use independent power sources for the products. Do not use a shared power source.
- Tighten mounting screws at the torque specified in this manual.
- Always turn OFF the power supply before connecting or disconnecting cables or the power supply wiring.

### 3. Battery

- Do not short the positive and negative terminals of the Battery.
- Do not use the Touch Finder in an environment that exceeds the operating temperature range of the Battery. If the Touch Finder is used at temperatures that exceed the operating temperature range, the protective device may activate and prevent charging.
- Do not connect the Battery directly to a power supply or car cigarette lighter socket.
- Do not use the Touch Finder with any other type of battery.
- Turn OFF the power supply immediately if the Battery leaks or produces an odor. Electrolyte leaked from the Battery may ignite, possibly causing smoke, rupture, or fire.
- If during usage, charging, or storage, the Battery produces an odor, heats, becomes discolored, becomes misshapen, or exhibits any other unusual conditions, remove it and do not use it. Continuing to use such a Battery may result in the Battery heating, smoking, rupturing, or igniting.
- If the Touch Finder (FQ-D31) will be installed permanently or semi-permanently, remove the Battery (FQ-BAT1). If the rated temperature is exceeded with the Battery inserted, the protective circuit may activate and stop the Touch Finder.

### 4. AC Adapter

- Use an AC cable that is suitable for the power supply and power voltage you are using.
- Do not touch the power plug with a wet hand. Doing so may result in electrical shock.
- If you notice an abnormal condition, such as smoke, abnormal heating of the outer surface, or a strange odor, immediately stop using the AC Adapter, turn OFF the power, and remove the power plug from the outlet.  
Consult your dealer, as it is dangerous to attempt to repair the AC Adapter yourself.
- If the AC Adapter is dropped or damaged, turn OFF the power, remove the power plug from the outlet, and contact your dealer. There is a risk of fire if you continue using the AC Adapter.

## 5. EMC Standard

- EN61326-1
- Electromagnetic environment : Industrial electromagnetic environment (EN/IEC 61326-1 Table 2)
- The following condition is applied to the immunity test of this product  
: If the level of disturbance of the video is such that characters on the monitor are readable, the test is a pass.

## 6. Other

- Do not use this product in safety circuits associated with nuclear power and human life.
- Do not disassemble, repair, modify, deform by pressure, or incinerate this product.
- Dispose of this product as industrial waste.
- Connect the special products (Sensor, Touch Finder, Cables). The product might break down or malfunction if you use a part not included in the special products.
- If you notice an abnormal condition, such as a strange odor, extreme heating of any product, or smoke, immediately stop using the product, turn OFF the power, and consult your dealer.
- The Sensor surfaces become hot during use. Do not touch them.
- Do not drop or subject the products to shock.
- Use the special Sensor (FQ-CR2), Touch Finder (FQ-D), Cables (FQ-WN and FQ-WD), Battery (FQ-BAT1), and AC Adapter (FQ-AC). Using other than the specified products may cause fire, burning, malfunction or failure.
- If the product has a lock mechanism, always make sure it is locked before using the product.



## Precautions for Correct Use

Observe the following precautions to prevent failure to operate, malfunctions, or undesirable effects on product performance.

### 1. Installation Site

Do not install this product in locations subjected to the following conditions:

- Ambient temperature outside the rating
- Rapid temperature fluctuations (causing condensation)
- Relative humidity outside the range of 35 to 85%
- Direct vibration or shock
- Strong ambient light (such as other laser beams, light from arc-welding machines, or ultraviolet light)
- Direct sunlight or near heaters
- Strong magnetic or electric field

Also, do not install this product in locations subjected to the following conditions to ensure its protective performance as described in the specifications:

- Presence of corrosive or flammable gases
- Presence of dust, salt, or iron particles
- Water, oil, or chemical fumes or spray, or mist atmospheres

### 2. Power Supply, Connection, and Wiring

- When using a commercially available switching regulator, make sure that the FG terminal is grounded.
- If surge currents are present in the power lines, connect surge absorbers that suit the operating environment.
- Before turning ON the power after the product is connected, make sure that the power supply voltage is correct, there are no incorrect connections (e.g. load short-circuit) and the load current is appropriate. Incorrect wiring may result in breakdown of the product.
- For cables, use only the special products specified in this manual.

 p.178, p.179

- Use only combinations of the Sensor and Touch Finder specified in this manual. Using other combinations may cause malfunction or damage.
- Do not turn the power OFF in the following instances. Doing so will damage data that is in the process of being saved.
  - While data is being saved in internal memory
  - While data is being saved on the SD card
- The LCD panel has been made using precision technology, and sometimes a few pixels are missing in the panel. This is due to the structure of the LCD panel, and is not a malfunction.
- Connector cover  
Always attach the covers of I/O cable connector and Ethernet cable connector. This prevents extraneous material from making malfunction of the Sensor.

### 3. Battery

- Do not use or charge the Battery with other than the specified products.
- Do not charge the Battery with other than the specified AC adapter.
- When using the Touch Finder, the battery cover screw must be tightened.

### 4. AC Adapter

- During maintenance and when not using the Touch Finder for an extended time, remove the power plug from the outlet.
- Do not bend the power cable past its natural bending radius.
- Do not use the AC Adapter with other than the specified products.
- If a voltage higher than 380 V is applied, there is a risk that the capacitor will be damaged, the pressure valve will open, and vaporized gas will be emitted. If there is a possibility that a voltage higher than 380 V will be applied, use a protective device.

## 5. Maintenance and Inspection

Do not use thinner, benzene, acetone or kerosene to clean the Sensor and Touch Finder. If large dust particles adhere to the Camera, use a blower brush (used to clean camera lenses) to blow them off. Do not use breath from your mouth to blow the dust off. To remove dust particles from the Camera, wipe gently with a soft cloth (for cleaning lenses) moistened with a small amount of alcohol. Do not use excessive force to wipe off dust particles. Scratches to the Camera might cause error.

### Editor's Note

#### ■ Meaning of Symbols

Menu items that are displayed on the Touch Finder LCD screen, and windows, dialog boxes and other GUI elements displayed on the PC are indicated enclosed by brackets "[ ]".

#### ■ Visual Aids

##### Important

Indicates points that are important to achieve the full product performance, such as operational precautions.

##### Note

Indicates application procedures.



Indicates pages where related information can be found.

# Table of Contents

## 1. Introduction

1-1 Fixed Mount 2D Code Reader FQ-CR2 .....	12
1-2 Measurement Process .....	13
1-3 Startup Display and Display Elements .....	14
1-4 Basic Operational Flow .....	16

## 2. Installation and Connections

2-1 System Configuration .....	18
2-2 Part Names and Functions .....	19
2-3 Installation .....	21
2-4 Wiring .....	26
2-5 Setting Up Ethernet .....	31

## 3. Taking Images

3-1 Selecting a Sensor for Configuration .....	34
3-2 Adjusting Image Quality .....	35
3-3 Adjusting the Object Position .....	41
3-4 Preventing Mutual Interference of Multiple Sensors .....	43
3-5 Setting How the Image is Processed After Scanning .....	44

## 4. Setting Up Inspections

4-1 Setup Procedure for Inspection Items .....	46
4-2 Configuring Inspection Items .....	47
4-3 Setting 2D Code Inspection Conditions .....	49

## 5. Testing and Saving Settings

5-1 Performing Test Measurements .....	54
5-2 Shortening the Measurement Takt Time .....	56
5-3 Checking a List of All Inspection Item Results .....	57
5-4 Saving Data to the Sensor .....	58

## 6. Operation

6-1 Starting Operation.....	60
6-2 Configuring the Run Mode Display .....	62
6-3 Checking the Trend of Measurement Results with Graphs .....	64
6-4 If Scanning Fails .....	67

## 7. Convenient Functions

7-1 Changing the Scene to Change the Line Process .....	70
7-2 Display Functions .....	72
7-3 Monitoring the Signal I/O Status .....	75
7-4 Logging Measurement Data and Image Data .....	76
7-5 Saving Sensor Settings .....	83
7-6 SD Card Operations .....	84
7-7 Convenient Functions for Operation.....	86
7-8 Convenient Functions for Setup .....	88
7-9 Functions Related to the System.....	89
7-10 Setting the Retry Function .....	91

## 8. Communications with External Devices

8-1 Controlling/Outputting in Parallel .....	96
8-2 Outputting/Controlling with Ethernet .....	118

## 9. Troubleshooting

9-1 Error Table.....	154
9-2 Basic Troubleshooting .....	156

## 10. Appendices

10-1 Menu Tables.....	158
10-2 External Reference Parameters .....	168
10-3 Specifications and Dimensions .....	170
10-4 Updating the Software .....	180
Index.....	182
Revision History .....	186

# Introduction

---

<b>1-1 Fixed Mount 2D Code Reader FQ-CR2 .....</b>	<b>12</b>
<b>1-2 Measurement Process .....</b>	<b>13</b>
<b>1-3 Startup Display and Display Elements .....</b>	<b>14</b>
<b>1-4 Basic Operational Flow .....</b>	<b>16</b>

# 1-1 Fixed Mount 2D Code Reader FQ-CR2

The FQ-CR2 is a fixed mount 2D code reader that is easy to use and has advanced scanning features. Once configured, they are used stand-alone for quality inspection of presence, position, and other product characteristics. To set up or monitor the sensors, either the touch screen based console 'Touch Finder' or a 'PC Tool' can be used.

Fixed Mount 2D Code Reader  
FQ-CR2

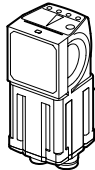

Includes the camera, lighting, measurement processor, and I/O functions. After the Sensor has been set up, it can be operated alone to perform measurements without the Touch Finder or PC Tool.

## Setup, Image Confirmation, and Logging Tools

Touch Finder

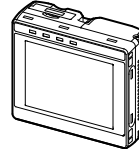

Used to check images and set the judgement parameters. It can also be used to save measurement results and check status during operation.

PC Tool



The same functions as those that are provided by the Touch Finder can be performed from a computer. The PC Tool is available free of charge.

# 1-2 Measurement Process

This section describes the basic flow of the measurement process.

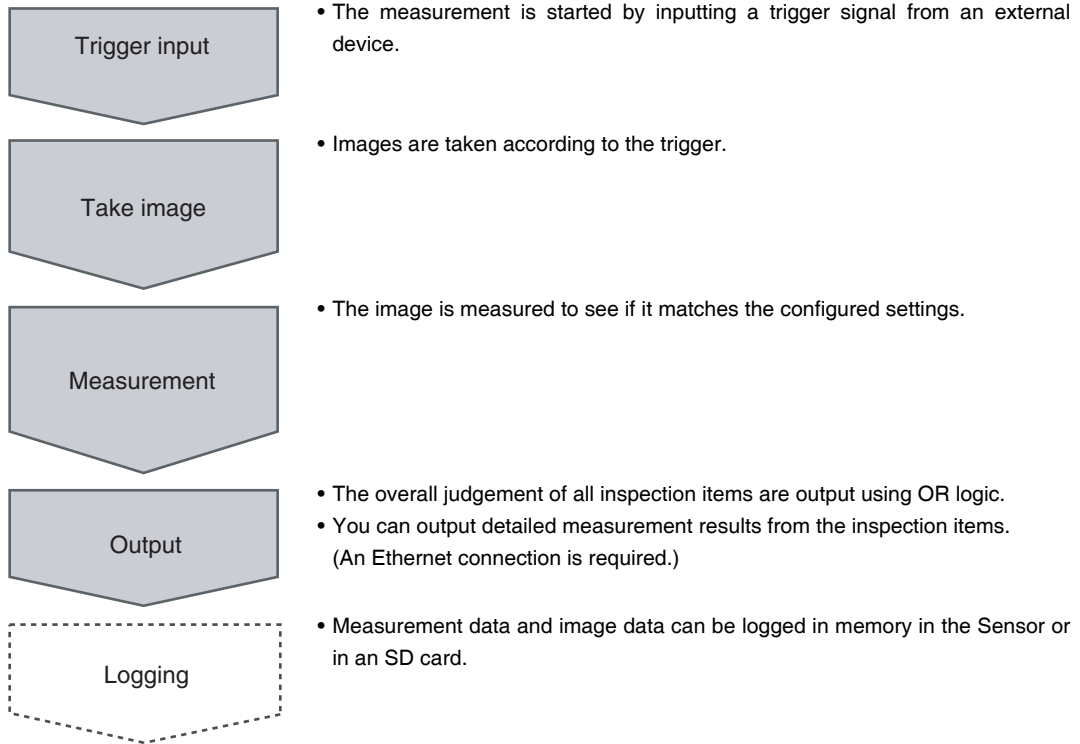

# 1-3 Startup Display and Display Elements

## Startup Display

- 1 The Sensor is automatically detected by the Touch Finder when power supply to the Sensor and Touch Finder is turned ON.**

The Auto Connect Display will appear if the Sensor cannot be detected. Check that cables are connected correctly to the Sensor and Touch Finder, and then press [Auto connect].

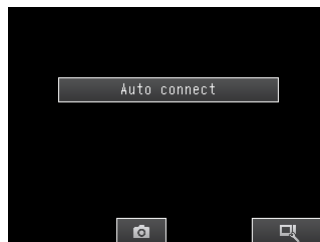

### Note

If the Sensor is still not detected after pressing [Auto Connect], refer to the following information.

 The Sensor cannot be detected: p. 156

- 2 When the Sensor is detected, the following display will appear.**



### Note

When the Touch Finder is started, IP addresses are automatically set for each Sensor. To allocate specific IP addresses, set the IP address of each Sensor and the Touch Finder.

 Setting Up Ethernet: p. 31



## Display Elements

This Sensor has a Setup Mode and a Run Mode.  
Refer to the following information for menu items.

 p. 158

### Setup Mode

In Setup Mode, you can set the image conditions, judgement parameters, and I/O settings for the Sensor.

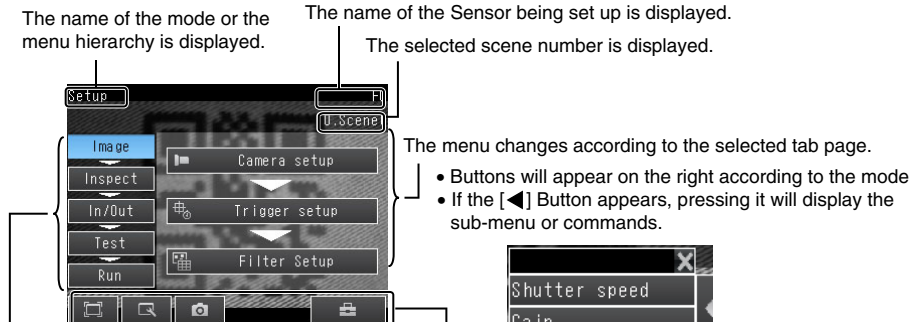

The name of the mode or the menu hierarchy is displayed.

The name of the Sensor being set up is displayed.

The selected scene number is displayed.







The menu changes according to the selected tab page.

- Buttons will appear on the right according to the mode.
- If the [◀] Button appears, pressing it will display the sub-menu or commands.

The setup flow is shown by these five tabs.

[Image]: Used to adjust the image.  
[Inspect]: Used to set the inspection items.  
[In/Out]: Used to set the I/O.  
[Test]: Used to test and adjust the set measurements.  
[Run]: Used to switch to Run Mode.

This button menu is always displayed.

-  Only-image Button: Used to select either displaying the camera image and messages, or only the camera image.
-  Display Button: Used to select the source of the image or to zoom the image.  
 Display Functions: p. 72
-  Capture Button: Used to capture the current screen to the SD card.  
 p. 87
-  Tool Button: Used to call functions, such as saving data or select scenes.

#### Note

The Display Button can be used to switch between the following images.

- Live: The live image is displayed.
- Freeze: The image that was taken last is displayed.
- Log: An image saved in internal memory is displayed.
- File: An image saved on an SD card is displayed.

### Run Mode

In Run Mode, measurements are performed, and measurement results are output.

 p. 59

# 1-4 Basic Operational Flow

The following flow shows the basic operation of FQ-CR2 Sensors.

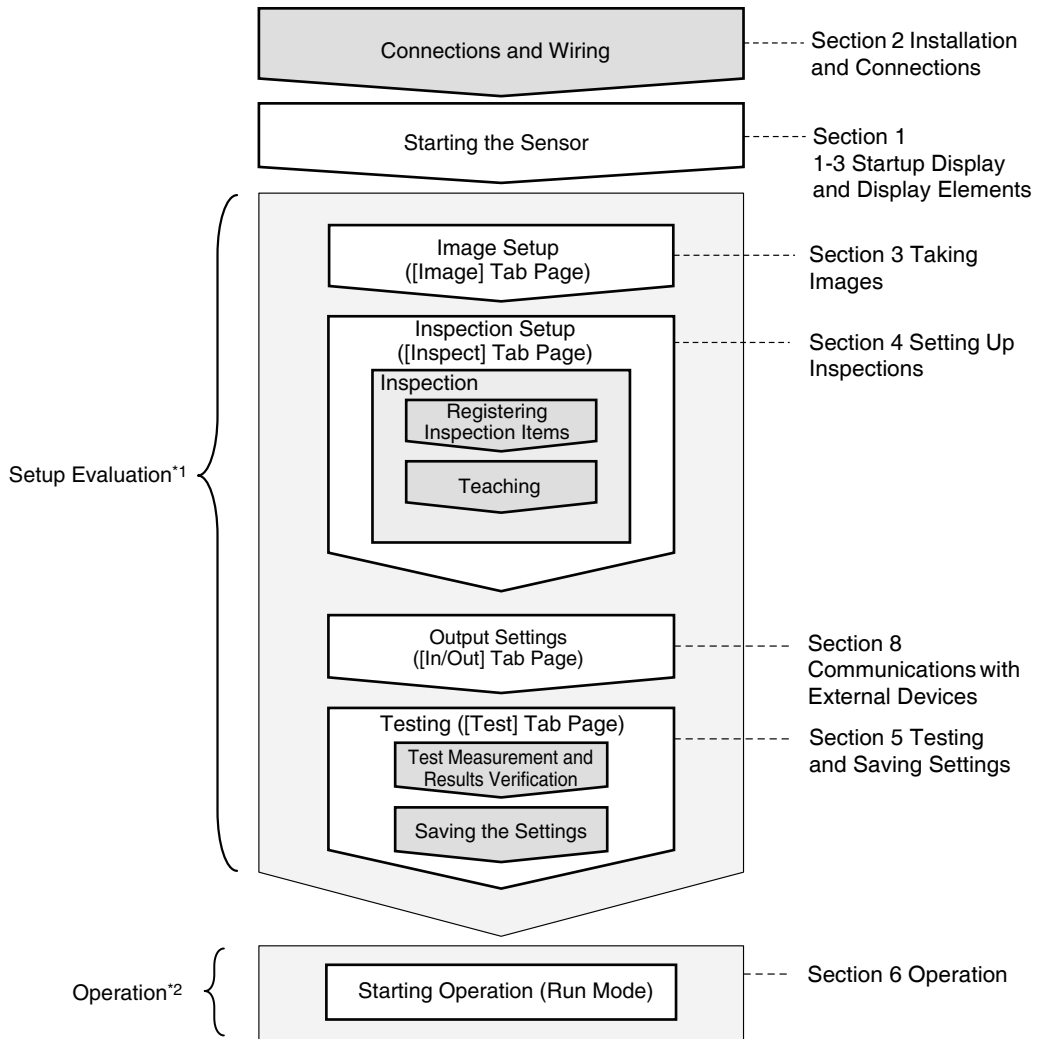

\*1: In Setup Mode, the Sensor can be set up and adjusted, but it does not output signals on the I/O lines.

\*2: In Run Mode, the Sensor performs measurements and outputs signals on the I/O lines.

# Installation and Connections

---

<b>2-1 System Configuration</b> .....	<b>18</b>
<b>2-2 Part Names and Functions</b> .....	<b>19</b>
<b>2-3 Installation</b> .....	<b>21</b>
<b>2-4 Wiring</b> .....	<b>26</b>
<b>2-5 Setting Up Ethernet</b> .....	<b>31</b>

# 2-1 System Configuration

## Parallel Interface Connection

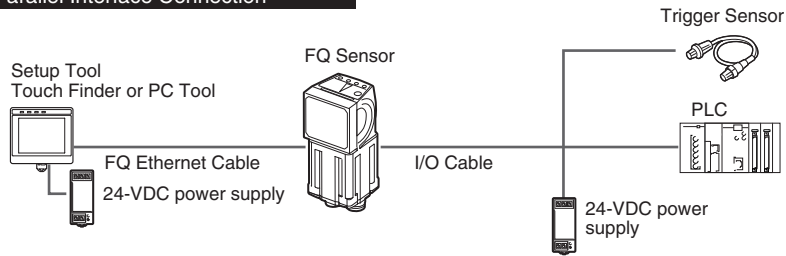

## Connecting to Ethernet

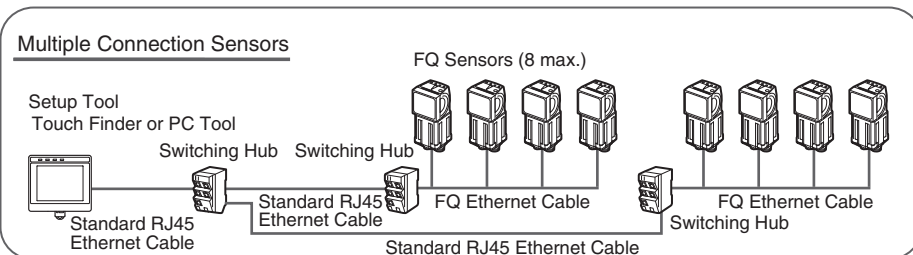
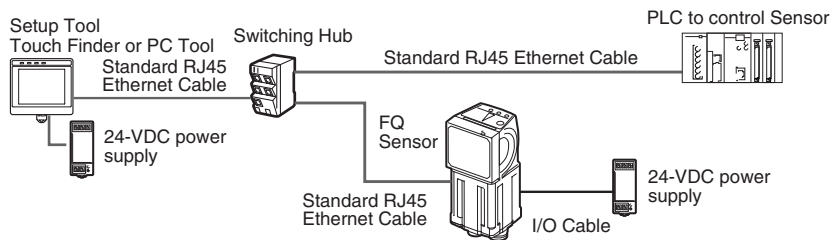

Product	Model number	Remarks
FQ Sensor	FQ-CR2□□□□□-M	This is the Sensor.
Touch Finder	FQ-D□□	This is a setup console (Software Version 1.3 or higher).
PC Tool	---	The PC Tool can be used instead of the Touch Finder (Software Version 1.3 or higher). If you register as a member, you can download the free PC Tool as a special service to purchasers. Refer to the <i>Member Registration Sheet</i> that is enclosed with the Sensor for the member registration procedure and the download procedure for special member software.
FQ Ethernet Cable	FQ-WN0□□	Connects the Sensors to external devices such as the Touch Finder, computers, and PLCs.
Standard RJ45 Ethernet Cable*1	---	Connects the Switching Hub to the Touch Finder, computers, and PLCs. Use a connector that complies with the FCC RJ45 standard. (STP (shielded twisted-pair) cable, category 5e or 6, impedance: 100 Ω)
I/O Cable	FQ-WD0□□	Connects the Sensor to the power supply and external devices.
Switching Hub	W4S1-0□□	Used to connect multiple Sensors to one Touch Finder or PC Tool.

\*1: The shape and dimensions of the Ethernet connector plug and jack are specified in ISO/IEC8877:1992 (JIS X 5110:1996) and RJ-45 of the FCC regulations. To prevent connector connection failures, the structure of the jack of this product does not allow insertion of plugs that do not comply with the standard. If a commercially available plug cannot be inserted, it is likely that the plug is non-compliant.

### Important

Do not connect network devices other than PLCs on the same network as the Touch Finder or computer. If another device is connected, the responsiveness of displays and settings of the Touch Finder or computer may become slow.

# 2-2 Part Names and Functions

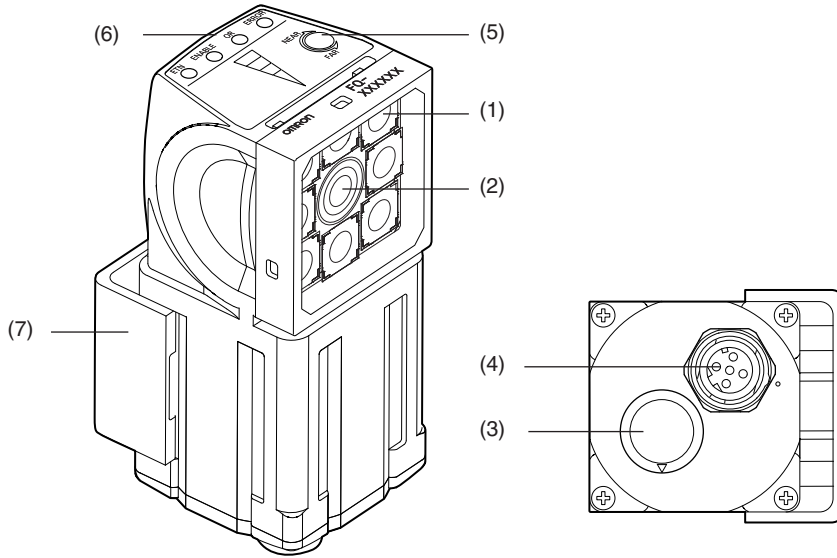

## FQ Sensor

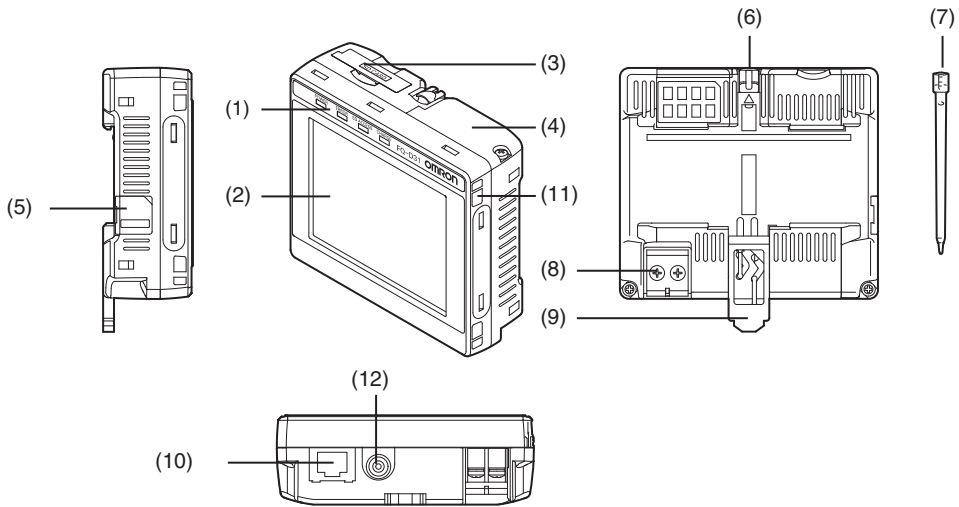

No.	Name	Description	
(1)	Lighting	LEDs for illumination	
(2)	Camera lens	This lens can be focused.	
(3)	I/O Cable connector	An I/O Cable is used to connect the Sensor to the power supply and external I/O.	
(4)	Ethernet cable connector	An Ethernet cable is used to connect the Sensor to external devices such as PLCs, the Touch Finder, or computers.	
(5)	Focus adjustment screw	Used to adjust the focus of the image.	
(6)	Operation indicators	OR	Lights orange when the OR output signal turns ON.
		ETN	Lights orange during Ethernet communications.
		ERROR	Lights red when an error occurs.  9-1 Error Table p. 154.
		BUSY	Lights green when the Sensor is executing a process.
(7)	Mounting Bracket	Used to mount the Sensor. The Mounting Bracket can be attached to the front, left side, right side, or back of the Sensor.	

# Touch Finder



No.	Name	Description	
(1)	Operation indicators	POWER	Lights green when the Touch Finder is turned ON.
		ERROR	Lights red when an error occurs.  9-1 Error Table p. 154.
		SD ACCESS	Lights yellow when an SD card is inserted. Flashes yellow when the SD card is being accessed.
		CHARGE <sup>*1</sup>	Lights orange when the Battery is charging.
(2)	LCD/touch panel	Displays the setting menu, measurement results, and images input by the camera.	
(3)	SD card slot	An SD card can be inserted.	
(4)	Battery cover <sup>*1</sup>	The Battery is inserted behind this cover. Remove the cover when mounting or removing the Battery.	
(5)	Power supply switch	Used to turn the Touch Finder ON and OFF.	
(6)	Touch pen holder	The touch pen can be stored here when it is not being used.	
(7)	Touch pen	Used to operate the touch panel.	
(8)	DC power supply connector	Used to connect a DC power supply.  p. 28	
(9)	Slider	Used to mount the Touch Finder to a DIN Track.	
(10)	Ethernet port	Used when connecting the Touch Finder to the Sensor with an Ethernet cable. Insert the connector until it locks in place.	
(11)	Strap holder	This is a holder for attaching the strap.	
(12)	AC power supply connector <sup>*1</sup>	Used to connect the AC adapter.	

\*1: Applicable to the FQ-D31 only.

# 2-3 Installation

## Installing the Sensor

### Installation Procedure

- 1** Align the tabs on one side of the Mounting Bracket with the slot on the Sensor.  
The FQ-XL Mounting Bracket can be attached to the back, side, or front of the Sensor.
- 2** Press the Mounting Bracket onto the Sensor until the other tabs click into place.
- 3** Use the following optical charts to check the field of view and installation distance of the Sensor so that it is mounted at the correct position.  
Tightening torque (M4): 1.2 N·m

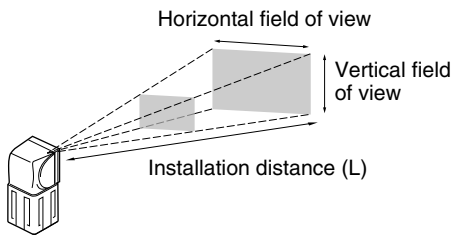
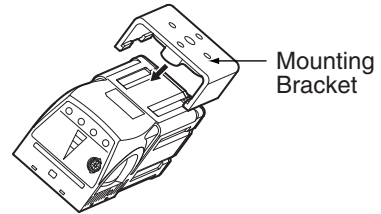

The optical chart indicates the horizontal field of view. The vertical field of view will be approximately 60% of the horizontal field of view.

**Note:** The tolerance is  $\pm 10\%$ .

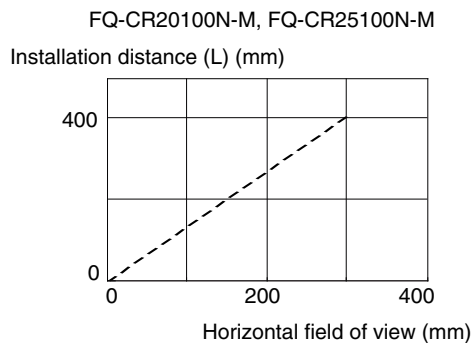
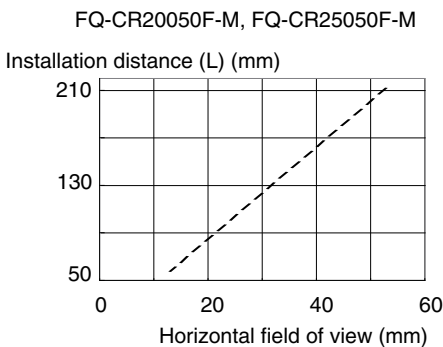
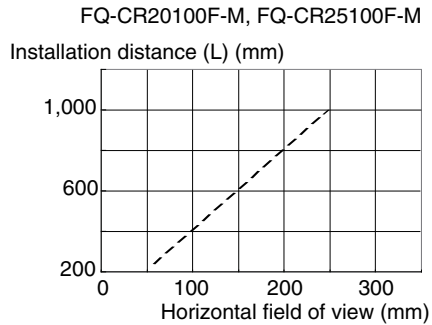
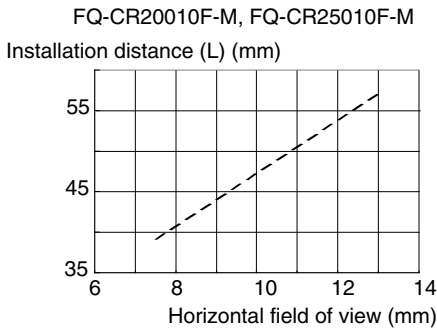

### Important

- There is a certain amount of deviation among Sensors in the center of the optical axis. For this reason, when installing the Sensor, check the center of the image and the field of view on the LCD monitor of the Touch Finder and in the PC Tool.

## Removal Procedure

- 1** Insert a flat-blade screwdriver between the Mounting Bracket and the Sensor case on either side and remove the Mounting Bracket.

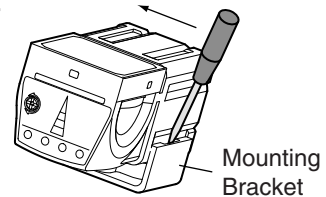

## Installing the Touch Finder

### Installation Precautions

Install the Touch Finder in the following orientation to allow sufficient heat dissipation.

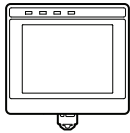

Do not mount it in the following orientations.

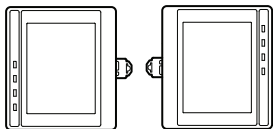

### Important

- To improve ventilation, leave space on both sides of the Touch Finder. The distance between the Touch Finder and other devices should be at least that shown in the following diagram.

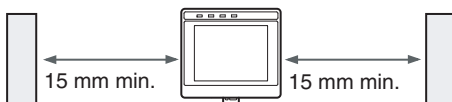

- Make sure that the ambient temperature is 50°C or lower. If it exceeds 50°C, install a cooling fan or an air conditioner and maintain the temperature at 50°C or lower.
- To prevent interference by noise, do not mount the Sensor on panels which contain high-voltage devices.
- To keep the level of noise from the surrounding environment to a minimum, install the Sensor and Touch Finder at least 10 m away from power lines.



## Mounting to DIN Track

### Installation Procedure

- 1** Press the slider on the Touch Finder to the top.
- 2** Hook the clip at the top of the Touch Finder on to the DIN Track.
- 3** Press the Touch Finder onto the DIN Track until the bottom clip clicks into place.

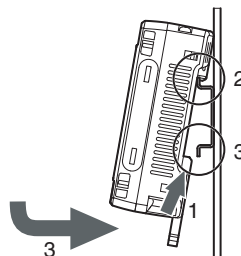

### Important

- Attach End Plates (sold separately) on the sides of the Touch Finder on the DIN Track.
- If other devices will be installed next to the Touch Finder on the same DIN Track, make sure that sufficient space is kept between the devices as indicated on previous page.
- Always hook the clip at the top of the Touch Finder on the DIN Track first. If the lower clip is hooked on first, the Touch Finder will not be mounted very securely.

### Removal Procedure

- 1** Pull down on the slider on the Touch Finder.
- 2** Lift the Touch Finder at the bottom and remove it from the DIN Track.

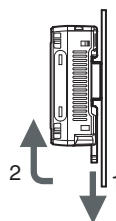

## Mounting to a Control Panel

The Touch Finder can be mounted on a panel using the FQ-XPM Panel Mounting Adapter.

### Important

- Always turn OFF the Touch Finder power before attaching or detaching the Panel Mount Adapter. Attaching or detaching with the power turned ON may cause a failure.

- 1** Set the Touch Finder in the Panel Mount Adapter.

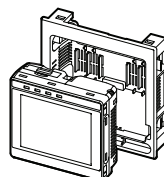

**2** Press the slider up on the Touch Finder.

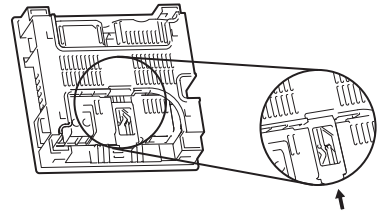

**3** Create holes in the panel for mounting.  
Refer to the following page for hole dimensions.

 p. 176

**4** Connect the cable to the Touch Finder.

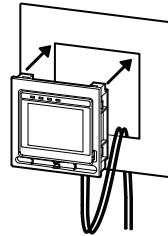

**5** Mount the Touch Finder with the Panel Mount Adapter from the front of the panel.

**6** Hook the hooks on the Mounting Bracket in the four holes of the Panel Mount Adapter and secure them with screws. (Tightening torque: 1.2 N·m)

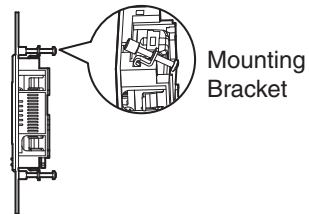

**7** Check that the Touch Finder is attached properly to the Panel.

## Using the Touch Finder as a Portable Device (with Battery)

The Touch Finder with a Battery can be used as a portable device. Use the strap when carrying it to prevent dropping it.

There are two types of straps (FQ-XH, sold separately), a Neck Strap and a Hand Strap.

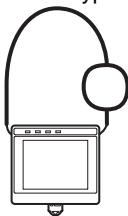

Neck Strap

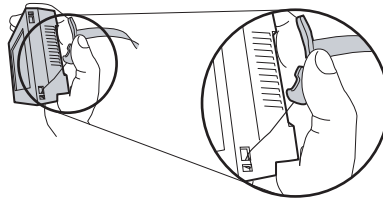

Hand Strap

**1** Attach the Mini-strap to the Touch Finder.

There are a total of four holes for attaching the Mini-strap on the left and on the right of the Touch Finder.

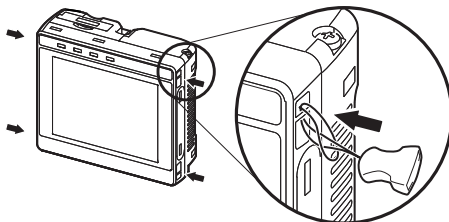

**2** Connect the Neck Strap or Hand Strap to the Mini-strap.

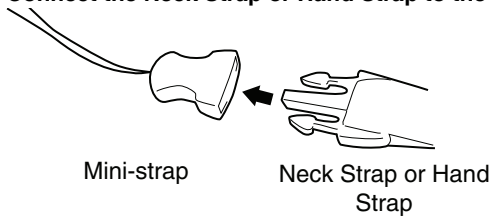

# 2-4 Wiring

## Wiring the Sensor

Connect the I/O Cable to the I/O Cable connector located at the bottom of the Sensor.

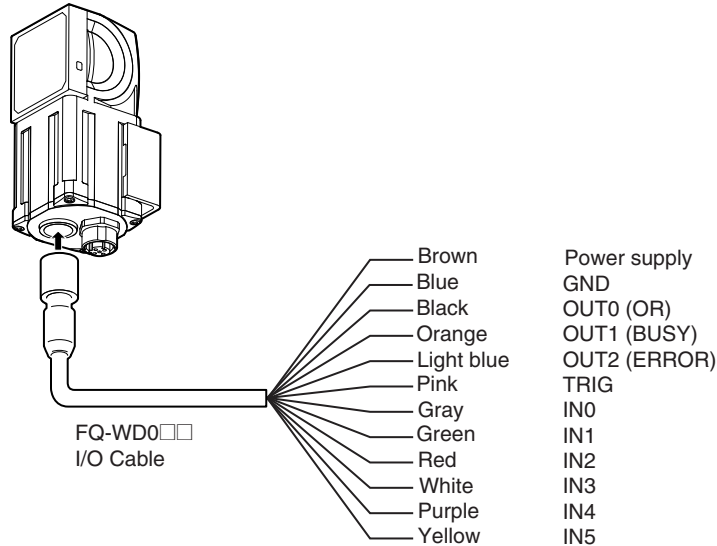

### Important

Cut off lines that are not required so that they do not come into contact with the other signal lines.

Classification	Signal	Application
Power supply	Power supply (24 V)	These terminals are for the external power supply (24 V).
	GND	<b>Important</b> Wire the power supply separately from other devices. If the wiring for other devices is placed together or in the same duct as the wiring for the Sensor, the influences of electromagnetic induction may cause the Sensor to malfunction or may damage it.
Inputs	TRIG	This terminal is the trigger signal input.
	IN0 to IN5	These are the command input terminals.
Outputs	OUT0 (OR)	By default, this is the OR output signal (overall judgement). The assignment can be changed to an individual judgement signal from OR0 to OR31.
	OUT1 (BUSY)	By default, this is the BUSY output signal. The assignment can be changed to an individual judgement signal from OR0 to OR31.
	OUT2 (ERROR)	By default, this is the ERROR output signal. The assignment can be changed to an individual judgement signal from OR0 to OR31.

### Note

The assignments of I/O signals can be changed.

 Section 8 Communications with External Devices: p. 95

## I/O Signal Circuit Diagrams

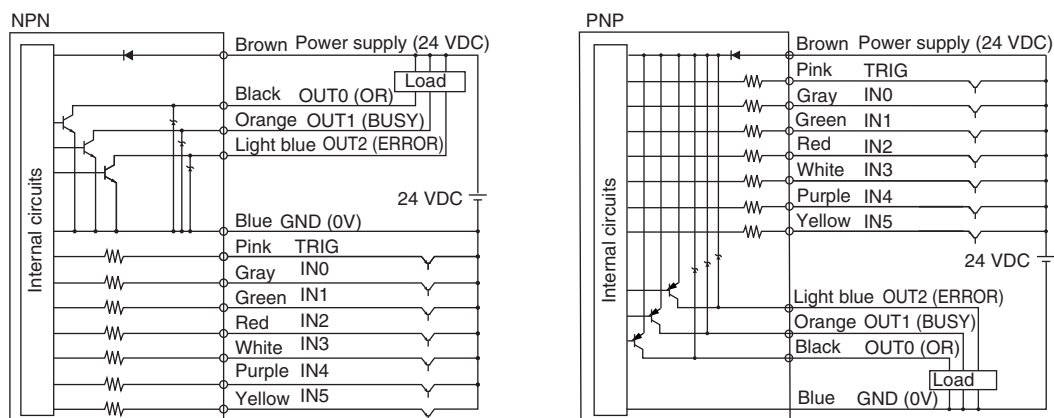

### Important

#### Preventing Chattering

- The Sensor is equipped with an anti-chattering function, but if the chattering is 100  $\mu$ s or longer, a faulty input may occur. (Input signals of 99  $\mu$ s or shorter are ignored. Signals of 100  $\mu$ s or longer are treated as input signals.)
- Use no-contact output devices (e.g., SSR or PLC transistor output) for the input signals. If contacts (e.g., relay) are used, chattering may cause the trigger to be input again during execution of a measurement.

## Power Supply Specifications When a Switching Regulator Is Connected

Use a power supply that meets the following specifications. (The power supply is sold separately.)

Item	Model	
	FQ-CR2□010F-M/ FQ-CR2□050F-M	FQ-CR2□100F-M/ FQ-CR2□100N-M
Power supply voltage	24 VDC (21.6 to 26.4 V)	
Output current	1.25 A max.	2.5 A max.
Recommended Power Supply	S8VS-030024□ (24 VDC, 1.25 A)	S8VS-060024□ (24 VDC, 2.5 A)
External power supply terminal screws	M4 (Tightening torque: 1.2 N·m)	

### Important

Supply power from a DC power supply for which measures have been applied to prevent high voltages (e.g., a safety extra low voltage circuit).

If UL certification is required for the overall system, use a UL Class II DC power supply.

## Attaching the LED Warning Label

Attach the enclosed LED warning label to the cable or other location. The LED warning label must be attached to a location that is readily visible from the Sensor.

Attachment Example

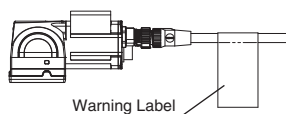

Warning Label

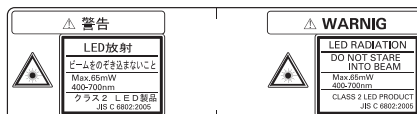

# Wiring the Touch Finder

## Power Supply Wiring

### Connecting the Power Supply

- 1** Loosen the two terminal screws using a Phillips screwdriver.
- 2** Attach crimp terminals to the power lines. Secure the positive and negative lines as indicated using M3 screws.  
Power supply tightening torque: 0.54 N-m
- 3** In environments where there is excessive noise, attach a ferrite core (ZCAT1730-0730 from TDK or the equivalent) to the power supply cable.

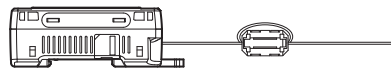
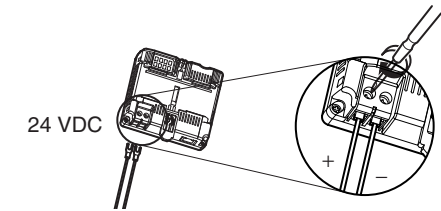

When you attach the ferrite core to the power supply cable, wrap the cable only one time.

### Turning ON the Touch Finder

- 1** Remove the cover from the power switch on the left side of the Touch Finder.
- 2** Press the switch toward *ON*.

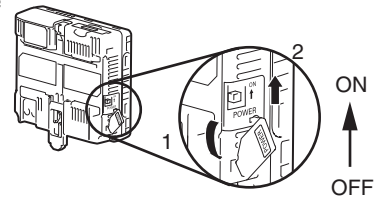

### Power Supply Specifications

Use a power supply that meets the following specifications. (The power supply is sold separately.)

Item	Description
Power supply voltage	24 VDC (21.6 to 26.4 V)
Output current	0.65 A min.
Recommended Power Supply	S8VS-01524□ (24 VDC, 0.65 A)
External power supply terminal screws	M4 (tightening torque: 1.2 N-m)
Recommended power line wire size	AWG16 to AWG22 (length of 5 m max.)

#### Important

- Supply power from a DC power supply for which measures have been applied to prevent high voltages (e.g., a safety extra low voltage circuit).  
If UL certification is required for the overall system, use a UL Class II DC power supply.
- When using the FQ-D31, do not connect a switching regulator and AC Adapter (FQ-AC□) at the same time.

## Charging the Battery

This section describes how to charge and install the FQ-D31 Battery and provides applicable precautions.

Charge the Battery while it is attached to the Touch Finder.

Use the AC adapter to charge the battery.

### Mounting the Battery in the Touch Finder

- 1 Remove the screw from the battery cover on the top of the Touch Finder, slide the cover in the direction of the arrow, and open the battery cover.**

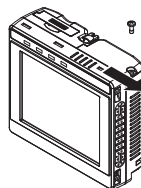

- 2 Face the rounded side of the battery toward the back of the Touch Finder and insert the battery.**

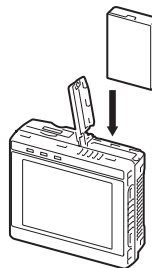

#### Important

Do not insert the battery in the wrong orientation.

- 3 Close the battery cover, slide the battery cover in the direction of the arrow, and tighten the screw on the battery cover.**

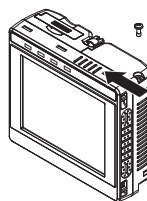

- 4 Attach the AC adapter to the Touch Finder to start charging the battery.**

The CHARGE indicator will be lit while the battery is being charged. It will go out when charging the battery has been completed.

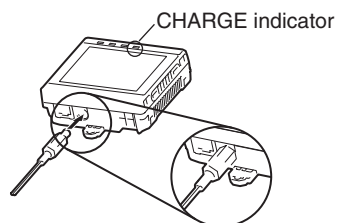

#### Note

The Touch Finder will operate even if the AC adapter is connected when no battery is mounted in the Touch Finder.

## Important

- If the Touch Finder (FQ-D31) will be installed permanently or semi-permanently, remove the Battery (FQ-BAT1). If the rated temperature is exceeded with the Battery inserted, the protective circuit may activate and stop the Touch Finder.
- The battery complies with the following recycling regulation.



- California regulations concerning perchlorate:  
This product is a lithium battery that contains perchlorate, which is regulated by the State of California. Please comply with these regulations. For details see the following URL:  
[www.dtsc.ca.gov/hazardouswaste/perchlorate/](http://www.dtsc.ca.gov/hazardouswaste/perchlorate/)



## 2-5 Setting Up Ethernet

### Connecting to Sensors from the Touch Finder

When the Sensor is used with a Touch Finder, IP addresses are automatically assigned. No settings are required to use Ethernet.

However, if a Sensor or Touch Finder is connected to a network where a PLC or computer is already connected, the Ethernet must be set to be compatible with the existing network.

- Sensor

▶  (Setup Mode) – [Sensor settings] – [Network] – [Ethernet]

- 1** Set [Auto connection] to [OFF].
- 2** Set the IP address and subnet mask according to the network settings.

- Touch Finder

▶  (Setup Mode) – [TF settings] – [Ethernet]

- 1** Set the IP address and subnet mask according to the network settings.

### Connecting to Sensors from External Devices Such as PLCs

Set the IP address of the Sensor according to the network where the external devices, such as PLCs, are connected.

▶  (Setup Mode) – [Sensor settings] – [Network] – [Ethernet]

- 1** Set [Auto] to [OFF].
- 2** Set the IP address and subnet mask according to the network where the external devices, such as PLCs, are connected.

**Note**

If you connect OMRON CS/CJ-series PLCs to the Ethernet, the following default IP addresses are assigned to the PLCs.

- IP address: 192.168.250.*node\_address*

### Connecting to Sensors from a Computer Using the PC Tool

When connecting the Sensor directly to a computer using an Ethernet Cable, set the network settings on the computer as given below. Setting a fixed IP address is not required if there is a hub between the computer and Sensor and a DHCP server is used.

The following procedure is for Windows XP.

- 1** Select [Control Panel] from the Windows Start Menu.
- 2** Click [Network and Internet Connections] in the control panel and then double-click [Network Connections].

- 3** Right-click the [Local Area Connection] Icon and select [Properties].

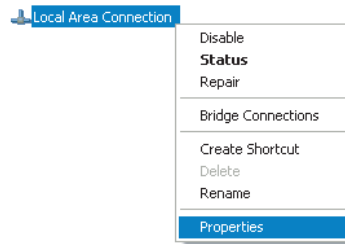

- 4** On the [General] Tab Page, double-click *Internet Protocol (TCP/IC)*.

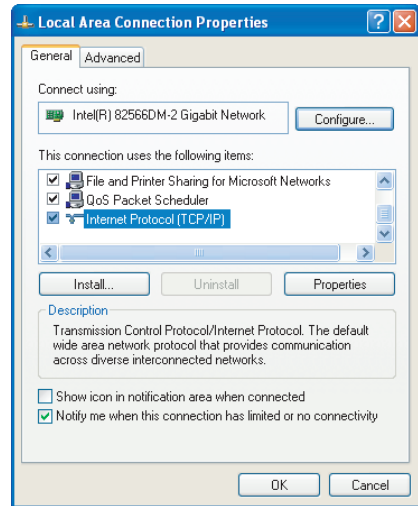

- 5** Select the *Use the following IP address* Option and enter the following IP address and subnet mask.

- IP address: 10.5.5.101
- Subnet mask: 255.255.255.0

- 6** Click the [OK] Button. This completes the settings.

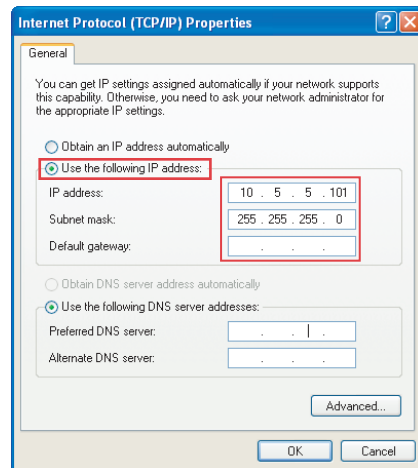

# Taking Images

---

<b>3-1 Selecting a Sensor for Configuration</b> . . . . .	<b>34</b>
<b>3-2 Adjusting Image Quality</b> . . . . .	<b>35</b>
<b>3-3 Adjusting the Object Position</b> . . . . .	<b>41</b>
<b>3-4 Preventing Mutual Interference of Multiple Sensors</b> . . . . .	<b>43</b>
<b>3-5 Setting How the Image is Processed After Scanning</b> . . . . .	<b>44</b>

# 3-1 Selecting a Sensor for Configuration

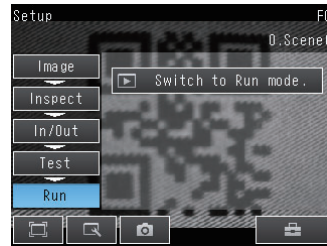

If multiple Sensors are connected to a single Touch Finder or computer, you can select the Sensor that you want to set up.

- 1 Press [Run].**  
This will enable setting the current Sensor into RUN Mode before selecting another Sensor.
- 2 Then press [Switch to Run mode].**

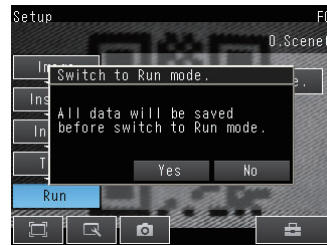

- 3 Press [Yes].**



- 4 Press  - [Switch Sensor].**
- 5 Press the image of the Sensor to be set up.**  
 will be displayed for Sensors that are not yet set.

**Note**

Once the Touch Finder detects and records a Sensor, the display order for showing more than one Sensor is fixed. Even if the system configuration is changed to reduce the number of Sensors, the previous display location will remain for Sensors that were removed. To update displays of multiple Sensors to the current connection status, press [] - [Auto connect] on the right of the display in step 5, above, to automatically reconnect.

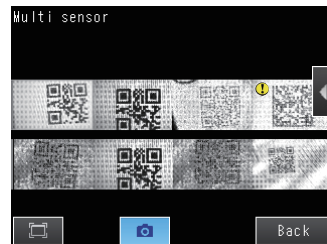

- 6 Press  - [Sensor settings] to return to Setup Mode.**



- 7 Press [Yes].**

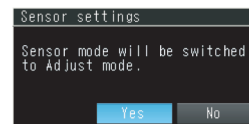

# 3-2 Adjusting Image Quality

## Adjusting the Focus

### ► [Image] – [Camera setup]

**1 Display the Camera Setup Display.**  
The focus can be seen as a numerical value. The higher the value, the better the focus.



Focus Level

**2 Manually adjust the focus using the focus adjustment screw on the Sensor while checking the image and focus value on the Touch Finder.**

In the default settings, the field of view is set to the narrowest setting.

**3 Press [Back].**

Focus adjustment screw

Turn clockwise to focus on closer objects.  
(The field of view will narrow.)



Turn the screw counterclockwise to focus on objects at a distance.  
(The field of view will widen.)

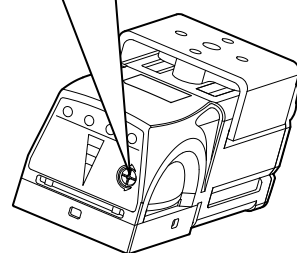

### Important

- Turn the focus adjustment screw clockwise or counterclockwise a little bit to make sure that it has not already reached the dead stop. Do not force the screw if it does not rotate anymore. This will damage the Sensor.
- Do not turn the focus adjustment knob with a force that is greater than 0.1 N·m. This may damage it.

## Increasing the Brightness of the Image

The brightness of the display can be adjusted by adjusting the shutter speed and gain. To automatically adjust the shutter time and gain, press the [AUTO] button in the display. To set the shutter speed and gain individually, follow the steps below.

The image can be made brighter by increasing the shutter speed.

- 1** Press [Shutter speed] on the right side of the display.
- 2** Move the adjustment bar left or right to adjust the brightness of the display.
- 3** Press [OK].



### Important

The exposure time is longer when a larger value is set. This may cause the image to blur if the object is moving fast. When using the reader on a high-speed line, verify that the image is not blurred under actual operating conditions.

If sufficient brightness cannot be obtained by adjusting the shutter speed, increase the gain.

- 1** Press [Gain] on the right side of the display.
- 2** Move the adjustment bar left or right to adjust the brightness of the display.
- 3** Press [OK].



**Important**

If the image brightness fluctuates and is not stable each time an image is captured, turn on brightness correction.

- ▶ **[Brightness]** - [**◀**] - **[Brightness correction]**.
- ▶ **[Shutter speed]** - [**◀**] - **[Brightness correction]**.
- ▶ **[Gain]** - [**◀**] - **[Brightness correction]**.

When brightness correction is turned on, the brightness stabilizes but the image timing is delayed by 25 ms. Make sure that suitable images of the measured objects are captured when brightness correction is on.

**Timing chart when brightness correction is ON**

Timing Chart When the Brightness Correction Mode Is ON

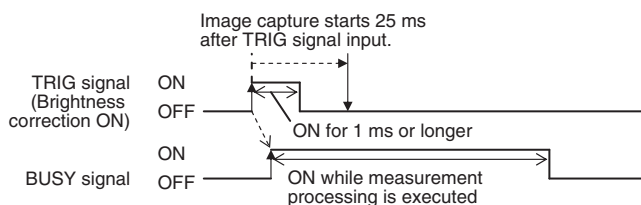

Timing chart when brightness correction is off: p.97

**Capturing Moving Objects Without Blur**

For fast moving objects, blurring can be reduced by decreasing the shutter speed.

- 1** Press **[Shutter speed]** on the right side of the display.
- 2** Move the adjustment bar left or right to adjust the gain.
- 3** Press **[OK]**.

If sufficient brightness cannot be obtained by adjusting the shutter speed, increase the gain.

**Important**

When the shutter speed is decreased, the image becomes darker. Increasing the gain can improve the brightness, but the image will become grainier. Make sure that measurement stability is not affected under actual operating conditions.

**Improving the Image Quality of Objects with Shiny or Metallic Surfaces**

When measuring objects with shiny or metallic surfaces, light may reflect off the surface and affect the image. Two functions are available to remove reflected light from the image.

Function	Description
HDR (High Dynamic Range)	Widens the dynamic range to improve the image quality of objects with contrasting light and dark areas.
Polarizing filter	A polarizing filter can be attached to the sensor to remove specular reflection.

**Hints**

• The object being inspected can be stopped	Use the HDR function
• The object being inspected cannot be stopped	Use the polarizing filter

## HDR Function

This function widens the dynamic range to improve the image quality of objects with contrasting light and dark areas. This function is particularly effective for objects with highly contrasting light and dark areas, and when bright objects are mixed together with dark objects.

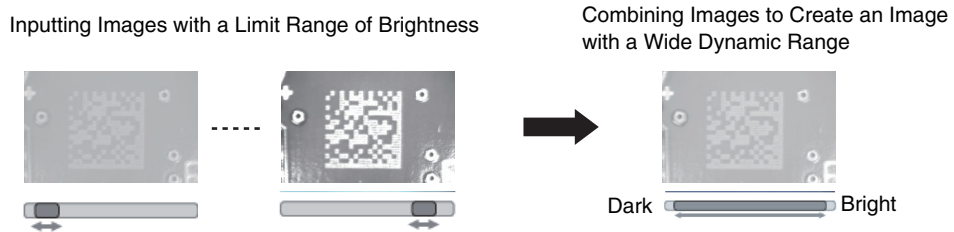

Note the following points:

- Only use the HDR function when the inspected object is stopped. Images are captured using different shutter speeds and combined. If the object moves, a blurred image will result.
- Because images of differing brightness are combined, the resulting combined image will have slightly less contrast.

### ► [Image] - [Camera setup]

- 1 Press [◀] - [HDR] on the right side of the display.**  
Select the HDR level.
- 2 Press [◀] - [Brightness] on the right side of the display.**
- 3 Move the adjustment bar left or right to adjust the brightness.**  
A larger "Brightness" value makes the image brighter.  
A smaller "Brightness" value makes the image darker.

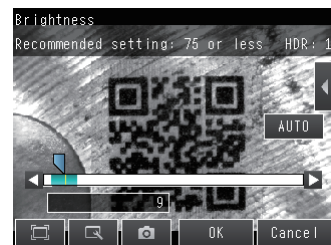



- Relation between brightness parameter and image brightness

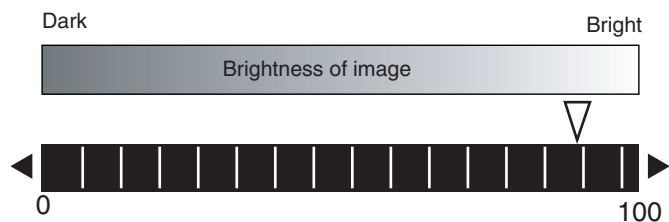

- Relation between brightness parameter and shutter time

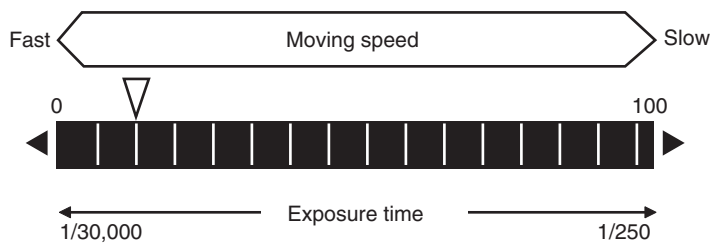

**4 To automatically adjust HDR, press the [AUTO] button.**

**Note**

- If the object is changed after the HDR function is set, press the [AUTO] button to repeat auto adjustment.
- If auto adjustment does not achieve the desired result, press [◀] - [HDR] on the right side of the display and manually select the optimum HDR mode.
- As shown below, a higher level gives a wider combined dynamic range.

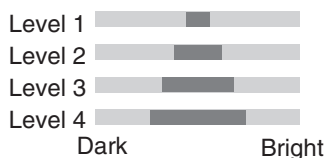

- If reflected light cannot be sufficiently removed using the HDR function, use the polarizing filter in combination with the HDR function.

## Using a Polarizing Filter

Specular reflections can be eliminated from an image by attaching a FQ-XF1 Polarizing Filter to the Sensor.

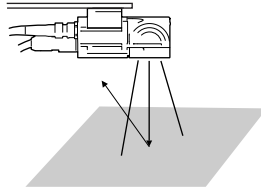

Observe the following precautions.

- The image will be darker compared to when no filter is used.
- If the image becomes too dark, adjust the brightness.

 p. 39

### • Mounting the Filter

**1** Hook the filter in the hole at the top of the Sensor.

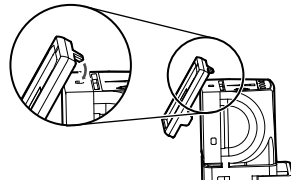

**2** Using the top section as a pivot point, pull down the filter so that it attaches to the Sensor.

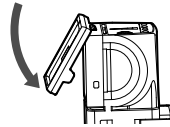

# 3-3 Adjusting the Object Position

If objects are moving, the position in the image of the characteristic that is to be measured will vary according to the timing of the trigger signal. The FQ Sensor offers two different ways to adjust this position variation.

Function	Description	Reference
Trigger delay	A delay can be applied from when the trigger (the TRIG signal) is input until when the image is input, to synchronize the timing of image input with the speed of the moving objects.	p. 41

## Adjusting the Image Timing

The internal timing for taking an image can be set to be delayed in relation to the external trigger signal. This can be used to adjust the object position in the image, e.g., if an external trigger sensor is used. If the object position still varies in the image the Position Compensation function must also be used.

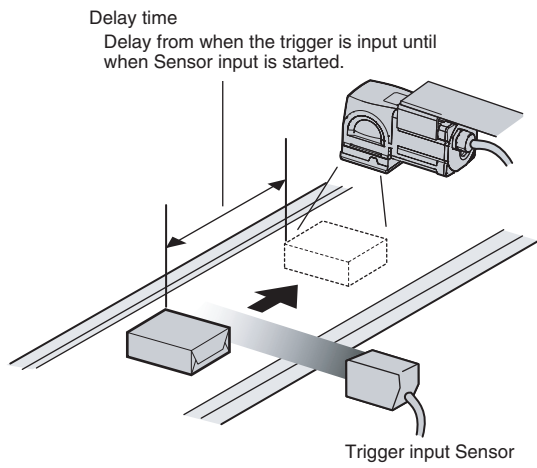

### ► [Image] – [Trigger setup] – [Trigger delay]

- 1** A TRIG signal is input.  
Images are input continuously.
- 2** Select the image with the measurement object in the center using [◀] and [▶].
- 3** Press the image.
- 4** Press [OK].

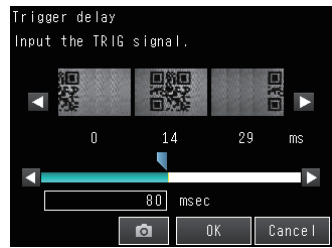

**Note**

The delay time can be set using the adjustment bar or by directly entering a value.

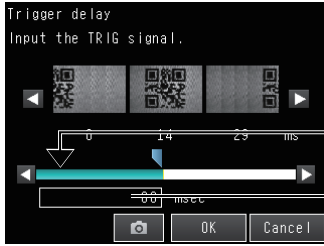

Move the bar to the left or right.

Or

Directly input the delay time.

# 3-4 Preventing Mutual Interference of Multiple Sensors

When the same trigger signal is input to multiple Sensors, the lighting from one Sensor may affect the measurements of the other Sensors. This is called mutual interference. This kind of interference can be prevented offsetting the image input timing of each Sensor from when the trigger signal is received.

Example:

A trigger (i.e., the TRIG signal) is input to Sensor 0 and Sensor 1 at the same time.

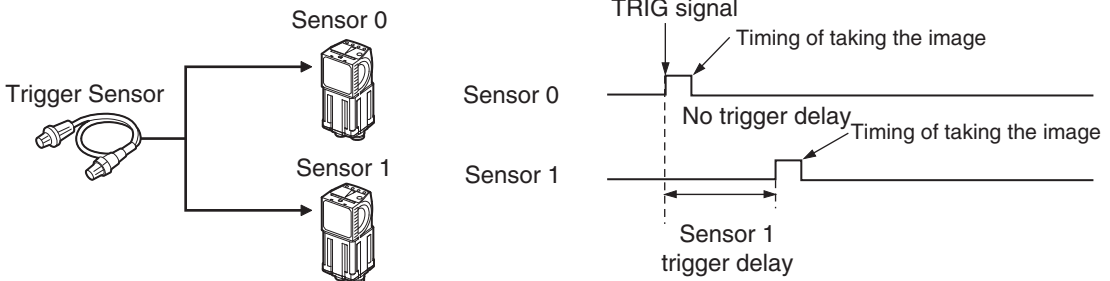

Sensor 0 immediately begins image input when the trigger is input.  
Sensor 1 begins image input after the specified time has passed.

### 1 Change to the setup for to Sensor 1.

p. 34

### 2 Press [Image] – [Trigger setup] – [Trigger delay].

### 3 Set the trigger input delay time for Sensor 1.

p. 41

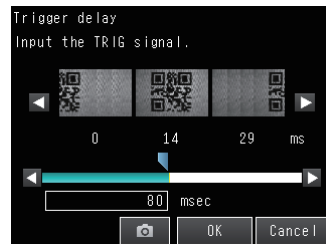

#### Important

- The delay time for preventing mutual interference must be longer than the shutter time. When the lighting built into the Sensor is used, the shutter time is 4 ms max. Therefore make the delay at least 4 ms.

## 3-5 Setting How the Image is Processed After Scanning

The method of processing the image after scanning can be set. This reduces scanning failures. Three filter processes can be set, and Smooth, Dilate, Erosion, or Median can be selected for each filter process.

► [Image] - [Filter Setup] - [◀] - [Select Filter]

**1** Press the number of the filter you wish to set.



**2** Set the filter type and filter size.

Parameter	Selections	Description
Filter Type	Smooth Dilate Erosion Median None (default)	Sets the filter type.  Smooth: Makes the image smoother. Dilate: Makes the periphery around any white parts white. If the code is black, makes the cell smaller. Erosion: Makes the periphery around any black parts black. If the code is black, makes the cell larger. Median: Reduces noise.
Filter Size	3 × 3 (default) 5 × 5	Sets the filter size for filter processing. Setting a larger filter size increases processing time.  3 × 3: Filter processing takes place using the density value of each pixel and the surrounding 8 pixels. 5 × 5: Filter processing takes place using the density value of each pixel and the surrounding 24 pixels.

# Setting Up Inspections

---

4-1 Setup Procedure for Inspection Items .....	46
4-2 Configuring Inspection Items .....	47
4-3 Setting 2D Code Inspection Conditions .....	49

# 4-1 Setup Procedure for Inspection Items

The basic steps for setting up inspection items are shown below.

**Step 1**      Configuring Inspection Items



**Step 2**      Teaching

If measurements are unstable

**Step 3**      Setting Detailed Items



**Step 4**      Re-teaching

**Note**

- 
- Up to 32 inspection items can be used on the FQ-CR2.
-



# 4-2 Configuring Inspection Items

## Adding New Inspection Items

1 Press [Inspect] – [Inspection].



2 Press an unused inspection item number.

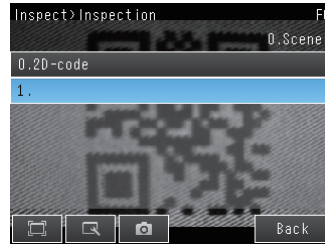

3 Press [Add item.] on the menu.

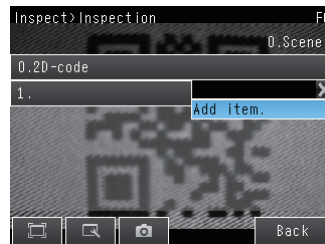

4 The Settings tab appears.

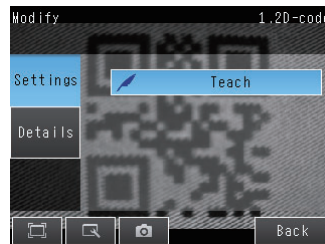

When registering multiple inspection items, press the inspection item number after 1.--- and set it in the same way.

### Note

If more than six inspection items are set, drag the  icon at the bottom of the menu up to display the next inspection item numbers.

## Modifying Existing Inspection Items

- 1 Press the number of the inspection item to be set.

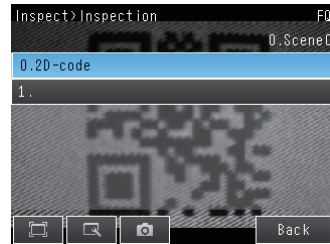

- 2 Press [Modify] on the menu.



## Deleting Inspection Items

- 1 Press the number of the inspection item to be deleted.
- 2 Press [Delete] on the menu.

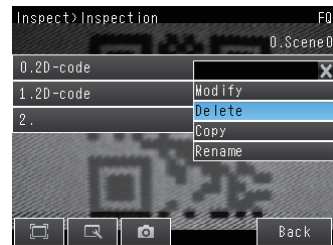

### Note

Executing Similar Measurements in Different Places

→ Copy an inspection item that is already registered: [Copy].

→ Change the name of an inspection item: [Rename].

# 4-3 Setting 2D Code Inspection Conditions

## 2D Codes

The sensor scans and verifies 2D codes.

The scan result and verification result can be externally output.

Codes that can be scanned are Data Matrix (EC200) and QR Codes.

### Inspection image

When the inspection region is set, the code image is displayed, and teaching is executed, the code type and detailed parameters are automatically set.

### Inspection image

One 2D code is scanned in one inspection region. If there are multiple 2D codes in the inspection region, the first scanned result is output.

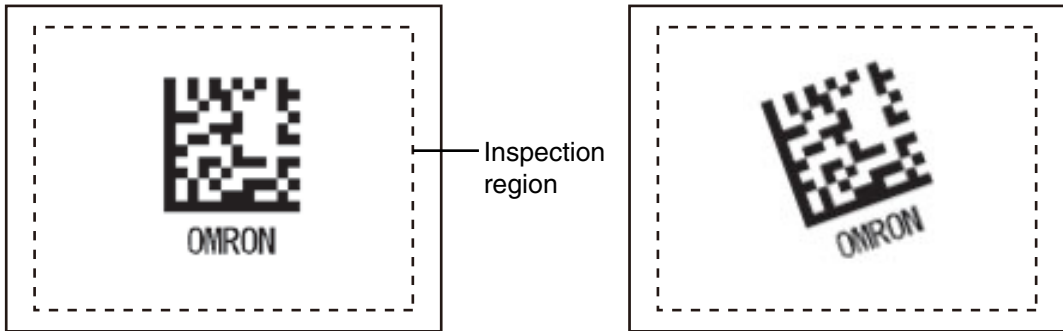

## Operation Procedure

### Step 1 Select the Inspection Item

#### ► [Inspect] - [Modify]

- 1 A 2D code is preset in Inspection item 0.**  
To add an Inspection Item, press a blank Inspection Item and add.
- 2 Press the Inspection Item that you wish to set.**
- 3 Press [Modify].**



## Step 2 Teaching

"Teaching" is the process of registering the area to be inspected and the 2D code within that area as master data.

► [Inspect] - [Modify] - [Add item] - [2D-code] - [Settings] tab

**1** Press [Teach].

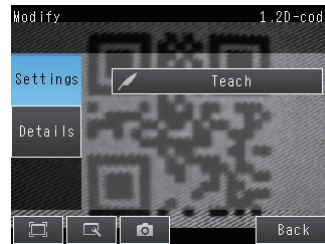

**2** Display the image of the 2D code you wish to register.



**3** To change the inspection region, press ◀ [Insp. region] on the right side of the display, and adjust the following:

- Change the size  
Press one of the four corner points of the frame.
- Move the position  
Drag the inside of the frame to move it.

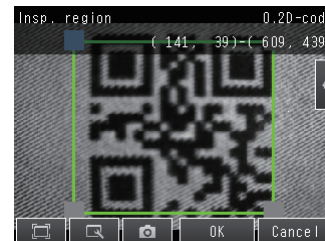

**4** Press [TEACH]. Scanning is executed and the result is displayed.

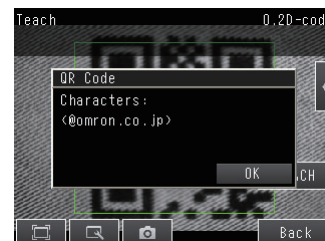

## Detailed Parameters

Each parameter is automatically set by default.

If scanning cannot be performed because the code is different or otherwise, set the detailed parameters manually and execute teaching.

► **[Inspect] - [Modify] - [Add item] - [2D-code] - [Details] tab**

### Detailed Parameter Settings

Parameter	Setting	Description
Code type	DataMatrix QR Code Auto (default)	Sets the type of code to be scanned.
Auto length	OFF ON (default)	Sets whether the code length is automatically acquired.
Reverse	Normal Reverse Auto (default)	Sets normal image or reverse (mirror) image.
Code color	Black White Auto (default)	Sets the color of the code.
Fast mode	ON, OFF (default)	Sets fast mode. When ON, the scanning time is shorter. For certain work, the scanning time may be longer when Fast mode is ON. Please use after performing test measurements and verifying the scanning speed.
Shape (DataMatrix only)	Square Rectangle Auto (default)	Sets the code shape.
QR Code Model (QR Code only)	Model 1 Model 2 Auto (default)	Sets the QR Code model.
Error Correction Level (QR Code only)	L (7%) M (15%) Q (25%) H (30%) Auto (default)	Sets the error correction level (ECC level). (The ECC level of DataMatrix is fixed at 200.)
Cell (QR Code only)	21 × 21, 25 × 25, 29 × 29, 33 × 33, 37 × 37, 41 × 41, 45 × 45, 49 × 49, 53 × 53, 57 × 57, Auto (default)	Sets the number of code cells.
Cell (DataMatrix only)	Shape: Square 10 × 10, 12 × 12, 14 × 14, 16 × 16, 18 × 18, 20 × 20, 22 × 22, 24 × 24, 26 × 26, 32 × 32, 36 × 36, 40 × 40, 44 × 44, 48 × 48, 52 × 52, 64 × 64, Auto (default)  Shape: Rectangle 8 × 18, 8 × 32, 12 × 26, 12 × 36, 16 × 36, 16 × 48, Auto (default)	Sets the number of code cells.

### Important

- With the exception of "Fast mode", the detailed parameters are set when [Teach] is pressed.
- When the "Code type" setting is changed, some settings are initialized as shown below.

Parameter	Initialized due to "Code type" change
Code type	Initialized
Auto length	
Reverse	
Code color	
Fast mode	
Shape	Initialized
QR Code Model	Initialized
Error Correction Level	Initialized
Cell	Initialized

## Inspection Data that Can be Logged

The following values can be logged as inspection data.

Inspection item	Value range	Description
Cell recognition rate	0 to 100	Outputs the cell recognition rate.

## If an Error Occurs

### If a teaching error occurs

If scanning of the 2D code fails, a teaching error message appears. It is likely that low contrast caused unstable scanning. Adjust the brightness to increase the contrast of the 2D code.

 Increasing the Brightness of the Image: p. 36

# Testing and Saving Settings

---

5-1 Performing Test Measurements .....	54
5-2 Shortening the Measurement Takt Time .....	56
5-3 Checking a List of All Inspection Item Results .....	57
5-4 Saving Data to the Sensor .....	58

# 5-1 Performing Test Measurements

After completing the settings in the [Image], [Inspect], and [In/Out] Tab Pages, move to the [Test] Tab Page. The displayed image is measured automatically. This is called a test measurement. A test measurement is used to verify that the settings that have been made will produce stable results and, if necessary, to fine-tune the settings. An overall judgement of all inspection items can be performed. Test measurements can be performed for through images (default) or saved images.

## Performing Test Measurements with Samples

### ► [Test] – [Continuous test]

- 1 Press [Graphics+Details].
- 2 Input an image of a previously prepared object. Check the judgement results.
- 3 When you finish checking the results, press [Back].

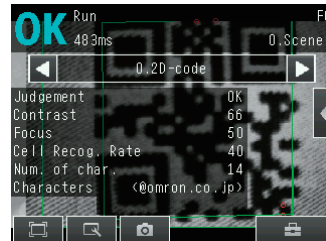

#### Note

The same five types of displays are available for the [Continuous test] on the [Test] Tab Page, i.e., [Graphic], [Graphics + Details], [All results/region], [Trend monitor], and [Histogram]. Press the [Back] Button to access the menu to change the display.

 Changing the Run Mode display: p. 62

## Performing Test Measurements with Saved Images (Re-measuring)

This Sensor can save measured images in the Sensor's built-in memory or on an SD card. Test measurements can be performed using these saved images. This function is useful for adjusting the judgement parameters when objects are not available.

### ► [Test] – [Continuous test] – (Any display)

- 1 Press  - .





**2** Select [Log] or [File].

Images in the Sensor's built-in memory: Press *Log*.

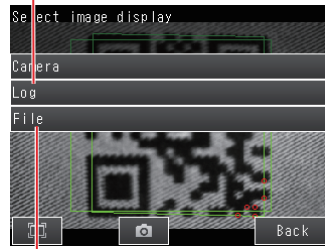

Images on the SD card: Press *File*.

**3** The display switches to the saved image and measurements are taken again.

 Saving images: p. 88

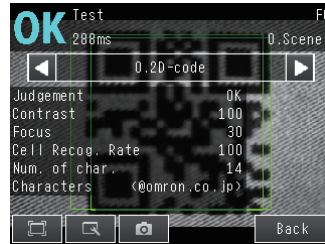

# 5-2 Shortening the Measurement Takt Time

## Checking the Measurement Takt Time

The measurement time of this Sensor can be checked from the Setup or Run Mode display.

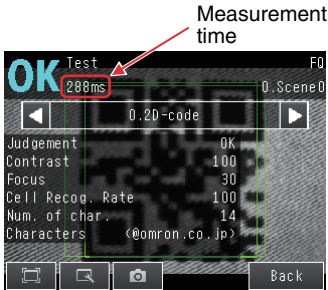

The measurement time is the time taken from when a trigger is input until when all measurement processes are executed.

During the measurement time, this Sensor will not accept the next trigger. This means that the measurement time is the basic measurement takt time.

Inputting a trigger

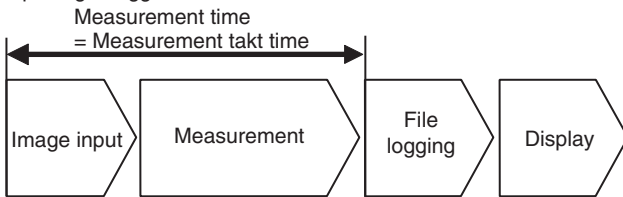

## Increasing Image Input Speed

With the partial input function, it is possible to input only images that are in the region that is necessary for measurements.

The image measurement region becomes smaller and thus the image input time is shortened.

### ► [Image] – [Camera setup]

- 1 Press [◀] – [Partial input] on the right side of the display.
- 2 Change the input size.
- 3 Press [OK].
- 4 Press [Back].



### Important

If you use partial input, perform teaching again.

## 5-3 Checking a List of All Inspection Item Results

Individual judgement results for all inspection items can be checked in a list. The individual inspection items can be selected to change the judgement parameters.

### ► [Test] – [Continuous test]

- 1 Press [All results/region] to display the list.

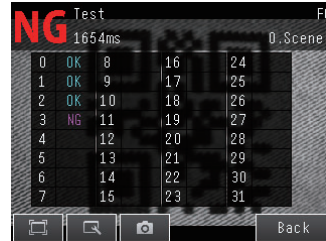

The screenshot shows a test results screen titled "Test" with a red "NG" indicator in the top left. The screen displays a grid of inspection items with their status and coordinates. The status "OK" is shown in green and "NG" in red. The coordinates are displayed in a grid format. At the bottom of the screen, there are icons for a camera, a magnifying glass, and a "Back" button.

Item	Status	X1	X2	Y1	Y2
0	OK	8	16	24	
1	OK	9	17	25	
2	OK	10	18	26	
3	NG	11	19	27	
4		12	20	28	
5		13	21	29	
6		14	22	30	
7		15	23	31	

## 5-4 Saving Data to the Sensor

Until you have saved your settings explicitly to the memory in the FQ Sensor, the settings are only stored temporarily. They will be lost if the power is turned OFF. Execute [Save data] after you have finished making your settings. The FQ Sensor will remind you to do so with a message if you switch from Setup Mode to Run Mode. You can use this feature to keep the previous settings and discard the new settings if desired, but keep in mind that all settings that are not saved explicitly are replaced by the settings that are stored in the memory of the FQ Sensor the next time you turn ON the FQ Sensor.

### Important



Do not turn the power supply OFF while data is being saved. The data that is being saved may become corrupted.

### ► [Test]

- 1 Press [Save data].
- 2 Press [Yes].



### Note

- Scene data and system data can be saved in this way.  
 Scene data and system data details: p. 83
- Measurement data and image data cannot be saved in this way.  
 Logging measurement data: p. 76
- Settings data can also be backed up to an external memory.  
 Saving settings: p. 83

# Operation

---

<b>6-1 Starting Operation</b> .....	<b>60</b>
<b>6-2 Configuring the Run Mode Display</b> .....	<b>62</b>
<b>6-3 Checking the Trend of Measurement Results with Graphs</b> .....	<b>64</b>
<b>6-4 If Scanning Fails</b> .....	<b>67</b>

# 6-1 Starting Operation

When test measurements and adjustments in Setup Mode have been finished, the display moves to Run Mode and actual measurements begin. In Run Mode, the Sensor operates stand-alone and outputs the measurement judgement results on the I/O lines accordingly to the settings. If the Touch Finder or the PC Tool is connected via network to the Sensor, the operation of the Sensor can be monitored in the following ways.

## Run Mode Display

The present display name.

Overall judgement

Measurement processing time  
The time taken from when an image is input until all measurements have been completed.

Inspection results can be displayed in six formats, such as in a list or as a trend graph. p. 62

These buttons are displayed both in Setup and Run Mode. p. 14

Selected inspection item

Connected Sensor name

Selected scene number

Sub-menu

Corrected position  
A red circle appears in a corrected position.

Tool Button or OK Button

## Moving to Run Mode

You can move from Setup Mode to Run Mode by using the following procedure.

- 1 Press [Run].**
- 2 Press [Switch to Run mode.].**
  
- 3 Press [Yes].**  
**If you press [No], the setting will not be saved and you will move to Run Mode.**

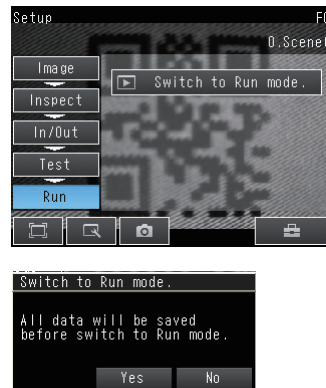

**Note**

- Returning to Setup Mode

Press  and press [Sensor settings].

- Signal Status When Moving to Run Mode

When moving to Run Mode, the signal will change as shown below and data can be input from and output to an external device.

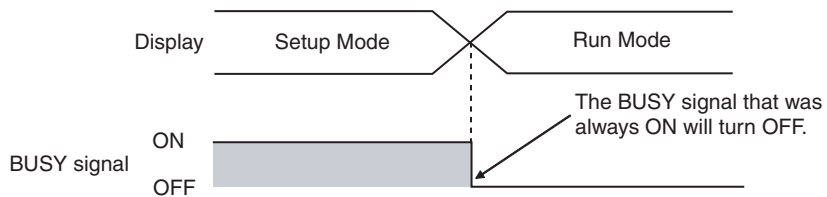

# 6-2 Configuring the Run Mode Display

There are six types of displays that can be used, as shown below. Select the display as desired.

### Checking the Judgement Results of Inspection Items

Graphics



The image and region currently being measured will appear.

Graphics + Details



In addition to [Graphics] display, individual judgement results and measurement values of selected inspection items will appear.

### Checking the Overall Judgement Result History

Statistical data



The currently measured image and history of the overall judgement results (measurement count, NG count, and NG rate) will appear.

### Checking the Judgements of All Inspection Items in a List

All results/region  
(Standard Models Only)



The judgement results of all inspection items can be checked in a list.

### Displaying Measurement Result Histories

Trend monitor

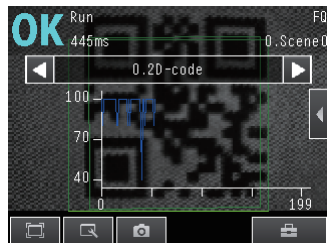

The statistical data for the currently selected inspection item can be checked against time.

p. 64

Histogram

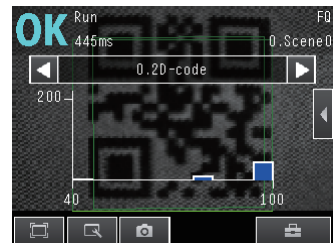

The distribution of measurement results of the currently selected inspection item can be checked.

p. 65

## (Run Mode) – [Select display]

The following displays are convenient if more than one Sensor is connected.

Multi sensor

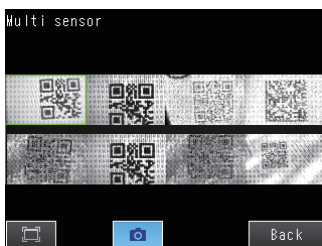

Displays the measurement results of all connected Sensors.  
Green display: OK, Red display: NG

NG sensor

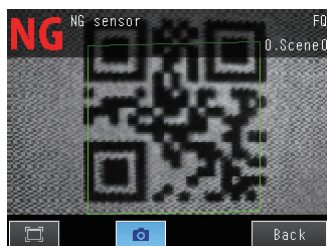

Automatically changes to the display for any Sensor with an NG result.

## (Run Mode) – [Sensor monitor]



## Specifying the Startup Run Mode Display

The display that appears when power supply is turned ON can be set.  
The default setting is [Graphics].

▶  (Setup Mode or Run Mode) – [TF settings] – [Startup display] – [Display pattern]

### Note

You can set the scene to be displayed when the power supply is turned ON.

 Setting the Startup Scene: p. 71

## Displaying the Inspection Item Results

You can scroll through the measurement results of all the configured inspection items by using the following operations.

Switches to the previous inspection item.

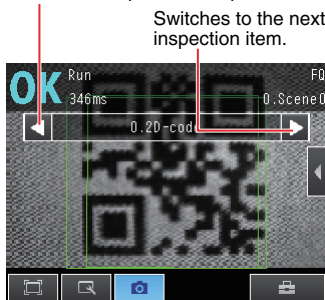

### Note

The following are also displayed in addition to the measurement results for each inspection item.

- Camera input: The image that is being measured is displayed.
- Filter: Shows the image after filter processing.

## 6-3 Checking the Trend of Measurement Results with Graphs

Measurement result histories can be checked using the trend monitor and histograms.

### Trend Monitor

Changes in the measurement values of the selected inspection item against time can be observed from the graph. It becomes possible to predict when malfunctions may occur or to analyze the cause of the malfunction by checking the trends in the measurement values. The most recent 1,000 measurement values are displayed on the graph.

#### • [Trend Monitor] Display

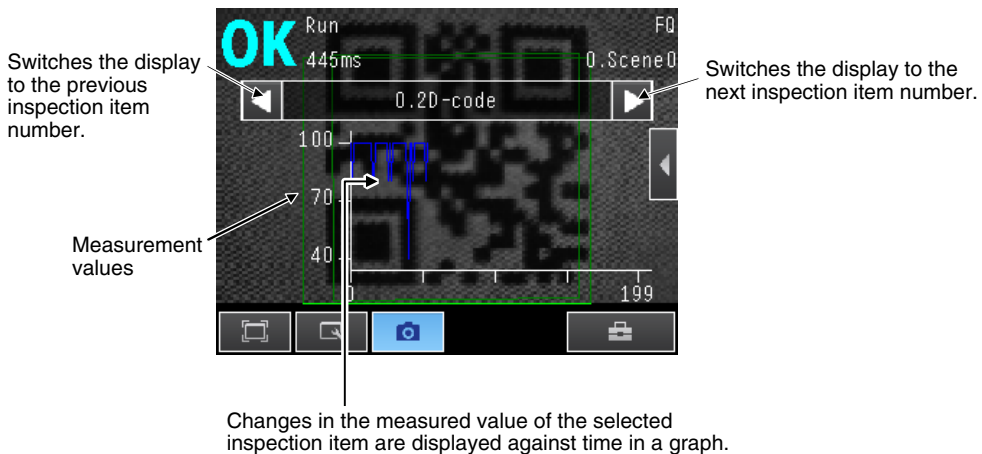

#### ► (Run Mode) – [Select display] – [Trend monitor]

### Arranging the Trend Monitor Display

The display range for the vertical axis and display conditions for the horizontal axis can be changed. However, the display range and the number of data settings are disabled when a display other than the trend monitor is displayed.

#### • Disabling Automatic Selection of the Display Range

- 1 Press [◀] – [Auto display] on the right of the trend monitor.
- 2 Press [OFF].

#### • Changing the Display Range of the Vertical Axis

- 1 Press [◀] – [Display range] on the right of the trend monitor.
- 2 Set the minimum and maximum values of the measurement values.

#### • Changing the Number of Values That Are Displayed

- 1 Press [◀] – [Number of data] on the right of the trend monitor.
- 2 Select the number of values from 200, 400, and 1,000.

## Note

- Trend monitor data is held until the power supply is turned OFF.
- You can select whether to display all data on the trend monitor or only data for which the overall judgement is NG. Logging settings are applied to the trend monitor as well. However, they are not applied to trend monitor when it is displayed in Setup Mode.

 Check recent measurement trends (recent results logging): p. 79

## Histograms

The distribution of each measurement value can be checked on a histogram. The most recent 1,000 measurement values are displayed on a graph.

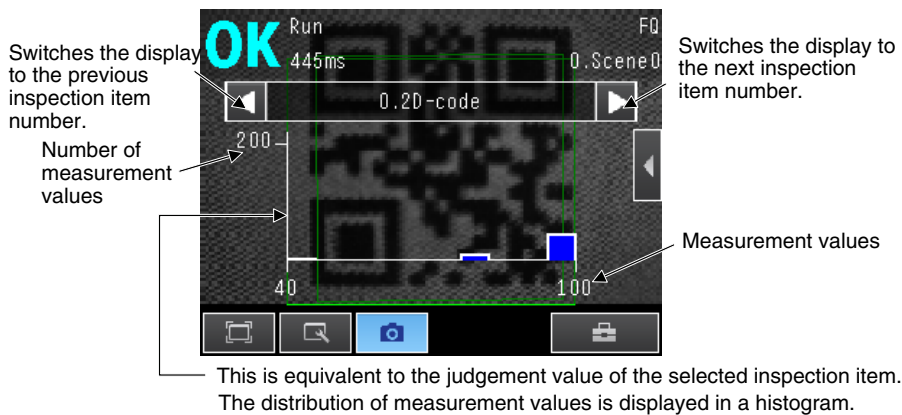

▶  (Run Mode) – [Select display] – [Histogram]

### Arranging Histogram Display

The display range on the horizontal axis and the number of data on the vertical axis of the histogram can be changed.

#### • Disabling Automatic Adjustment of the Display Range

- 1 Press [◀] – [Auto display] on the right of the histogram.
- 2 Press [OFF].

#### • Changing the Display Range of the Horizontal Axis

- 1 Press [◀] – [Display range] on the right of the histogram.
- 2 Select the maximum measurement value, the minimum measurement value, and the class.

#### • Changing the Number of Data on the Vertical Axis

- 1 Press [◀] – [Number of data] on the right of the histogram.
- 2 Select the maximum number of data to display.

**Note**

---

- Histogram data is held until the power supply is turned OFF.
- You can select whether to display all data in the histogram or only data for which the overall judgement is NG. Logging settings are applied to the histogram as well. However, they are not applied to histograms displayed in Setup Mode.



Check recent measurement trends (recent results logging): p. 79

---

# 6-4 If Scanning Fails

If the 2D code is not successfully scanned, an NG scanning result will appear in the "Characters" field of the detailed result display. Refer to the table below for the appropriate action to take for the NG scanning result.



NG scanning result	Action
?E000	The background may not be uniform; unable to find the 2D code. Check the surface of the work and lighting conditions.
?E100	Unable to recognize the cells of the 2D code. Check the marking and lighting conditions, and repeat teaching.
?E200	Unable to scan within the set time. Check the surface of the work and lighting conditions, and repeat teaching. Set a larger inspection timeout value.
?E300	Unable to recognize the 2D code because there were too many 2D codes in the inspection region. Make the inspection region smaller.

MEMO

# Convenient Functions

---

7-1 Changing the Scene to Change the Line Process .....	70
7-2 Display Functions .....	72
7-3 Monitoring the Signal I/O Status.....	75
7-4 Logging Measurement Data and Image Data .....	76
7-5 Saving Sensor Settings .....	83
7-6 SD Card Operations .....	84
7-7 Convenient Functions for Operation.....	86
7-8 Convenient Functions for Setup.....	88
7-9 Functions Related to the System .....	89
7-10 Setting the Retry Function .....	91

# 7-1 Changing the Scene to Change the Line Process

## What Are Scenes?

With an FQ Sensor, the inspection items that can be processed at the same time are registered as scenes. A command input from an external device or a touch panel operation can be used to select a certain scene. If a scene is registered for each type of measurement object or inspection, the line process can be changed simply by changing the scene when the measurement object or inspection changes. A maximum of 32 screens can be created.

Example:

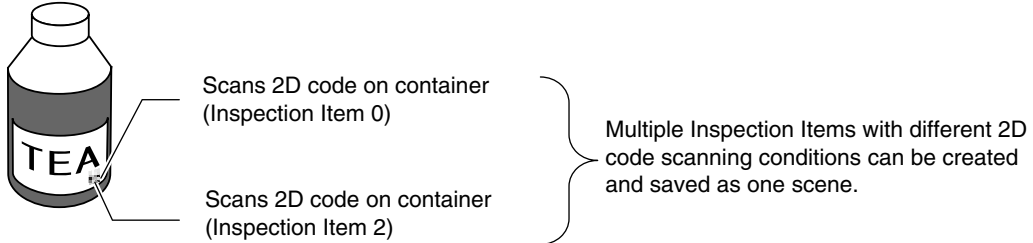

Line Process Changes:

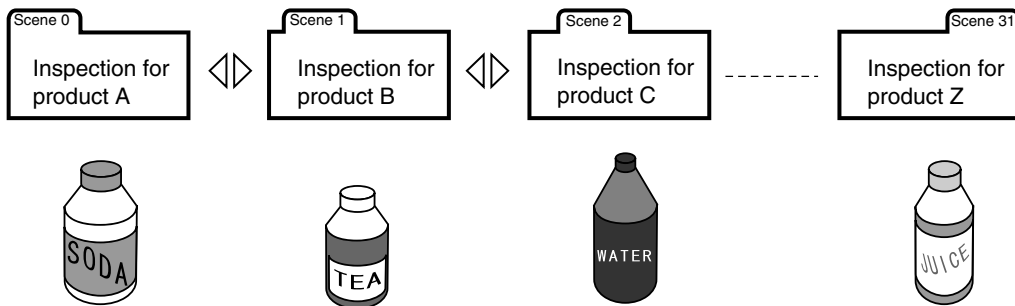

### • Settings Included with Scenes

The following settings are changed when the scene is changed: Camera image ([Image] Tab Page) and Inspection Items ([Inspect] Tab Page). The settings related to external I/O specifications that are included in the output settings and the system settings for the overall Sensor are used for all of the scenes.

Refer to the following information for the data that is included in the scene data.

10-1 Menu Tables: p. 158



## Creating New Scenes

The default scene number is 0. To create another scene, use the following procedure to switch the scene and then make the settings.

### ▶ (Setup Mode) – [Select scene]

- 1 Press the number of the scene to change to and then press [Select].
- 2 The scene will change. Make the settings for the scene.

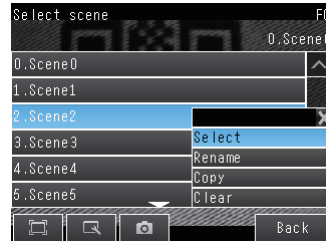



## Changing Scene Names, Copying Scenes, and Deleting Scenes

### ▶ (Setup Mode) – [Select scene]

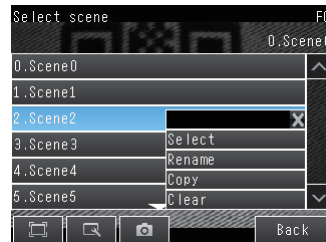
- 1 Press the number of the scene and then press [Rename], [Copy], or [Clear].
- 2 To change the name, enter a new scene name in 15 alphanumeric characters or less.  
To copy a scene, press the number of the scene to copy.



## Switching Scenes from an External Device

- Controlling with Parallel Inputs
  -  Changing the Scene: p. 107
- Controlling with Ethernet Inputs
  -  Command Details: p. 127

## Setting the Startup Scene

### ▶ (Setup Mode) – [Sensor settings] – [Startup settings]

The following items can be set.

Item	Purpose	Setting range
Startup mode	Select whether the startup scene number is set manually.	ON OFF (The scene number when the settings were saved will be the startup scene number. The startup mode is set to OFF in the default settings.)
Startup scene	Set the scene number to use at startup.	Standard models: 0 to 31, Single-function models: 0 to 8, Default: 0

# 7-2 Display Functions

The procedures given in this section can be used to make the Sensor easier to use and the display easier to see.

## Image Zoom

The display can be zoomed in or out to make the image easier to see.

### ▶ (Setup Mode or Run Mode)



- Enlarges the display.
- Reduces the display.
- Fits the image to the display size.

Press [Back] to end setting the display.

## Displaying a Live Image

You can display a live image to check the image that is input by the Sensor in realtime.

### ▶ (Setup Mode)

- 1 Press .
- 2 Press [Camera].
- 3 Press [Live].
- 4 Press the [Back] Button to return to the [Display] Display.

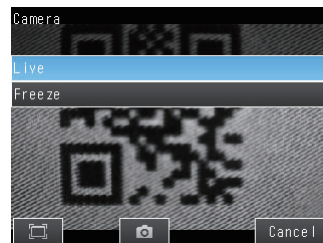

## Displaying a Frozen Image

You can display a frozen image to stop image refreshing and display the last image that was input.

### ▶ (Setup Mode)

- 1 Press .
- 2 Press [Camera].
- 3 Press [Freeze].
- 4 Press the [Back] Button to return to the [Display] Display.

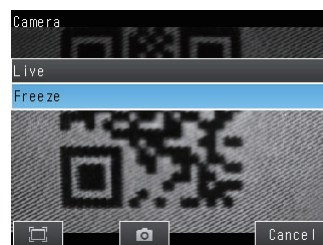

## Displaying a Saved Image

You can display an image that was saved in internal memory in the Sensor or in an SD card. This can be done to configure inspection items or to check measurements using saved images.

### ▶ (Setup Mode)

- 1 Press .
- 2 Images in the Sensor's built-in memory: Press [Log].  
Images on the SD card: Press [File].
- 3 Press the [Back] Button to return to the [Display] Display.



#### Note

Refer to the following information for the procedures to save images.

 Logging Measurement Data: p. 76

## Updating the Display and Measurement Results Only for NG Measurement Results

In Run Mode, you can specify updating the display of the image and measurement results only when the measurement result is NG.

### ▶ (Run Mode)

- 1 Press .
- 2 Press [Last NG image].
- 3 Press [Back].



Change the following setting to display the last NG image after restarting.

### ▶ (Setup Mode or Run Mode) - [TF Settings] - [Startup display] - [Display update mode]

- 1 Press [Last NG image].

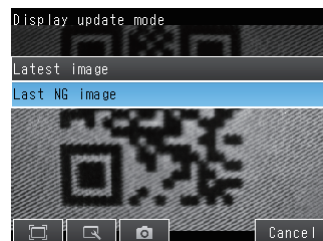

#### Note

If an operation to change the display is performed (e.g., if the display pattern is changed or the inspection item is changed) when displaying images for NG results is set, the display will change to refreshing the most recent measurement results and the most recent NG display will disappear.  
To ensure that you can check the NG results, log the NG results.



Checking Recent Measurement Trends (Recent Results Logging): p. 79

## Automatically Changing to the Display for Any Sensor with an NG Result

You can change the settings to automatically display the Sensor for which the measurement result is NG if more than one Sensor is connected.

▶  (Run Mode) – [Sensor monitor] – [NG Sensor]

## Hiding the Menu

You can hide the menu and display only the image on the Touch Finder or PC Tool to check the part of the image hidden behind the menu.

If you press the icon again, the menu will be displayed.

▶  (Setup Mode or Run Mode)

## Turning ON/OFF the Touch Finder Backlight

You can use Eco Mode to turn OFF the LCD backlight and reduce the power consumed by the Touch Finder whenever there is no operation on the Touch Finder for 30 seconds or longer. The LCD backlight will turn ON whenever any part of the touch panel is pressed.

▶  (Setup Mode or Run Mode) – [TF settings] – [LCD Backlight] – [ECO mode]

## Changing the Brightness of the Touch Finder

The brightness of the LCD backlight can be changed to any of five levels.

▶  (Setup Mode or Run Mode) – [TF settings] – [LCD Backlight] – [Brightness]

# 7-3 Monitoring the Signal I/O Status

You can check if the I/O connections are working normally.

► [In/Out] – [I/O monitor] – [I/O Monitor]

- 1** The I/O status of the external devices will be displayed.
- 2** Press the [OK] Button to return to the [I/O monitor] Display.

Input Signals (TRIG and IN0 to IN5)  
Signals that are displayed in red are currently being input from the external devices to the Sensor.

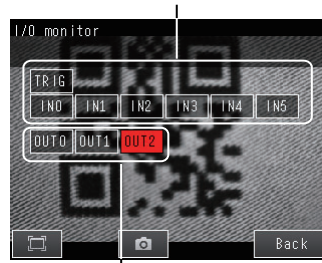

Output Signals

(OUT0, OUT1, and OUT2)

Signals that are displayed in red are currently being output from the Sensor to the external devices.

You can turn the signals ON and OFF by pressing them to test the outputs.

# 7-4 Logging Measurement Data and Image Data

There are two ways to log data. Data can be temporarily saved in memory inside the Sensor (called recent results logging) or large amounts of data can be saved in SD cards or other external media (called file logging). The amounts of data that can be logged are given in the following table.

Logged data	Recent results logging	File logging
Measurement data (Measured values)	1,000 measurement values max.	Up to the capacity of the external memory
Image data (Measured values)	20 images max.	

## Logging All Data (File Logging)

Large amounts of measurement and image data can be saved in files in external memory (SD cards or computer).

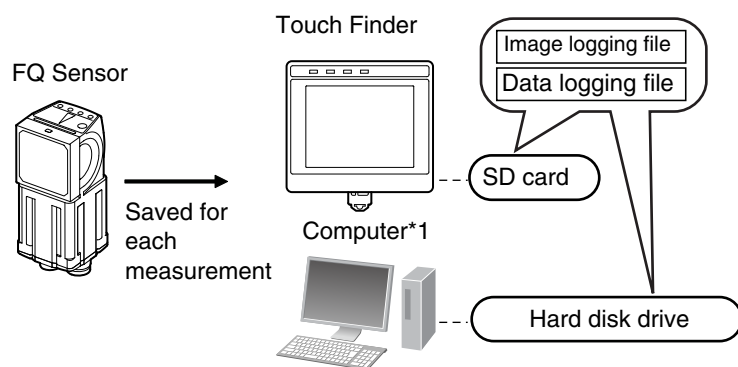

\*1: Image data and measurement data can be logged in the same way as for the Touch Finder by installing the PC Tool for FQ.

System Configuration: p. 18

### Note

Only the data for the Sensor that is currently being displayed will be logged even if more than one Sensor is connected.

If multiple sensors are displayed, or if the most recent NG sensor is displayed, only the results of the sensor that was displayed before changing to the other sensor monitor screen will continue to be logged. Simultaneous logging of the results of multiple sensors is not possible.

## Setting the Data To Be Logged

You can select the data to be logged.

### ► [In/Out] – [Log setting]

- 1 Press the data for which to change the logging parameter.
- 2 Change the logging parameter and then press [Back].

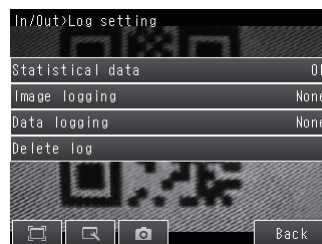

Item	Description
Image logging	<ul style="list-style-type: none"> <li>All: All images will be logged regardless of the measurement results.</li> <li>Only NG: Only images for which the overall judgement was NG will be logged.</li> <li>None: No images will be logged (default).</li> </ul>
Data logging	<ul style="list-style-type: none"> <li>All: All measurement data (Measured values) will be logged regardless of the measurement results.</li> <li>Only NG: Only measurement data (Measured values) for which the overall judgement was NG will be logged.</li> <li>None: No measurement data (Measured values) will be logged (default).</li> </ul>

**Note**

The logging parameter settings are the same for file logging and recent results logging.

## Starting and Stopping Logging

After logging is started (i.e., set to ON), the specified image data and measurement data will be saved in the SD card or computer hard disk each time measurements are performed.

### ▶ (Run Mode)

- 1 Press [Logging].
- 2 Press [Image logging] or [Data logging].
- 3 Press [ON] to start logging.  
Press [OFF] to stop logging.
- 4 Press [Back].

## Saved Log Data

### • Storage Locations and File Names for Logged File Data

Data	Storage location	File name
Image logging	\sensor_name\ LOGIMAGE\number <sup>*1, *2</sup>	YYYY_MM_DD-HH_MM_SS.IFZ Example: The following name would be used for measurements performed at 10:10:21 pm on March 10, 2010. 2010_03_10-22_10_21.IFZ
Data logging	\sensor_name\LOGDATA <sup>*2</sup>	YYYY_MM_DD-HH_MM_SS.CSV Example: The following name would be used for measurements performed at 10:10:21 pm on March 10, 2010. 2010_03_10-22_10_21.CSV

\*1: A five-digit number is assigned as a name to the image data storage folder in the order of folder creation as shown below.

Up to 100 images are stored in each folder.

```
00000
00001
⋮
```

\*2: Files are stored in the following folder when the PC Tool is used.

\My Documents\OMRON FQ\ SDCard

### • File format

Image logging: Image data is saved in a special format for OMRON Sensors. (The file name extension is IFZ.)

Data logging: Measurement data is saved in the following CSV format.

<Date\*1>,<Time\*1>,<Measurement value for inspection item 0>,<Measurement value for inspection item 1>,<...>,<Measurement value for inspection item 31>,<Delimiter

↑  
Field separator

↑  
Record separator

\*1: The date is given in the following format: 2010/6/1 (for June 1, 2010). The time is given in the following format: 12:01:20 (for 12:01 and 20 seconds pm).

## Changing the File Format

The output CSV file format can be changed according to the external device.

Item	Symbol
Field separator	None, comma (default), tab, space, or semicolon
Decimal symbol	None, point (default), or comma
Record separator	None, comma, tab, space, or CR or CF+LF (default)

Use the following menu command to change the output CSV file format.

▶  (Setup Mode or Run Mode) – [TF settings] – [File format]

## Ensuring That All Measurement Results Are Logged in External Memory

To ensure that all measurement results are actually saved, change the settings so that the BUSY signal remains ON until logging has been completed. During operation, do not input the next trigger until the BUSY signal turns OFF.

▶ [In/Out] – [I/O setting] – [I/O terminals] – [Output] Tab Page – [BUSY output]

Change the BUSY output parameter to [Data logging].

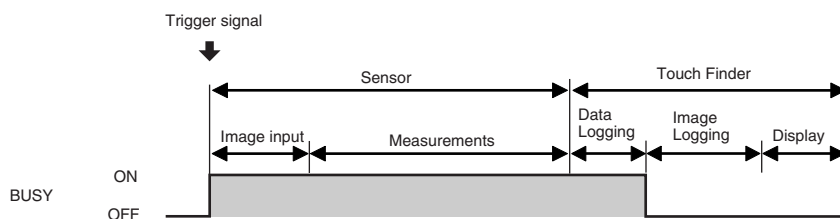

### Note

- File logging cannot be used when performing continuous measurements.
- If you use the PC Tool, the logging time may vary by up to 100 ms depending on the application conditions of your computer.
- If logging data to an SD card, the write time varies depending on the amount of the available space on the SD card.

Reference value: For SDHC class 4, the time required to write image data is approx. 200 to 800 ms.



## Checking Recent Measurement Trends (Recent Results Logging)

The most recent measurement results can be logged inside the Sensor.

Even if data is not logged in external memory, such as an SD card, trends in measurement results can be easily checked on the Touch Finder.

However, if the power supply is turned OFF or the scene is changed, this data will be lost.

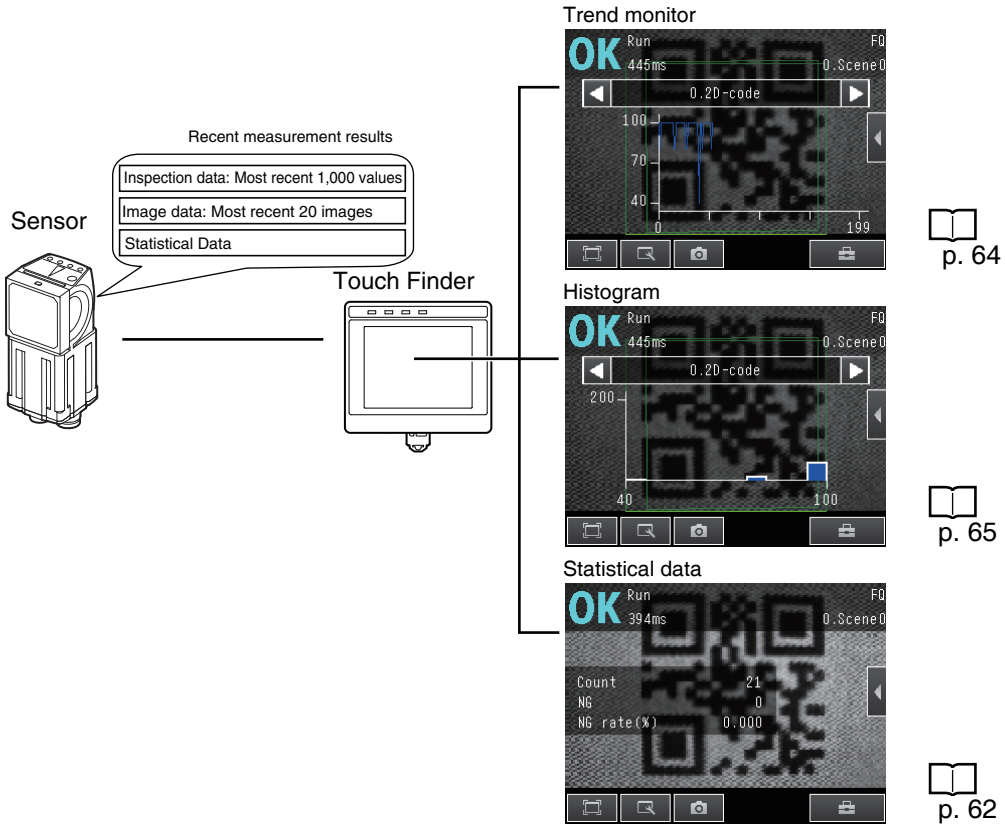



## Setting the Data To Be Logged

Use the following procedure to set the statistical data, image data, and measurement data that will be logged.

### ► [In/Out] – [Log setting]

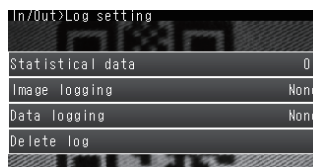
- 1 Press the data for which to change the logging parameters.
- 2 Change the logging parameter and then press [Back].



Item	Description
Statistical Data	Statistical data, such as the number of measurements, the number of NG overall judgements, and the NG rate, since the power supply was turned ON will be logged. <ul style="list-style-type: none"><li>• ON: Statistical data will be displayed (default).</li><li>• OFF: Statistical data will not be displayed.</li></ul>
Image logging	These are the same as for file logging.
Data logging	 Logging All Data (File Logging): p. 76

#### Note

The logging parameters for image data and measurement data are the same as those for file logging.

## Starting Logging

Logging will be started as soon as the data to be logged has been set.

If the settings are saved, logging will start automatically the next time the power supply is turned ON.

## Checking the Results of Logging

The results of logging can be checked using the trend monitors, histograms, or statistical data.

 p. 62

Use the following menu command to check the measurement images.

-  (Setup Mode) –  – [Log]

## Deleting Logged Data

The logged data will be deleted when the power supply to the Sensor is turned OFF or the scene is changed. The logged data can also be deleted without turning OFF the power supply.

### • Setup Mode

#### ► [In/Out] – [Log setting]

- 1 Press [Delete Log].

## Saving Logged Recent Results Data in a File

Although the logged recent results data will be deleted when the power supply is turned OFF, it can be saved in a file in external memory.

The most recent 1,000 measurement values and the most recent 20 images will be saved.

►  (Setup Mode) – [Save to file] – [Logging] Tab Page

**1** Press the data to save.

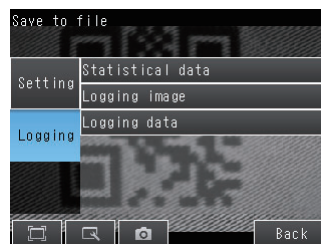

**2** The following display will appear if [Logging image] is pressed.

Select whether to save the most recently logged image or to save all of the data that is logged in the Sensor.



The file storage locations and file format are given in the following table.

Item	Storage location	File name
Statistical data	\\sensor_name\LOGDATA* <sup>1</sup>	YYYY_MM_DD-HH_MM_SS.CSV Example: The following name would be used for files saved at 10:10:21 pm on March 10, 2010. 2010_03_10-22_10_21.CSV
Logging data		
Logging image	\\sensor_name\LOGIMAGE* <sup>1</sup>	YYYY_MM_DD-HH_MM_NNN.IFZ Example: The following name would be used for files saved at 10:10:21 pm on March 10, 2010. 2010_03_10-22_10_21_000.IFZ "NNN" is a serial number that is added when images are logged at the same time.

\* Files are stored in the following folder when the PC Tool is used.

\\My Documents\OMRON FQ\ SDCard

### • File format

Statistical data: The data is saved in the following CSV format.

Number of measurements, number of OKs, number of NGs, OK rate, NG rate (delimiter)

Logging image: Image data is saved in a special format for OMRON Sensors.

(The file name extension is IFZ.)

Logging data: Measurement data is saved in the following CSV format.

<Data number\*1>,<Measurement value for inspection item 0>,<Measurement value for inspection item 1>,...,<Measurement value for inspection item 31>,<Delimiter>

↑  
Field separator

↑  
Record separator

\*1: Data number 1 is always the data for the oldest measurement and data number 1,000 is always the most recent.

### Note

- The saved recent measurement data cannot be loaded back into the Sensor and displayed on a trend monitor or histogram.
- The data and time are not recorded with the measurement data.
- The file name is created from the time when the file is saved. It does not indicate when the measurement was made.
- The recent log data will be cleared if the scene is changed.

## Changing the File Format

---

The output CSV file format can be changed as shown below according to the external device.

 Changing the File Format: p. 78

# 7-5 Saving Sensor Settings

The Sensor settings are saved in flash memory inside the Sensor.

This section describes how to back up the settings in and restore them from an SD card or other external memory.

## Backing Up Settings in External Memory

▶  (Setup Mode) – [Save to file] – [Setting] Tab Page

- 1 Press the data to save.
- 2 Enter the file name in 15 characters or less.  
After entering the file name, press [OK]. The data will be saved and the display will return to [Save to file].

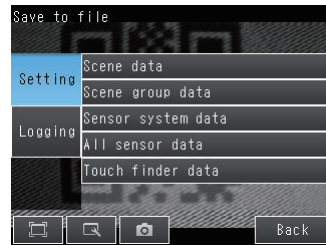

### Applicable Data

Data	Storage location	Description
Scene data (The file name extension is SCN.)	\sensor_name\SCN	The following data is backed up for each scene. <ul style="list-style-type: none"> <li>• Settings for all inspection items</li> <li>• Order of inspection items</li> </ul>
Scene group data (The file name extension is SGP.)	\sensor_name\SGP	All scene data is backed up.
Sensor system data (The file name extension is SYD.)	\sensor_name\SYD	All system data in the Sensor is backed up. The system data is the same for all scenes.
All Sensor data (The file name extension is BKD.)	\sensor_name\BKD	All settings in the Sensor (all scene data and Sensor system data) is backed up.
Touch Finder data (The file name extension is MSD.)	\MSD	All settings in the Touch Finder are backed up.

For the PC Tool, data will be saved in the following folder: \\.\My Documents\OMRON FQ

## Restoring Data to the Sensor from External Memory

▶  (Setup Mode) – [Load from file]

- 1 Press the data to be restored.
- 2 The selected data will be read from external memory and displayed.  
Press the file to load.

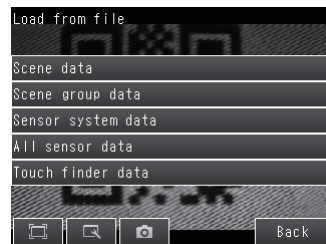

# 7-6 SD Card Operations

With an FQ Sensor, the following folders are automatically created in the SD card according to the data that is saved. The specified data is saved in files in these folders.

Storage folder*1	Data
\sensor_name\SCN	Scene data (The file name extension is SCN.)
\sensor_name\SGP	Scene group data (The file name extension is SGP.)
\sensor_name\SYD	Sensor system data (The file name extension is SYD.)
\sensor_name\BKD	All sensor data (The file name extension is BKD.)
\MSD	Touch Finder data (The file name extension is MSD.)
\sensor_name\LOGIMAGE	Image data (The file name extension is IFZ.)
\sensor_name\LOGDATA	Statistical data and measurement data (The file name extension is CSV.)
\CAPTURE	Captured images (The file name extension is BMP.)

\*1: For the PC Tool, data will be saved in the following folder: \\.\My Documents\OMRON FQ

**Note**

The PC Tool does not support SD card operations.

## Inserting and Removing SD Cards

### Inserting an SD Card in the Touch Finder

- 1** Open the cover to the SD card slot on the top of the Touch Finder.
- 2** Insert the SD card with the back of the SD card facing the front of the Touch Finder and press it in until it clicks into place.
- 3** Close the cover to the SD card slot.

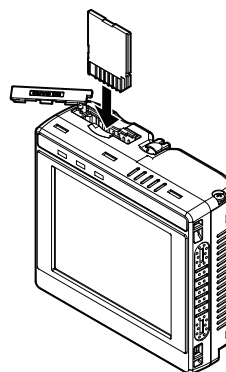
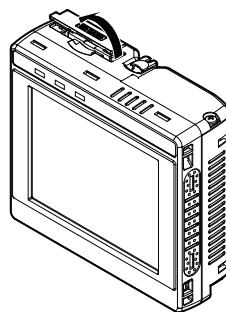

## Removing an SD Card from the Touch Finder

- 1 Open the cover to the SD card slot on the top of the Touch Finder.
- 2 Press in on the SD card until you hear a click.
- 3 Pull out the SD card.
- 4 Close the cover to the SD card slot.

- Never remove the SD card while data is being saved or read. The data on the SD card may be corrupted.

### Important

Do not restart or turn OFF the power supply to the Sensor or Touch Finder while a message is being displayed saying that data is being saved to or read from the SD card. The settings or system data may be corrupted.

## Checking the Available Space on the SD Card

Before saving data to the SD card, use the following display to make sure that there is sufficient space available on the SD card.

- ▶  (Setup Mode or Run Mode) – [TF settings] – [SD card] – [SD card information]

The following information in the SD card inserted in the Touch Finder can be checked.



## Formatting an SD Card

- ▶  (Setup Mode or Run Mode) – [TF settings] – [SD card] – [Format]

Press [Yes] to start formatting.

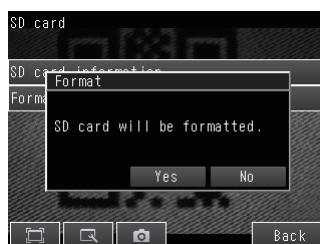

# 7-7 Convenient Functions for Operation

This section describes the functions that can be used during Sensor operation.

## Setting a Password to Prevent Unwanted Changes

A password can be set to prevent unwanted changes to settings.

If a password is set, you cannot change from Run Mode to Setup Mode without entering the password.

### Setting a Password

▶  (Setup Mode) – [Sensor settings] – [Password settings]

- 1 Press [Password on/off] and press [ON].
- 2 Press [Enter password].
- 3 Enter a password containing up to 15 characters and press [OK].

### Clearing the Password

▶  (Setup Mode) – [Sensor settings] – [Password settings]

Press [Password on/off] and press [OFF].

### Entering the password when switching from [Run] Mode to [Setup] Mode.

- 1 If a password is set and you try to change from Run Mode to Setup Mode, the following password entry display will appear.

▶  (Setup Mode) – [Sensor settings]

- 2 Press the text box. A keyboard display will appear. Enter the password and press [OK]. If the password is correct, the Setup Mode will be displayed.

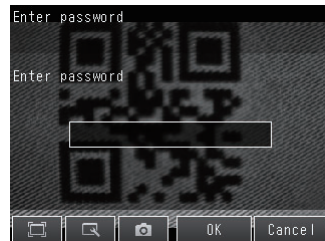

#### Important

- This password restricts only the operation to switch from Run Mode to Setup Mode. It does not restrict other operations.
- If you forget the password, contact your OMRON representative for the procedure to clear the password.
- The password is deleted when the Sensor is initialized.



## Capturing the Displayed Image

The current display on the Touch Finder or PC Tool can be captured and used in text files and other files on the computer.

The captured images are saved in external memory\*1 as bit maps.

\*1: Images captured on the Touch Finder are saved in the SD card. Images captured with the PC Tool are saved in the computer's hard disk drive.

### ▶ (Setup Mode or Run Mode)

The image that is being displayed when the button is pressed is saved in external memory.

#### • Storage Location and File Names

Storage location	File name
\\CAPTURE	YYYY_MM_DD-HH_MM_SS_MS.BMP Example: The following name would be used for an image that was captured at 10:10:21.350 pm on March 10, 2010. 2010_03_10-22_10_21_350.BMP

#### Important

Make sure an SD card is inserted in the Touch Finder before capturing display images.

#### Note

For the PC Tool, data will be saved in the following folder: \\..My Documents\OMRON FQ

# 7-8 Convenient Functions for Setup

This section describes the functions that can be used when setting inspection items.

## Making Settings with Stored Images

With an FQ Sensor, judgement parameters can be set by using the following images.

- Images saved in internal Sensor memory
- Image files in an SD card

## Saving Image Data

### • Temporarily Saving Images in the Sensor

The measured images can be temporarily saved inside the Sensor. These images are held until the Sensor power supply is turned OFF.

▶ **[In/Out]** – **[Log setting]** – **[Image logging]**

 Setting Logging Parameters for Image Data: p. 79

### • Saving Images in the Sensor to an SD Card

The images that are temporarily saved inside the Sensor can be saved to an SD card.

▶  **(Setup Mode)** – **[Save to file]** – **[Logging] Tab Page**

**1** Press **[Logging image]**.

**2** Select whether to save the most recently logged image or to save all of the data that is logged in the Sensor.

Storage location	File name
\\sensor_name\LOGIMAGE	YYYY_MM_DD-HH_MM_SS.IFZ Example: The following name would be used for files saved at 10:10:21 pm on March 10, 2010. 2010_03_10-22_10_21.IFZ

### • Saving Images in an SD Card

The image data can be saved in the SD card each time measurements are performed.

▶  **(Run Mode)** – **[Logging]**

 Logging All Data (File Logging): p. 76

## Displaying Image Data

### • Images Saved in Internal Sensor Memory

▶  **(Setup Mode)** –  – **[Log]**

### • Image Files in a SD Card

▶  **(Setup Mode)** –  – **[File]**

 Arranging the Display - Displaying a Saved Image: p. 73

# 7-9 Functions Related to the System

This section describes system settings.

## Turning OFF the Integrated Sensor Lighting

The internal light can be turned OFF to use external illumination.

▶ **[Image]** – **[Camera setup]** – [**◀**] – **[Lighting control]**

Press **[OFF]**.

## Switching the Display Language

Any of the following languages can be selected for display on the Touch Panel or PC Tool.

Japanese, English, German, French, Italian, Spanish, Traditional Chinese, Simplified Chinese, or Korean

▶  **(Setup Mode or Run Mode)** – **[TF settings]** – **[Language]**

Press the language to be displayed.

## Setting the Time on the Touch Finder

You can set the date and time.

▶  **(Setup Mode or Run Mode)** – **[TF settings]** – **[Time settings]**

## Initializing the Sensor and Touch Finder

### • Initializing the Sensor

▶  **(Setup Mode)** – **[Sensor settings]** – **[Initialize]**

### • Initializing the Touch Finder

▶  **(Setup Mode or Run Mode)** – **[TF settings]** – **[Initialize]**

## Restarting the Sensor and Touch Finder

### • Restarting the Sensor

▶  **(Setup Mode)** – **[Sensor settings]** – **[Restart]**

### • Restarting the Touch Finder

▶  **(Setup Mode or Run Mode)** – **[TF settings]** – **[Restart]**

## Checking Versions

### • Checking the Sensor Version

▶  (Setup Mode) – [Sensor settings] – [Information]

### • Checking the Touch Finder Version

▶  (Setup Mode or Run Mode) – [TF settings] – [Information]

## Checking the Touch Finder Battery Level

▶  (Setup Mode or Run Mode) – [TF settings] – [Battery level]

### Important

- The battery level is displayed only for a Touch Finder with a DC/AC/battery power supply (FQ-D31).
- The settings will be lost if the battery runs out while you are making the settings. If the battery level is low, save the settings and charge the battery immediately.

## Changing the Sensor Name

An alphanumeric name can be assigned to a Sensor to make it easier to recognize. This is convenient when more than one Sensor is connected.

▶  (Setup Mode) – [Sensor settings] – [Information] – [◀] – [Rename]

## Checking Available Memory in the Sensor

If a setting cannot be made, check the amount of memory that is available in the Sensor.

▶  (Setup Mode) – [Sensor settings] – [Information] – [◀] – [Memory State]

## Correcting the Touch Screen Positions of the Touch Finder

Use this function to correct the touch screen positions if they are offset from the opposite position.

▶  (Setup Mode) – [TF settings] – [Touch screen calib]

## Setting the Resolution of Measurement Objects Displayed on the PC Tool

Use this function to set the resolution of measurement object that are displayed on the Touch Finder on the PC.

▶  (Run Mode) – [TF settings] – [Resolution]

## Setting the Inspection Timeout Time

The time after which inspection times out can be set (msec).

▶  (Run Mode) – [Sensor settings] – [Timeout]

# 7-10 Setting the Retry Function

## Retry Function

At one inspection trigger, this function repeats scanning until the entire code is successfully scanned. The retry function has four modes: normal retry, exposure retry (\*1), scene retry, and trigger retry.

\*1: The brightness (exposure) depends on the shutter speed and gain. When HDR is ON, the shutter speed and gain are automatically adjusted for the optimum exposure. When HDR is OFF, the gain is fixed.

▶  (Setup Mode) – [Sensor settings] – [Retry details] – [Retry mode]

**1** Select the retry mode.

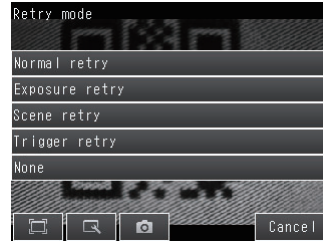

Retry mode	Description
Normal retry	Scanning is repeated the specified number of times at the specified interval until the entire code is successfully scanned. The maximum count and interval are set. The settings are configured in the retry settings of each scene.
Exposure retry	Scanning is repeated the specified number of times while varying the exposure (when HDR is OFF, the shutter time is varied) until the entire code is successfully scanned. The brightness step (shutter speed step when HDR is OFF), increment count, and decrement count are specified. The settings are configured in the retry settings of each scene.
Scene retry	Scanning is repeated the specified number of times while switching the scene until the entire code is successfully scanned. [Auto] or [Fixed] is selected for the switch order. [Auto]: Automatically decides the switch order based on the scanning success rate. [Fixed]: Switches scenes in the set order.
Trigger retry	When the trigger signal is ON, scanning is repeated until the entire code is successfully scanned. To use trigger retry, the I/O input mode must be set to expanded mode.
None (default)	Retry is not performed.

### Combining retry modes

Normal retry, exposure (shutter speed) retry, scene retry, and trigger retry cannot be used at the same time.

When scene retry is ON, the normal retry and exposure retry modes in the same scene are OFF.

When normal retry, exposure retry, or scene retry is ON, trigger retry is OFF.

## Setting normal retry

- Set the retry mode to [Normal retry] in "Retry details".

▶  (Setup Mode) – [Sensor settings] – [Retry details]

- 1 Press [Normal retry] for the retry mode.
- 2 Press OK.

- Specify the maximum count and interval.

▶ [Inspect] – [Retry details]

- 1 Set the maximum count and interval.



Parameter	Settings	Description
Max count	0 to 20, (default: 4)	Sets the maximum number of retries.
Interval	32 to 999, (default: 100)	Sets the capture interval (msec).

## Setting exposure retry

- Set the retry mode to [Exposure retry] in "Retry details".

▶  (Setup Mode) – [Sensor settings] – [Retry details]

- 1 Press [Exposure retry] for the retry mode.

- Set the brightness (shutter speed) step, increment count, and decrement count.

▶ [Inspect] – [Retry details]

- 1 Set the shutter speed step, increment count, and decrement count.

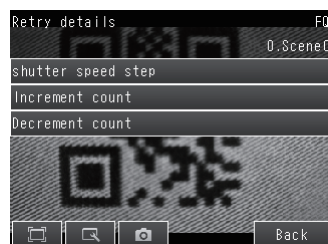

Parameter	Settings	Description
Brightness (shutter speed) step	Brightness: 1 to 20, default: 2 Shutter speed: 0.01 to 1.00 (default: 1.00)	Sets the brightness or shutter speed step (msec).
Increment count	0 to 10 (default: 2)	Sets the brightness (shutter speed) increment count.
Decrement count	0 to 10 (default: 2)	Sets the brightness (shutter speed) decrement count.

## Setting scene retry

- Set the retry mode to [Scene retry] in "Retry details".

▶  (Setup Mode) – [Sensor settings] – [Retry details]

- 1 Press [Scene retry] for the retry mode.
- 2 Set the switch order.
- 3 Set the scenes that are switched through.



Parameter	Settings	Description
Switch Order	Auto (default), Fixed	Sets the scene switching order. Auto: Switches through the scenes in the order of highest frequency of use. Fixed: Switches through the scenes in the order that the scenes were registered for scene switching.
Retry scene	1st to 32nd	Register the scenes for scene switching. Register the scenes to switch in order from "1st". If there are any scenes for scene switching that are not registered, the remaining scenes are ignored.

## Auto scanning order

The scanning procedure when the sort order is set to auto is shown below.

1st : The immediately previous scene that scanned successfully

2nd and following: Order of largest number of successful scans

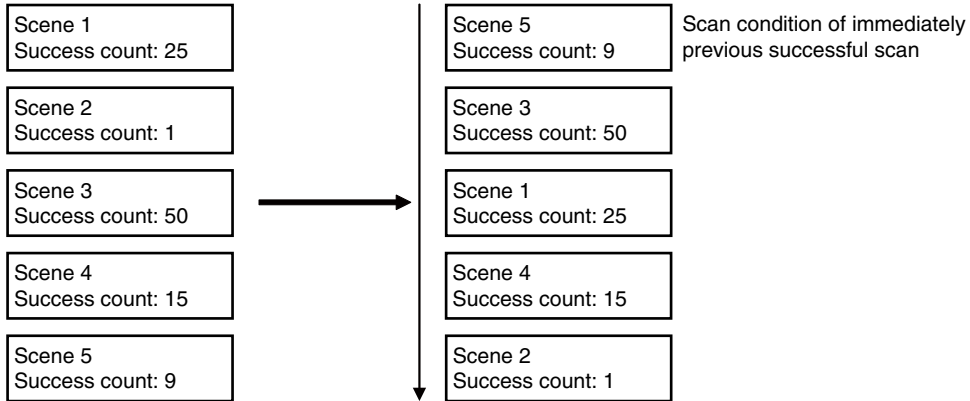

- In the default state, the order is the order of the scene numbers.
- If the power is interrupted or the sensor is restarted, the success counts are initialized when adjust mode is entered.

## Setting trigger retry

- Set the retry mode to [Trigger retry] in "Retry details".

▶  (Setup Mode) – [Sensor settings] – [Retry details]

**1** Press [Trigger retry] for the retry mode.

### Important

To use trigger retry, the I/O input mode must be set to expanded mode.

▶ [In/Out] – [I/O setting] – [I/O terminals] – [Input] tab – [Input mode]  
Press "Expanded mode".



# Communications with External Devices

---

8-1 Controlling/Outputting in Parallel .....	96
8-2 Outputting/Controlling with Ethernet .....	118

# 8-1 Controlling/Outputting in Parallel

## Operation with Default Configuration

This section describes the basic connections and signal flow with external devices. With the default settings, the Sensor operates in the following manner.

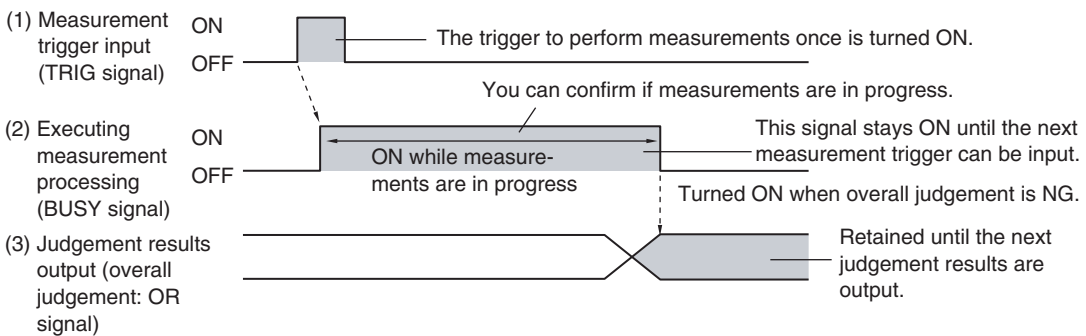
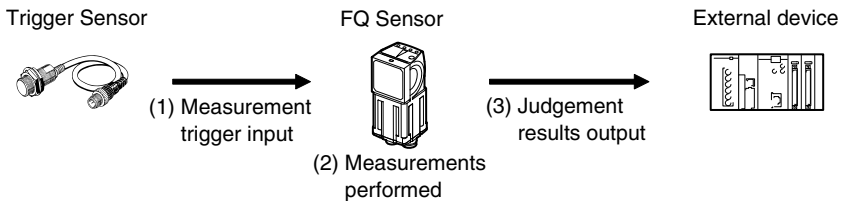

### Important

- Create the ladder program to control the TRIG and IN5 input signals so that they do not turn ON while the BUSY signal is ON. If not, a TRIG input error will occur and the ERROR signal will turn ON.
- Operation When the Sensor Power Supply Is Turned ON

The BUSY signal will operate as shown below when the Sensor's power supply is turned ON.

Create the ladder program in the PLC or other external device so that the BUSY signal is ignored while it turns OFF, ON, and OFF again for up to 5 s after the power supply is turned ON.

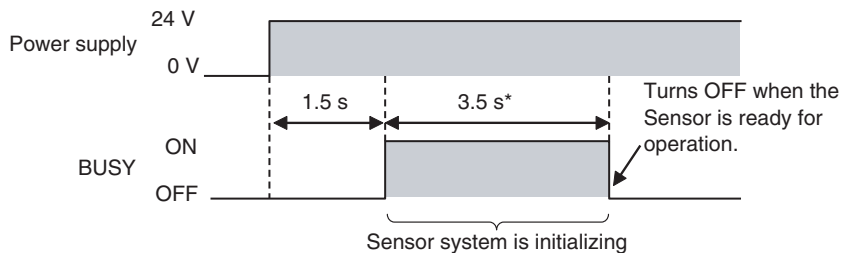

\* Depends on the scene data.

## Configuring the Operation

The following settings can be selected depending on the system configuration and application.

Type of change	Change	Reference
Changing the type of measurement trigger	Performing continuous measurements	p. 99
Changing the output method of the judgement results	Obtaining individual judgement results	p. 102
	Adjust the judgement output timing	p. 104
	Changing the judgement output ON conditions	p. 106
Changing the polarity of the BUSY output	Reversing the polarity of the BUSY signal	p. 106

## Setting the Measurement Trigger

The measurement trigger can be chosen from the following two types:

- One-shot measurement: One measurement is performed for each external trigger.
- Continuous measurement: Measurements are performed continuously.

### Performing One Measurement for Each External Trigger

A measurement trigger is input as the TRIG signal from a proximity sensor, PLC, or other external device. One measurement is performed when the TRIG signal turns ON.

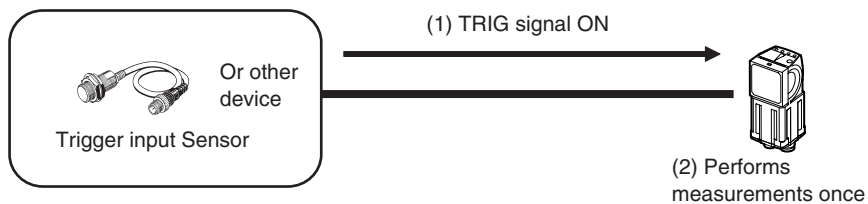

## Wiring

Color	Signal	Description
Pink	TRIG	Trigger signal
Black	OUT0 (OR)	Overall judgement (default assignment)
Orange	OUT1 (BUSY)	Processing in progress (default assignment)

The signals shown at the left are used. Refer to the following information for signal wiring.



Wiring: p. 26

## Timing Chart

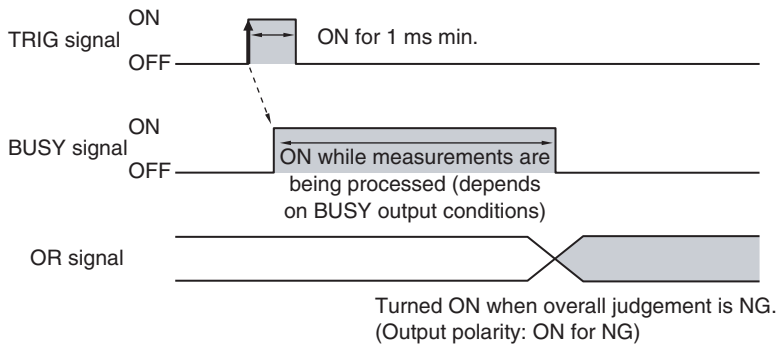

1. Turn ON the TRIG signal while the BUSY signal is OFF.
2. Measurement begins and the BUSY signal is turned ON during the measurement process.
3. When the measurement has been finished, the measurement result is output using an OR signal, and the BUSY signal is turned OFF. \*1

\*1: You can also set the signal to be turned OFF after data logging, image logging, or displaying results in the [BUSY output].

### Important

When the Brightness Correction Mode is ON, the timing when images are taken is delayed.



Timing Chart When the Brightness Correction Mode Is ON: p. 39

## Sample Ladder Program

The following sample program is used to input a TRIG signal to perform a single measurement. A single measurement will be performed when W0.00 turns ON.

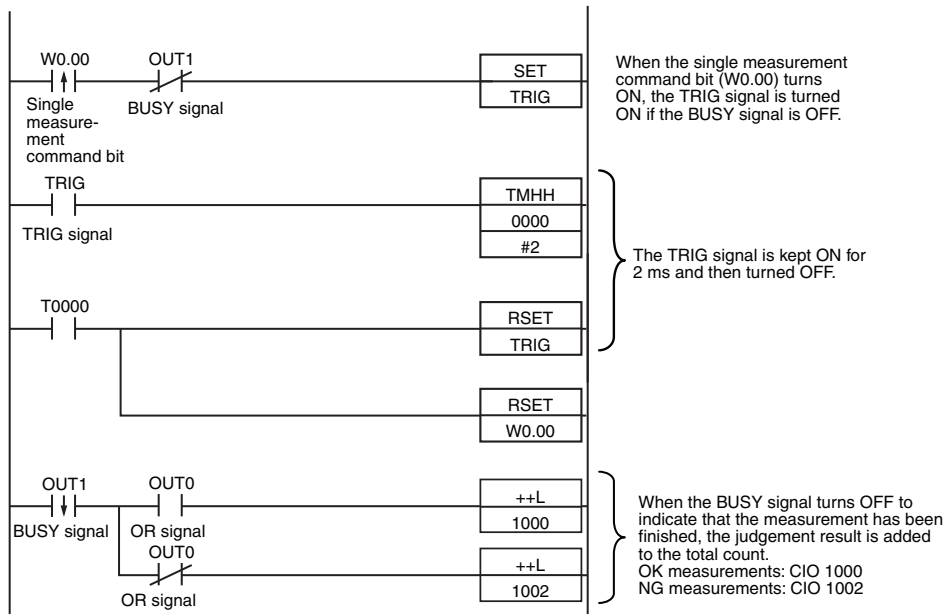

• I/O Signal Allocations

Signal		Address
Output signals	OUT0 (OR signal)	CIO 0.00
	OUT1 (BUSY signal)	CIO 0.01
Input signals	TRIG	CIO 1.00

**Important**

The BUSY signal will remain ON while the measurement is being executed.

## Performing Continuous Measurements

Continuous measurements are performed while the continuous measurement command is input from an external device.

Immediately after a measurement is performed, the next measurement is performed.

This is repeated while a continuous measurement command is input with the IN0 to IN5 signals.

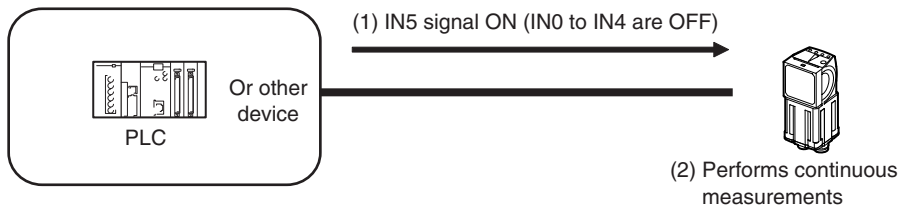

**Note**

This function can be used only when the input mode is set to Expanded Mode.

## Wiring

Color	Signal	State	Description
Gray	IN0	OFF	Command parameters for continuous measurements
Green	IN1	OFF	
Red	IN2	OFF	
White	IN3	OFF	
Purple	IN4	OFF	
Yellow	IN5	ON	Command input for continuous measurements
Black	OUT0 (OR)	--	Overall judgement (default assignment)
Orange	OUT1 (BUSY)	--	Processing in progress (default assignment)

The signals shown at the left are used. Refer to the following information for signal wiring.



Wiring: p. 26

## Timing Chart

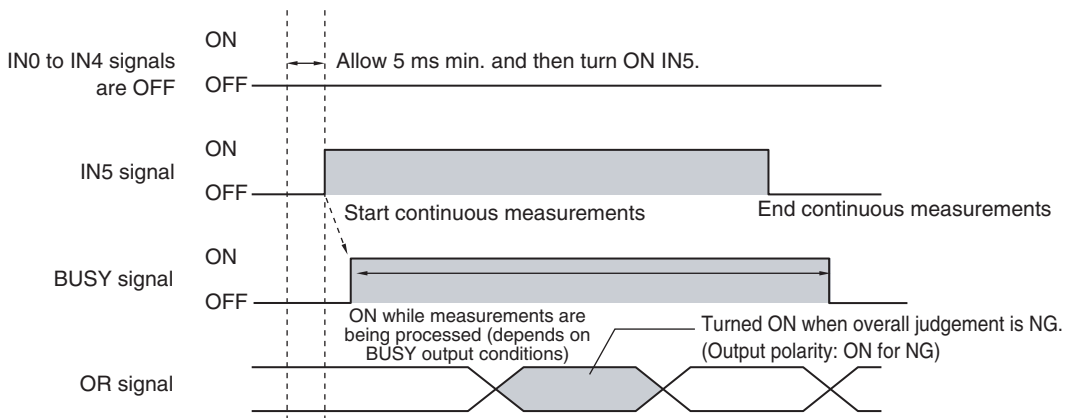

1. Turn ON IN5 while IN0 to IN4 are OFF. If status is held while the BUSY signal is OFF, continuous measurements will begin and the BUSY signal will remain ON while continuous measurements are being performed.
2. Continuous measurements end when IN5 is turned OFF.

## Settings

### ► [In/Out] – [I/O setting] – [I/O terminals] – [Input] – [Input mode]

Press [Expanded mode].

## Sample Ladder Program

The following sample program is used to input a IN5 signal to perform continuous measurements. Continuous measurements will be started when W0.00 turns ON and stopped when W0.01 turns ON.

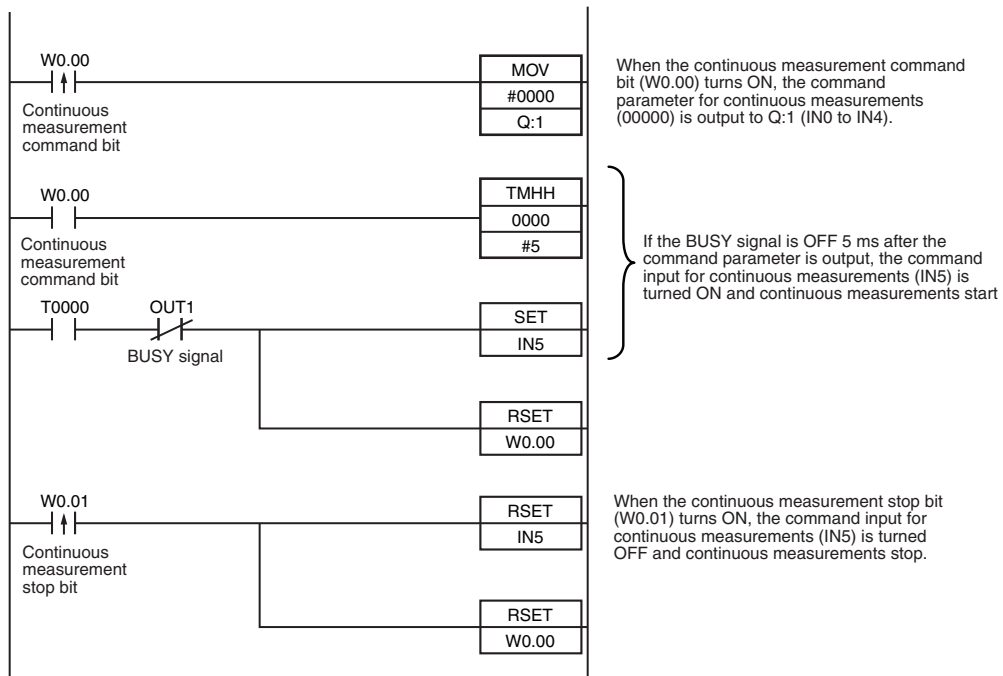

• I/O Signal Allocations

Signal	Address	
Output signals	OUT1 (BUSY signal)	CIO 0.01
Input signals	IN0	CIO 1.08
	IN1	CIO 1.09
	IN2	CIO 1.10
	IN3	CIO 1.11
	IN4	CIO 1.12
	IN5	CIO 1.15

## Setting the Outputs

### Using the Overall Judgement Result

When the results of the inspection items are judged, if even one individual judgement result is NG, the OR output signal is turned ON.

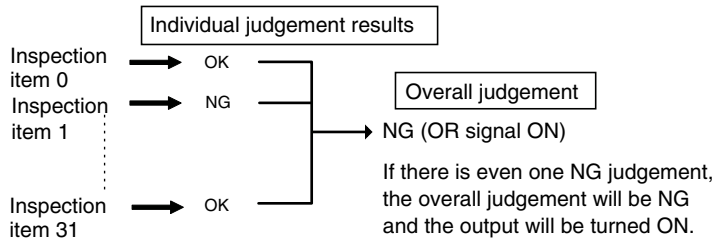

**Note**

The overall judgement result output signal can also be turned ON when all individual judgement results are OK.

Changing the judgement output ON condition: p. 106

### Wiring

Color	Signal	Description
Black	OUT0 (OR)	Overall judgement (default assignment)

The signals shown at the left are used. Refer to the following information for signal wiring.

2-4 Wiring: p. 26

## Timing Chart

The OR signal that is output is held until the next overall judgement is output.

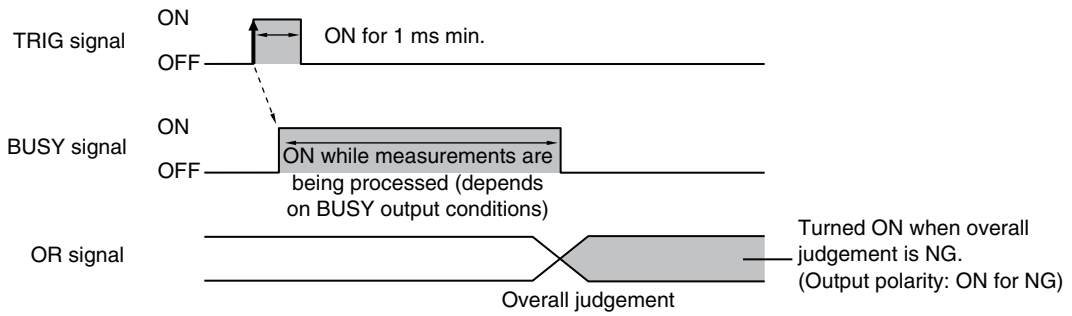

### Note

The timing for updating the OR signal and the ON time after judgement processing can be adjusted.

 Adjusting the judgement output timing: p. 104

## Obtaining Individual Judgement Results

Up to three judgement results of individual inspection items (individual judgement signals OR0 to OR31) can be assigned to terminals OUT0 to OUT2 and output to external devices.

Output terminal	Output signals that can be assigned
OUT0	<ul style="list-style-type: none"> <li>OR (Total judgement)...(default)</li> <li>OR0 (Item 0 judgement) to OR31 (Item 31 judgement)</li> </ul>
OUT1	<ul style="list-style-type: none"> <li>BUSY (default)</li> <li>OR0 (Item 0 judgement) to OR31 (Item 31 judgement)</li> </ul>
OUT2	<ul style="list-style-type: none"> <li>ERROR (default)</li> <li>OR0 (Item 0 judgement) to OR31 (Item 31 judgement)</li> </ul>

## Wiring

Example: Signals are assigned to terminals OUT0 to OUT2 as shown below.

- OUT0: Inspection number 2 (OR2)
- OUT1: Inspection number 5 (OR5)
- OUT2: Inspection number 14 (OR14)

Color	Signal	Description
Black	OUT0 (OR2)	Outputs the judgement for OR2.
Orange	OUT1 (OR5)	Outputs the judgement for OR5.
Light blue	OUT2 (OR14)	Outputs the judgement for OR14.

The signals shown at the left are used.  
Refer to the following information for signal wiring.

 2-4 Wiring: p. 26

As described above, if terminals OUT0 to OUT2 are all assigned to individual judgement output signals, the BUSY signal and ERROR signal assigned as the default settings will no longer be output.



## Timing Chart

Output OR0 to OR31 signals are held until the next judgement output.

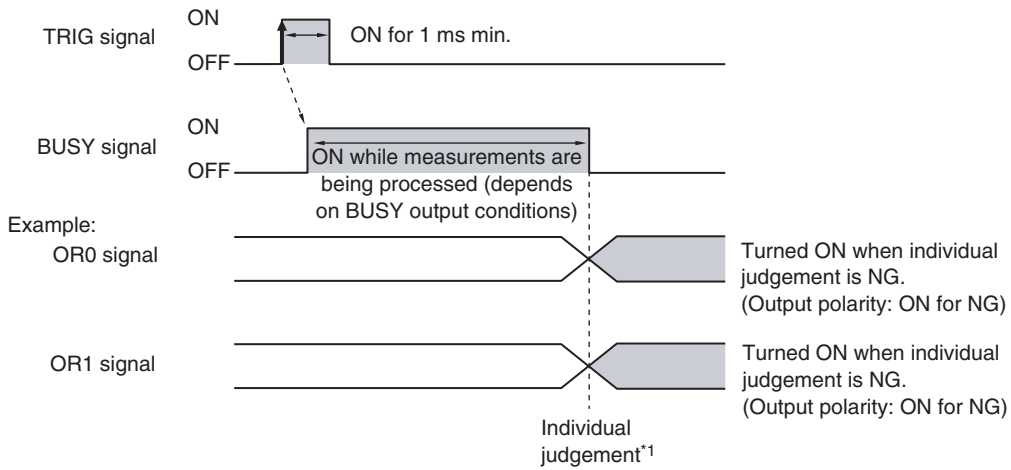

\*1: The timing for updating the OR signal is when the measurement results are finalized, regardless of the output settings of the BUSY signal (BUSY output conditions).

### Note

The timing for updating the OR0 to OR31 signals and the ON time after judgement processing can be changed.

Adjusting the judgement output timing: p. 104

## Settings

### ► [In/Out] – [I/O setting] – [I/O terminals] – [Output]

- 1 Press [OUT0].**
- 2 Press [OR2 (Item 2 judgement)].**  
OR2 output signal was assigned to OUT0.
- 3 Assign the others in the following manner.**  
OUT1: OR5  
OUT2: OR14

## Adjusting the Judgement Output Timing

The output timing of the OR signal or OR0 to OR31 signals can be selected from two modes depending on the external device.

### Selecting the OFF Timing

- Level output (default)

The status of the output OR signal is held until the next OR signal is output.

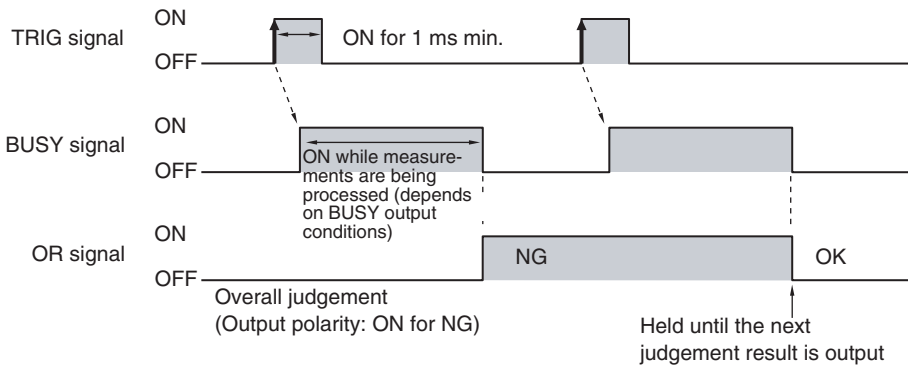

- One-shot output

The status of the output OR signal is turned OFF after a specified time has passed. (Setting range: 0 to 1,000 ms)

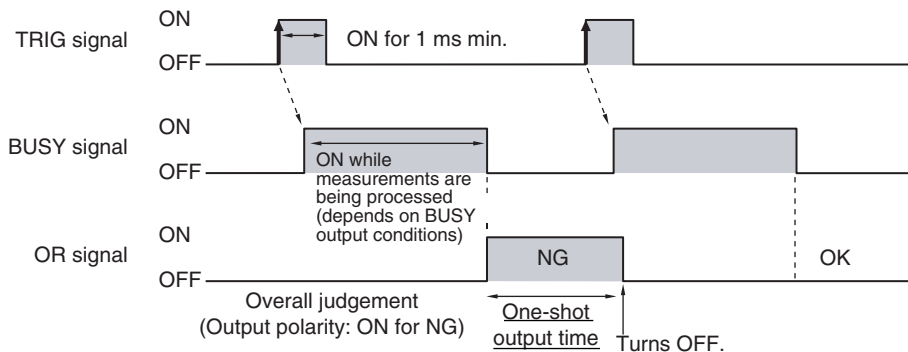

### Delaying the Output Timing

When using one-shot output, the output timing of the OR signal can be delayed. (Setting range: 0 to 1,000 ms)

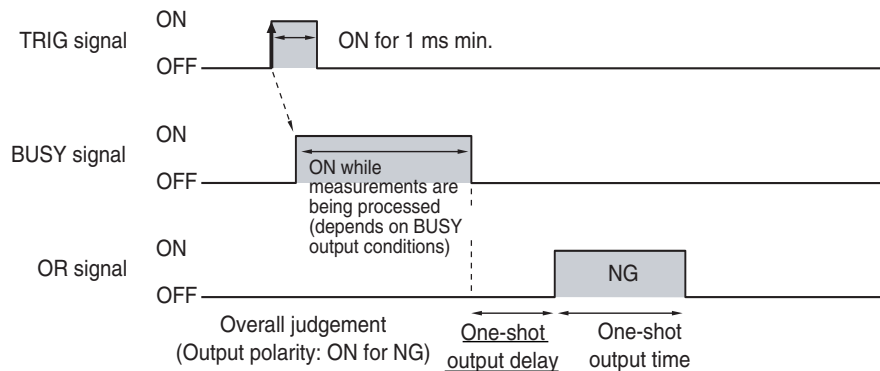

## Settings

### ► [In/Out] – [I/O setting] – [I/O terminals] – [Output]

- 1 Press [Output mode] and press [Level output] or [One-shot output].
- 2 Press [Output delay] and set the one-shot output delay.
- 3 Press [OK].

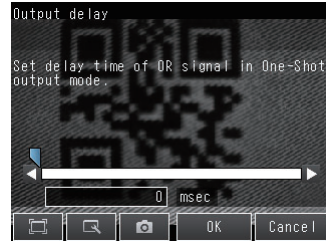

- 4 Press [Output time] and set the one-shot output time.
- 5 Press [OK].

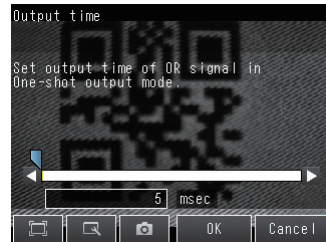

Item		Description
Output mode	One-shot output	After the measurement results are finalized, if the judgement output ON condition is met, the OR signal is turned ON for the one-shot output time. It is then turned OFF once the specified time has expired.
	Level output (default)	The judgement is output after measurement results are finalized and the ON/OFF status of the OR signal is held until it is changed for the next measurement result.
Output delay		When one-shot output mode is selected, this parameter sets the delay from when a measurement is completed until when the OR signal turns ON. (Setting range: 0 to 1,000 ms)
Output time		When one-shot output mode is selected, this parameter sets the time that the OR signal is ON. (Setting range: 1 to 1,000 ms)

### Important

When one-shot output is selected as the output mode, make the following value smaller than the trigger input period.

- One-shot delay time + One-shot output time

## Changing the Judgement Output ON Conditions

The ON condition for the OR signal or the OR0 to OR31 signals can be set to be output when the judgement results are OK or when they are NG. The default setting is when they are NG.

### Settings

#### ► [In/Out] – [I/O setting] – [I/O terminals] – [Output] – [Output polarity]

Item		Description
Output polarity	OK: ON	The output is turned ON if the judgement is OK. For the overall judgement, the output is turned ON if all judgements are OK.
	NG: ON (default)	The output is turned ON if the judgement is NG. For the overall judgement, the output is turned ON if even one judgements is NG.

## Changing the Polarity of the BUSY Output

The Sensor turns ON the BUSY output signal during measurements and other processing to indicate that a measurement trigger cannot be received. The polarity of the BUSY signal can be reversed so that it is ON only when a trigger signal can be received.

### Settings

#### ► [In/Out] – [I/O setting] – [I/O terminals] – [Output] – [BUSY polarity]

Item		Description
BUSY polarity	BUSY: ON (default)	The BUSY signal is ON while the Sensor is processing data.
	READY: ON	The BUSY signal is ON while the Sensor can receive a trigger signal.

#### Important

All timing charts in this manual show the operation of the BUSY signal at the default setting. If you change the polarity of the BUSY signal, take this into consideration when reading the timing charts.

## Changing the BUSY Output Condition

The end timing of the BUSY signal can be changed.

#### ► [In/Out] – [I/O setting] – [I/O terminals] – [Output] Tab Page – [BUSY output]

Item		Description
BUSY output	Measurement (default)	The BUSY signal turns OFF when the measurement is completed.
	Data logging	The BUSY signal turns OFF when data logging is completed.
	Image logging	The BUSY signal turns OFF when image logging is completed.
	Result display	The BUSY signal turns OFF when the result display is completed.

## Setting trigger error output

You can set whether an ERROR is output if an inspection trigger is detected when the BUSY signal is ON. The default setting is ON.

### Settings

#### ► [In/Out] – [I/O setting] – [I/O terminals] – [Output] – [Output trigger error]

Parameter	Description	
Trigger error signal	ON (default)	Outputs an ERROR if an inspection trigger is detected when the BUSY signal is ON.
	OFF	Does not output an ERROR if an inspection trigger is detected when the BUSY signal is ON. An inspection trigger detected while the BUSY signal is ON is disregarded.

## Controlling the Sensor from an External Device

The following Sensor functions can be controlled with command inputs from an external device without connecting the Touch Finder.

Function	Description	Reference
Switching the scene	This command changes the scene when the line process changes.	p. 107
Clearing an error	This command turns the ERROR signal OFF.	p. 110
Continuous measurement	Continuous measurement is performed while this command is input.	p. 99
Trigger retry	Continues inspection when the trigger signal is ON.	p. 111
Reset	Resets the sensor.	p. 114
Teach	Registers a 2D code.	p. 116

## Changing the Scene

This section describes how to change the line process by changing the scene.

### Wiring

Color	Signal	State		Description
		Input Mode		
		Standard Mode	Expanded Mode	
Gray	IN0	Scene number (0 to 31)	Scene number (0 to 15)	Specifies the scene number.
Green	IN1			
Red	IN2			
White	IN3			
Purple	IN4		ON	
Yellow	IN5	ON		Trigger to change the scene
Orange	OUT1 (BUSY)	--		Processing in progress (default)

The signals shown at the left are used.  
Refer to the following information for signal wiring.



2-4 Wiring: p. 26

## Timing Chart

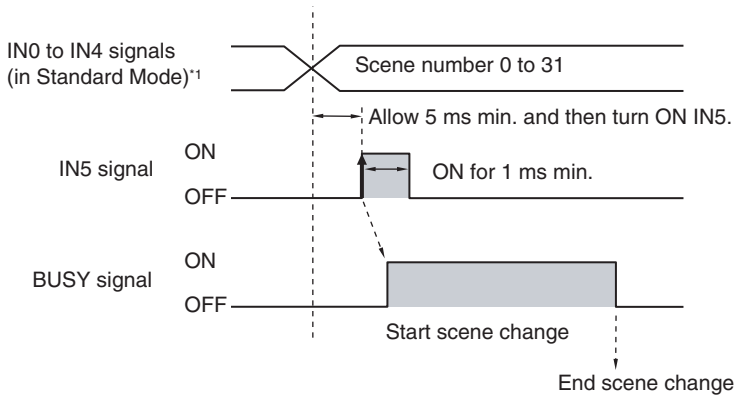

\*1: In Expanded Mode, specify scene numbers 0 to 15 using the IN0 to IN3 signals.

- 1 Specify the scene number with the IN0 to IN4 signals. (Standard Mode)
- 2 Turn ON the IN5 signal while the BUSY signal is ON to change the scene to the specified scene.
- 3 The BUSY signal turns ON while the scene is being switched.

## Settings

### ► [In/Out] – [I/O setting] – [I/O terminals] – [Input] – [Input mode]

The scene numbers that can be used depend on the input mode.

[Standard mode] (default): Scene 0 to 31

[Expanded mode]: Scene 0 to 15

## Sample Ladder Program

This sample program is used to change the scene when the input mode is set to Expanded Mode. The scene changes to scene 1 when W0.00 turns ON.

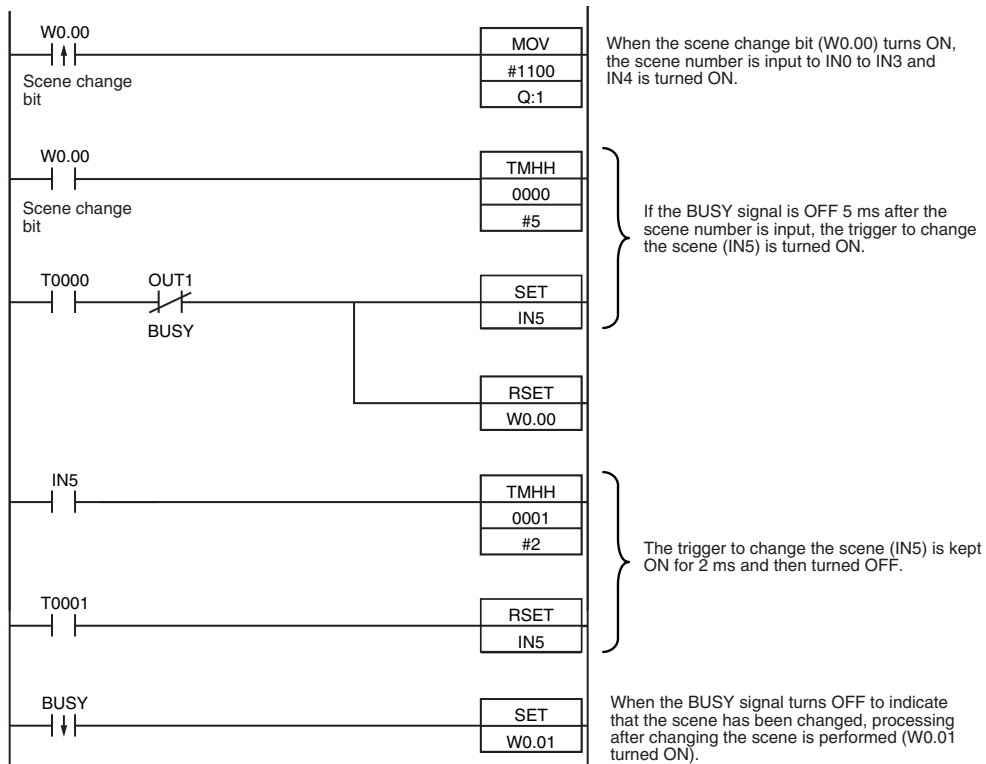

### • I/O Signal Allocations

Signal	Address
Output signals	OUT1 (BUSY signal) CIO 0.01
Input signals	IN0 CIO 1.08
	IN1 CIO 1.09
	IN2 CIO 1.10
	IN3 CIO 1.11
	IN4 CIO 1.12
	IN5 CIO 1.15

#### Note

The BUSY signal will be ON while the scene it being changed.

#### Important

If the cycle time is too long, the PLC may not be able to detect when the BUSY signal is ON. If necessary, turn OFF W0.00 after a suitable time elapses.

## Turning the ERROR Signal OFF

The ERROR signal turns ON when an error occurs.

After removing the cause of the error, turn the ERROR signal OFF using one of the following methods.

Method 1: Input an error clear command from an external device such as a PLC.

Method 2: Input a measurement trigger again.

(For example, turn the TRIG signal ON during a one-shot measurement.)

The ERROR signal will turn OFF when measurement is executed correctly.

### Note

This function can be used in Run Mode only.

## Settings

▶ **[In/Out] – [I/O setting] – [I/O terminals] – [Input] – [Input mode]**

Press [Expand mode].

## Wiring

Color	Signal	State	Description
Gray	IN0	OFF	Command parameter for clearing errors
Green	IN1	OFF	
Red	IN2	ON	
White	IN3	OFF	
Purple	IN4	OFF	
Yellow	IN5	ON	Command input for clearing errors
Orange	OUT1 (BUSY)	--	Processing in progress (default)
Light blue	OUT2 (ERROR)	--	ERROR signal (default)

The signals shown at the left are used.

Refer to the following information for signal wiring.



2-4 Wiring: p. 26

## Timing Chart

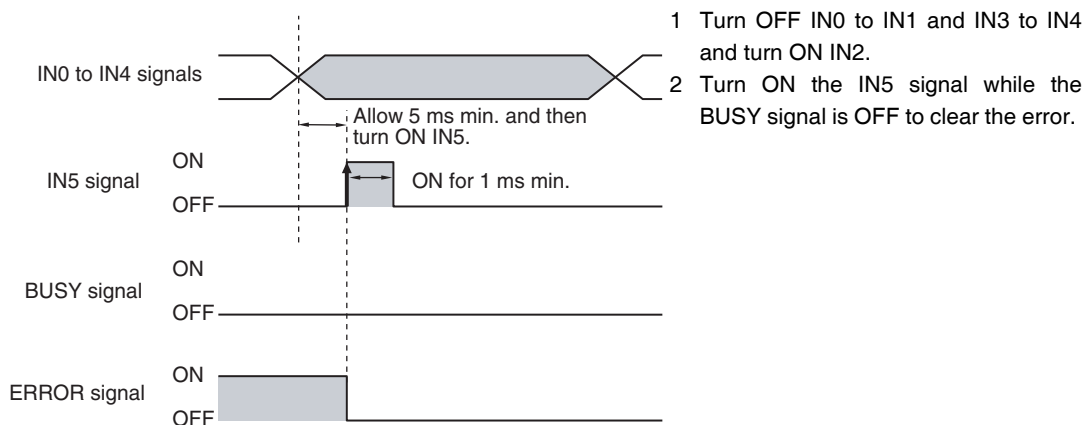



## Retry inspection by external signal (trigger retry)

Inspection is repeated until all inspection items have been successfully scanned.

Retry inspection ends when any one of the following conditions is satisfied:

- (1) The scanning result of all inspection items is OK.
- (2) The trigger retry command turns OFF.
- (3) The timeout time is exceeded.

### Note

This function can only be used in run mode.

### Settings

To use this function, the input mode must be set to "Expanded mode".

► [In/Out] – [I/O setting] – [I/O terminals] – [Input] – [Input mode]

### Wiring

Color	Signal	State	Description
Gray	IN0	OFF	Command parameters for trigger retry
Green	IN1	OFF	
Red	IN2	ON	
White	IN3	ON	
Purple	IN4	OFF	
Yellow	IN5	ON	Command input for trigger retry
Orange	OUT1 (BUSY)	--	Busy
Black	OUT0 (OR)	--	Overall judgment (default)

The signals at left are used. For the wiring of each signal, refer to the following:



2-4 Wiring: p. 26

### Timing chart When inspection is OK

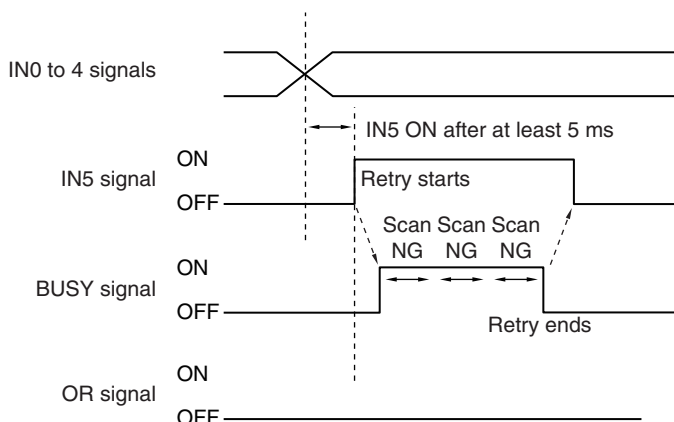

- 1 IN0, 1 and 4 are turned OFF, IN2 and 3 are turned ON.
- 2 When IN5 is turned OFF > ON with the BUSY signal OFF, trigger retry inspection starts.
- 3 When retry inspection starts, the BUSY signal turns ON.
- 4 When the overall judgment turns ON, retry inspection ends and the BUSY signal turns OFF.
- 5 After verifying that the BUSY signal has turned ON > OFF, IN5 is turned ON > OFF.

## Timing chart When inspection is NG

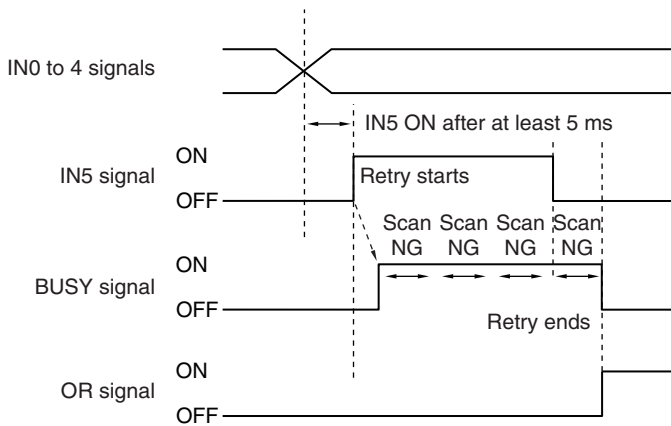

- 1 IN0, 1 and 4 are turned OFF, IN2 and 3 are turned ON.
- 2 When IN5 is turned OFF > ON with the BUSY signal OFF, trigger retry inspection starts.
- 3 When retry inspection starts, the BUSY signal turns ON.
- 4 If retry inspection ends but the overall judgment is NG, the OR signal turns ON. (Output polarity: When ON at NG)

## Sample Ladder Program

This sample ladder program executes trigger retry when the I/O input mode is expanded mode. Trigger retry is executed at W0.00 ON.

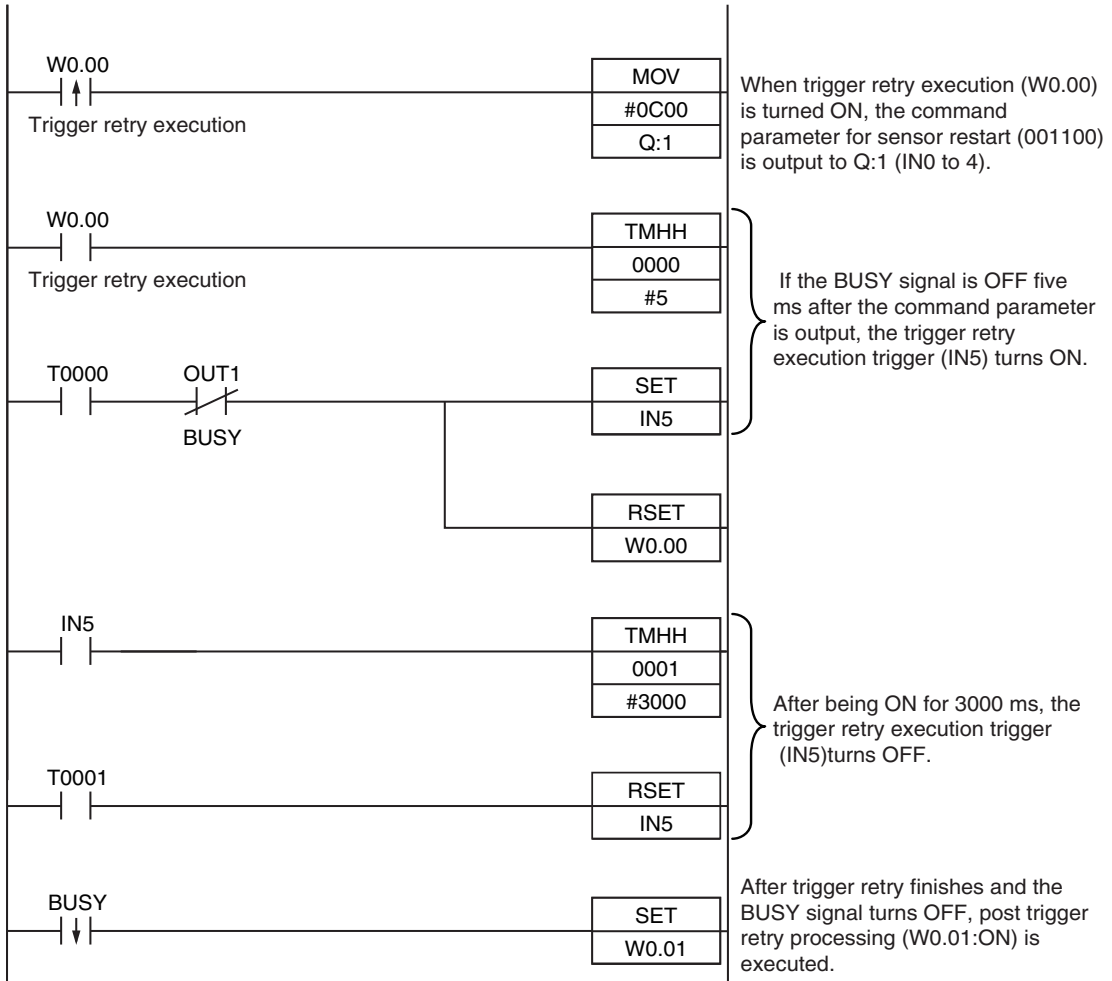

### • I/O Signal Allocations

Signal type	Address	
Output signal	OUT1 (BUSY signal)	CIO 0.01
Input signals	IN0	CIO 1.08
	IN1	CIO 1.09
	IN2	CIO 1.10
	IN3	CIO 1.11
	IN4	CIO 1.12
	IN5	CIO 1.15

#### Note

The time the BUSY signal is ON is the trigger retry execution time.

## Important

It may happen that the PLC is unable to recognize BUSY signal ON because the sample time is slow or otherwise. In this event, have W0.00 turn OFF at a suitable time.

## Resetting the sensor

Sensor reset is explained below.

### Note

This function can only be used in Run mode.

## Settings

To use this function, the input mode must be set to "Expanded mode".

► [In/Out] – [I/O setting] – [I/O terminals] – [Input] – [Input mode]

## Wiring

Color	Signal	State	Description
Gray	IN0	OFF	Command parameters for sensor reset
Green	IN1	ON	
Red	IN2	OFF	
White	IN3	ON	
Purple	IN4	OFF	
Yellow	IN5	ON	Command input for sensor reset
Orange	OUT1 (BUSY)	--	Busy (default)

The signals at left are used. For the wiring of each signal, refer to the following:



2-4 Wiring: p. 26

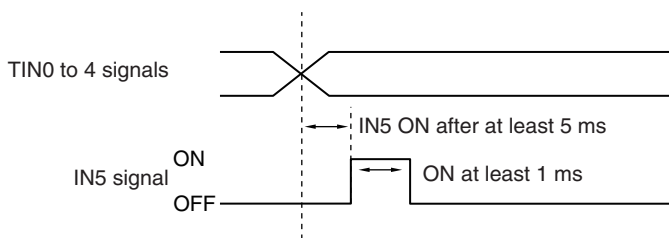

- 1 IN0, 2 and 4 are turned OFF, IN1 and 3 are turned ON.
- 2 IN5 is turned OFF > ON with the BUSY signal OFF. The BUSY signal does not turn ON while the restart command is being received.
- 3 When the initialization process starts, the BUSY signal turns ON.

For the initialization process, refer to the following:



Operation with Default Configuration  
p.96

## Sample Ladder Program

This sample program inputs IN5 to restart the sensor.  
Trigger retry is executed at W0.00 ON.

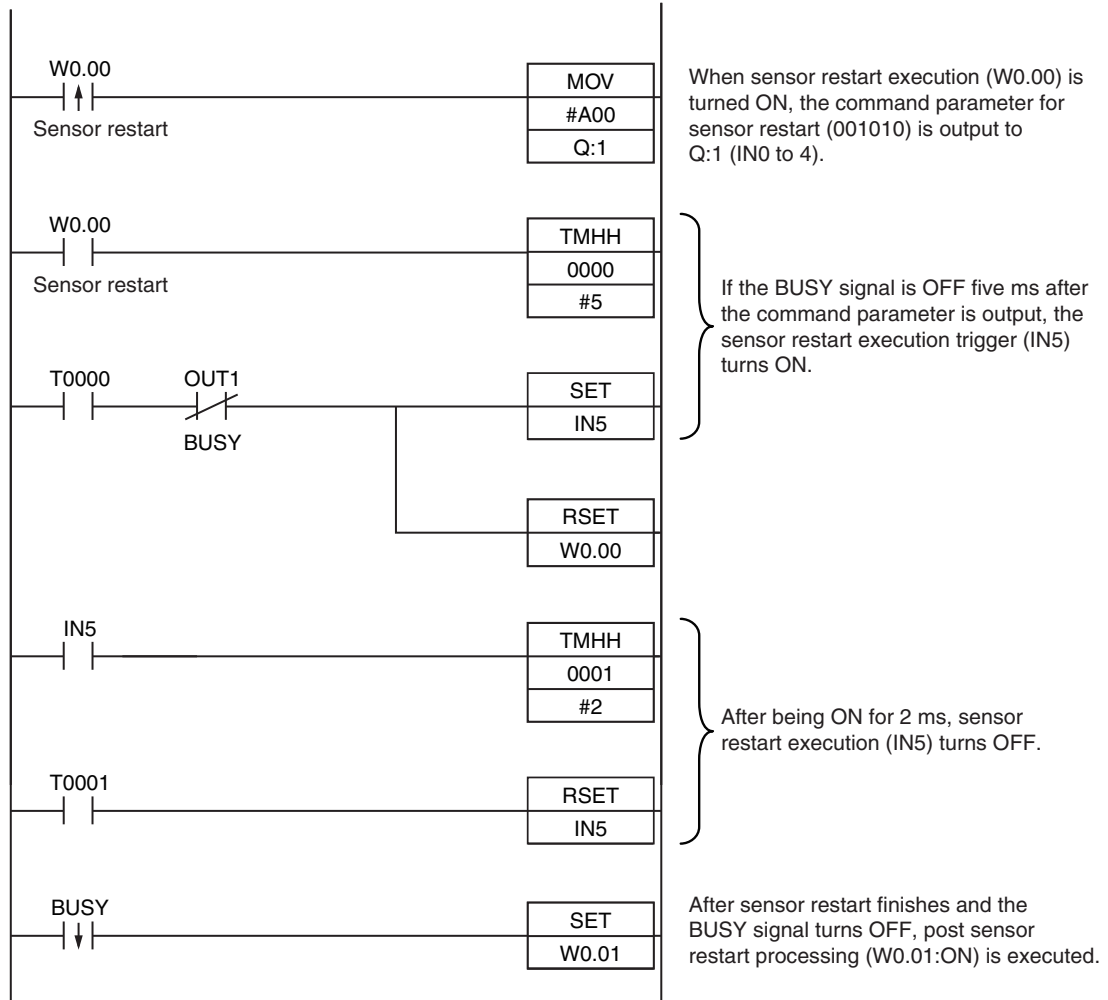

### • I/O Signal Allocations

Signal type	Address	
Output signal	OUT1 (BUSY signal)	CIO 0.01
Input signals	IN0	CIO 1.08
	IN1	CIO 1.09
	IN2	CIO 1.10
	IN3	CIO 1.11
	IN4	CIO 1.12
	IN5	CIO 1.15

#### Note

The time the BUSY signal is ON is the sensor initialization process execution time.

## Important

It may happen that the PLC is unable to recognize BUSY signal ON because the cycle time is slow or otherwise. In this event, have W0.00 turn OFF at a suitable time.

## Executing teach

Teach is executed as explained below.

### Note

This function can only be used in Run mode.

## Settings

To use this function, the I/O input mode must be set to "Expanded mode".

► [In/Out] – [I/O setting] – [I/O terminals] – [Input] – [Input mode]

## Wiring

Color	Signal	State	Description
Gray	IN0	OFF	Command parameters for teach execution
Green	IN1	ON	
Red	IN2	OFF	
White	IN3	OFF	
Purple	IN4	OFF	
Yellow	IN5	ON	Command input for teach execution
Orange	OUT1 (BUSY)	--	Busy (default)

The signals at left are used.  
For the wiring of each signal,  
refer to the following:



2-4 Wiring: p. 26

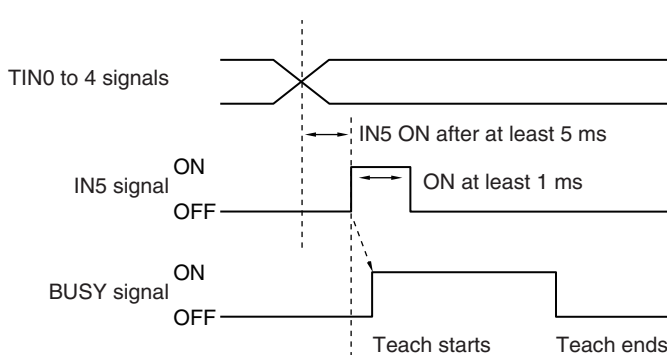

- 1 IN0, 1, 3 and 4 are turned OFF, IN1 is turned ON.
- 2 IN5 is turned OFF > ON with the BUSY signal OFF.
- 3 When teach starts, the BUSY signal turns ON.
- 4 When teach ends, the BUSY signal turns OFF.

## Sample Ladder Program

This sample program inputs IN5 to execute teach.

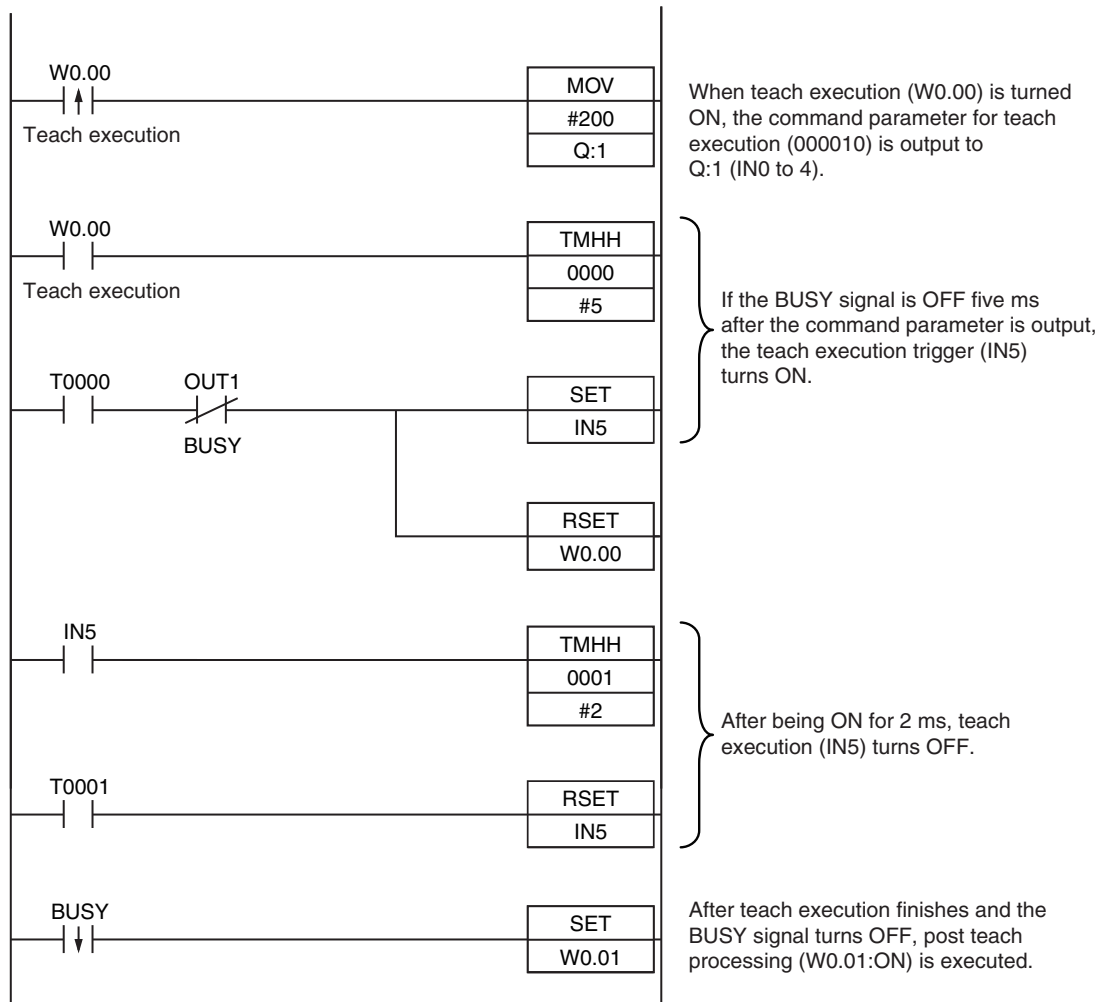

### • I/O Signal Allocations

Signal type		Address
Output signal	OUT1 (BUSY signal)	CIO 0.01
Input signals	IN0	CIO 1.08
	IN1	CIO 1.09
	IN2	CIO 1.10
	IN3	CIO 1.11
	IN4	CIO 1.12
	IN5	CIO 1.15

#### Note

The time the BUSY signal is ON is the teach execution time.

#### Important

It may happen that the PLC is unable to recognize BUSY signal ON because the cycle time is slow or otherwise. In this event, have W0.00 turn OFF at a suitable time.

## 8-2 Outputting/Controlling with Ethernet

Data can be input and output to external devices via Ethernet. The two methods are described below.

- No-protocol Data Output

Data that is already specified for output is automatically output from the Sensor to Ethernet when an overall judgement result is output. Up to 32 data can be output in the specified format (ASCII format or binary format).

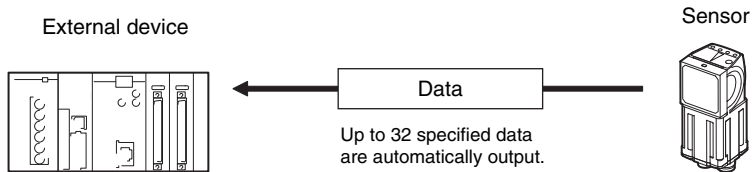

- No-protocol Command/Response Method

The external device sends a command to the Sensor and receives a response from the Sensor.

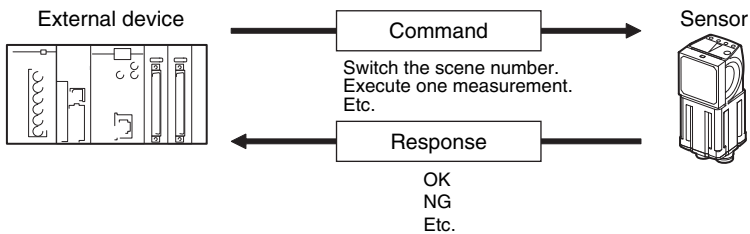



## Connections

Connect the Switching Hub and PLC using an FQ-WN□□ Special Ethernet Cable.

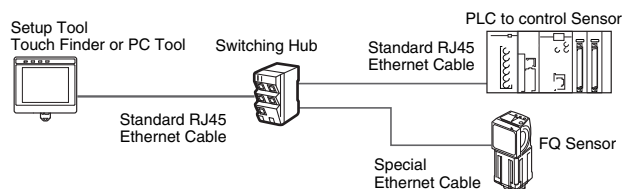

### Important

When connecting more than one Sensor, set the IP addresses so that the same IP address is not used for more than one Sensor.

## Set the Basic Settings of the Ethernet

Use the following procedure to turn OFF automatic settings for Ethernet, and enter the IP address and subnet mask.

### ► [Sensor settings] – [Network] – [Ethernet]

- 1** Press [Auto connection].
- 2** Press [OFF] to select it.  
You can now set the IP address manually.
- 3** Enter the IP address and subnet mask.

Item	Purpose	Setting range
IP address	Enter the IP address of the Sensor.	a.b.c.d a: 1 to 223 b: 0 to 255 c: 0 to 255 d: 2 to 254 (Default: 10.5.5.100)
Subnet mask	Enter the subnet mask.	0.0.0.0 to 255.255.255.255 (Default: 255.255.255.0)

### Note

The port number is always 9876.

## Setting the Data to Output via Ethernet

Allocate the data to output via Ethernet according to the output method for the Ethernet as shown below.

- No-protocol Command/Response Method

When executing one-shot measurements and continuous measurements with commands (MEASURE or M, MEASURE/C or M/C), set the data to output via Ethernet as a response.

- No-protocol Data Output

Set in advance the data to output via Ethernet after the measurements (32 max.).

### Data That Can Be Output

Up to 32 data can be output (data 0 to data 31).

### Allocating Output Data

Allocate Ethernet output data to data 0 to 31. Data that can be assigned are the judgment, number of detected characters, cell recognition rate, contrast, and focus.

The settings for outputting the [0.2D-code] judgment JG to data 0 are explained below.

#### ► [In/Out] – [I/O setting] – [Ethernet] – [Output data set]

**1** Press [0. Data 0].

**2** Press [Settings].

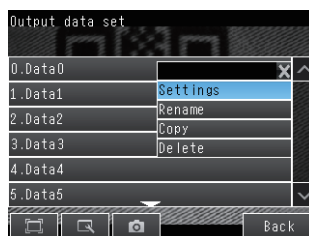

**3** Press [0.2D-code].



**4** Press [Judgement JG].

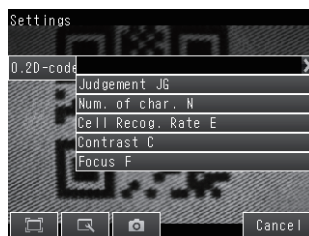

This process is repeated to register data 1 or higher.

## Outputting the Scan Result

You can specify whether the scanned text string is output.

The procedure for setting output of the scanned text string of a [0.2D-code] is explained below.

### ► [In/Out] – [I/O setting] – [Ethernet] – [Output character set]

**1** Press [0.2D-code] in "Output character set".



**2** Set [String output on/off], [Partial output on/off], [Output string setup], and [NG String output on/off].

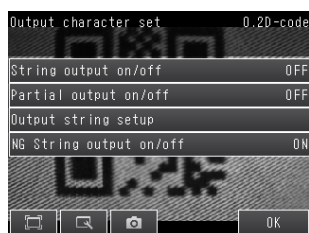

Parameter	Settings	Description
String output on/off	OFF (default), ON	Sets whether the scan result is output by Ethernet.
Partial output on/off	OFF (default), ON	When "String output on/off" is ON, selects whether a range of the scanned data is specified for output.
Output string setup	1 to 1024 (Default setting - starting character: 1, ending character: 1024)	Sets the starting character and ending character of output. If the set character does not exist in the scanned text string, an error output code is output.
NG String output on/off	OFF (default), ON	Sets whether an NG result (?E000, ?E100, ?E200, ?E300) is output by Ethernet.

Repeat the above to output scan results of Inspection Items following [0.2D-code].

## Note

- Output order

When scan results and data are output by Ethernet, data is output first followed by the scan result (text string).

Example - Scan result: ABC

When

[Data output] - [Data 0]: 0 (judgment OK)

[Data output] - [Data 2]: 100 (cell recognition rate)

output is in the following order:

0 (field separator) 100 (record separator) ABC (record separator) CR

- Code conversion

The following character codes are converted before output:

Character code	Before conversion	After conversion
Comma	&h2c	&h8540
Tab	&h09	&h8541
Space	&h20	&h8542
CR	&h00	&h8543
LF	&h0A	&h8544

## Outputting Data to an External Device Using No-protocol Communications

### Setting the Data To Output Automatically

 Refer to *Setting the Data to Output via Ethernet*.

### Setting the Data Format

#### ► [In/Out] – [I/O setting] – [Ethernet]

- 1 Press [Output form].
- 2 Set the output format to ASCII or binary.
- 3 Set the data format.

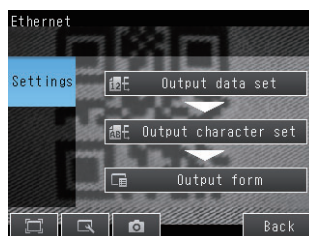

- When Output Format Is ASCII

Set the parameters for integer digits, decimal digits, negative numbers, 0 suppression, the field separator, and the record separator.

**• Output Format**

Measured value of data 0	,	Measured value of data 1	,	...	Measured value of data 7	CR
--------------------------	---	--------------------------	---	-----	--------------------------	----

**Note**

The data output method, digits, and data separators can be changed as needed.

Example: Integer digits: 5, decimal digits: 3, negative number expression: -, field separator: comma, record separator: CR

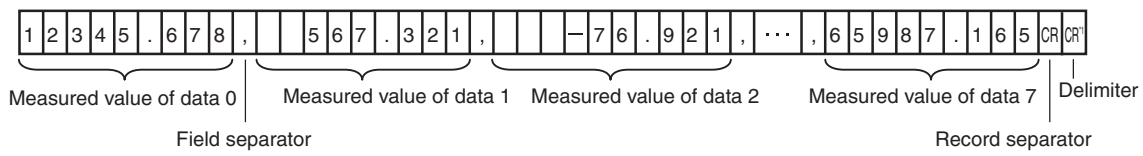

\*1 Because the record separator is set to CR, only one record is output for each measurement. A blank line (CR: delimiter) will therefore be entered after the record separator. If you do not want a blank line, set the record separator to None.

**Note**

The field separator is not output unless the data continues.

The following range of values can be output.

$$-999,999,999.9999 \leq \text{Measured value} \leq 999,999,999.9999$$

If the measured value is lower than -999,999,999.9999, then -999,999,999.9999 is output.

If the measured value is higher than 999,999,999.9999, then 999,999,999.9999 is output.

The following values are output if JG (Judge) is set.

OK: 0

NG: -1

**Note**

Data that is output after measurement is output until the last data even after the measurement is finished. Data output is not interrupted midway.

**• When Output Format Is Binary**

Set the numerical expression.

Select either fixed decimal or floating-point decimal.

**• Output Format**

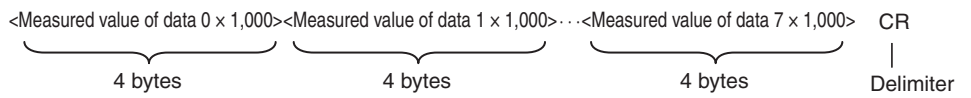

The measurement data multiplied by 1,000 is output continuously at 4 bytes per data. Negative numbers are output as two's complements.

Example: When Data 0 is 256.324 and Data 1 is -1.000.

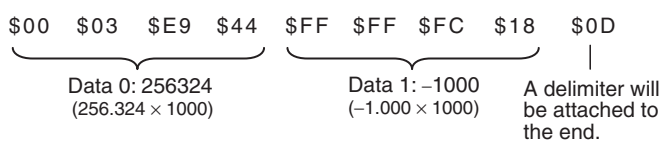

**Note**

---

Binary output does not use data separators, i.e., field separators or record separators. These separators are used only for ASCII output.

---

The following range of values can be output.

$-2,147,483.648 \leq \text{Measured value} \leq 2,147,483.647$

If the measured value is lower than  $-2,147,483.648$ , then  $-2,147,483.648$  is output.

If the measured value is higher than  $2,147,483.648$ , then  $2,147,483.648$  is output.

The following values are output if JG (Judge) is set.

OK: 0 ( $0 \times 1000$ )

NG:  $-1000$  ( $-1 \times 1000$ )

**Note**

---

Data that is output after measurement is output until the last data even after the measurement is finished. Data output is not interrupted midway.

---

### Command Format

This section describes the command format for no-protocol communications.

Commands defined in the command list can be used.

Set commands and parameters in ASCII.

If the command has an argument parameter, set the parameter after inserting a space (0x20).

If it has multiple parameters, insert a space before each parameter.

Place a delimiter at the end of the command. No space is required before the delimiter.

The delimiter is always CR.

<Command Format>

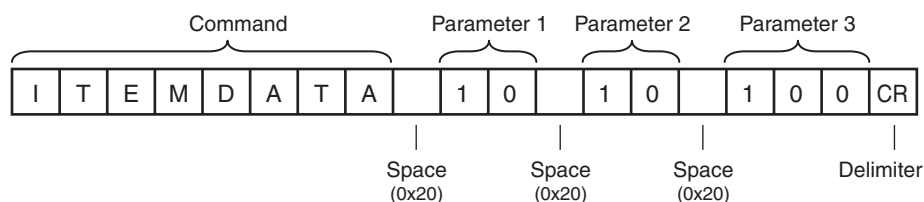

<Response Format>

If a parameter is attached, the parameter and delimiter are output when the command is processed normally, and the command execution result is OK. A delimiter is inserted at the end of the response.

The delimiter is always CR.

Command Execution Result

Parameter

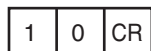

Delimiter

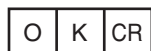

Delimiter

If the command is not processed normally, the command execution result is NG.

Command Execution Result

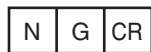

Delimiter

An error occurs in the following cases.

- A non-existent command was specified.
- The number of parameters is incorrect.
- The parameter range is incorrect.
- The parameter content is incorrect.
- Operation could not be performed normally for the operation command.

## Command List

The following table lists the no-protocol commands.

Commands that can be used in no-protocol Ethernet communications are listed below.

Type of command	Command	Abbreviation	Function	Reference
Scene control commands	SCENE	S or SN	Acquires the current scene number.	p. 127
	SCENE <i>Scene_number</i>	S <i>Scene_number</i> or SN <i>Scene_number</i>	Changes the scene number being used.	p. 128
Measurement control commands	MEASURE	M	Executes one measurement.	p. 129
	MEASURE/C	M/C or GC	Starts continuous measurements.	p. 130
	MEASURE/E	M/E or SC	Ends continuous measurements.	p. 131
	TEACH	FT	Executes 2D code teaching.	p. 132
Data acquisition/setting commands	LASERTIME	LT	Acquires the shutter time.	p. 133
	LASERTIME <i>Set_value</i>	LT <i>Set_value</i>	Sets the shutter time.	p. 134
	GAIN	GN	Acquires the gain.	p. 135
	GAIN <i>Set_value</i>	GN <i>Set_value</i>	Sets the gain.	p. 136
	BRIGHTNESS	BN	Acquires the brightness.	p. 137
	BRIGHTNESS <i>Set_value</i>	BN <i>Set_value</i>	Sets the brightness.	p. 138
	FILTERDATA <i>External_reference_data_number</i>	FD <i>External_reference_data_number</i>	Acquires filter setting information.	p. 139
	FILTERDATA <i>External_reference_data_number</i> <i>Set_value</i>	FD <i>External_reference_data_number</i> <i>Set_value</i>	Sets filter setting information.	p. 140
	ITEMDATA <i>Inspection_item_number</i> <i>External_reference_data_number</i>	ID <i>Inspection_item_number</i> <i>External_reference_data_number</i>	Acquires the inspection item data.	p. 141
	ITEMDATA <i>Inspection_item_number</i> <i>External_reference_data_number</i> <i>Set_value</i>	ID <i>Inspection_item_number</i> <i>External_reference_data_number</i> <i>Set_value</i>	Sets the inspection item data.	p. 142
Setting acquisition command	VERGET/S	VR	Acquires the version information of the Sensor software.	p. 144
	VERGET/H	None	Acquires the Sensor model information.	p. 145
	ERRGET	None	Acquires the latest error code of the Sensor.	p. 146
	SAVEALLDATA	SV	Saves all sensor information.	p. 147
Utility commands	CLRMEAS	None	Clears the measurement values.	p. 148
	CLRERR	None	Clears the error output status (error signal and error indicator).	p. 149
	RESET	None	Restarts the Sensor.	p. 150



## Command Details

### Scene Control Commands

#### ● SCENE or S or SN

##### Acquire Scene Number

This command acquires the scene number currently being used.

##### <Command Format>

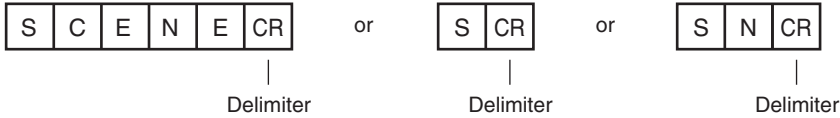

##### <Response Format>

When the Command Is Processed Normally

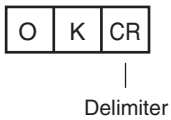
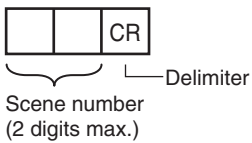

When the Command Is Not Processed Normally

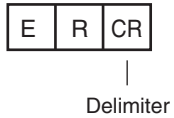

##### <Parameter Descriptions>

Scene number	The acquired scene number (currently used scene number) is returned.
--------------	--

Example:

When Scene 0 Is Being Used

##### <Command>



##### <Response>

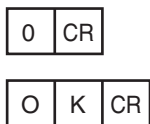

## Change Scene Number

This command changes the scene number to use.

### <Command Format>

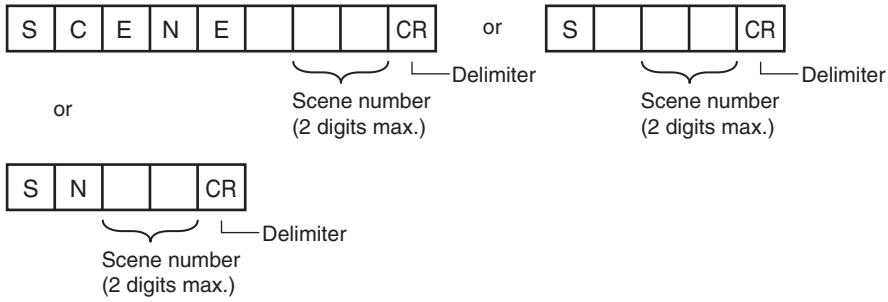

### <Response Format>

When the Command Is Processed Normally

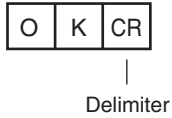

When the Command Is Not Processed Normally

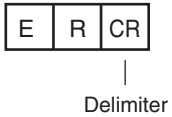

### <Parameter Descriptions>

Scene number	Specifies the scene number (0 to 31) to change to.
--------------	--

## Measurement Control and Measurement Acquisition Commands

- MEASURE or M or GL/GC/SC

### Execute Measurement

This command executes one measurement.

If Ethernet output is not set, only the measurement is performed.

If Ethernet output is set, the measurement is performed and the result is returned as response data.

#### <Command Format>

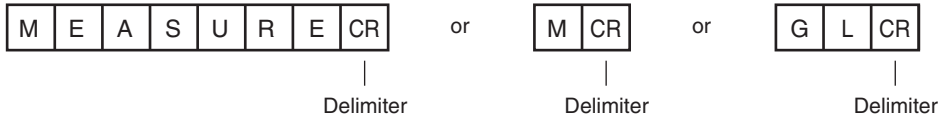

#### <Response Format>

When the Command Is Processed Normally

`O K C R`

Measurement  
result `C R`

|  
Delimiter

When the Command Is Not Processed Normally

`E R C R`

|  
Delimiter

#### <Parameter Descriptions>

Measurement result	<p>The measurement result is output as the response when Ethernet output is set.                  The measurement result is not output when Ethernet output is not set.</p> <p> Reference: <i>Setting the Data to Output via Ethernet</i> (p. 120)</p>
--------------------	---

### Start Continuous Measurements

This command starts continuous measurements.

If Ethernet output is not set, only continuous measurement is performed.

If Ethernet output is set, continuous measurement is performed and the results corresponding to the number of measurements made are returned as response data.

#### <Command Format>

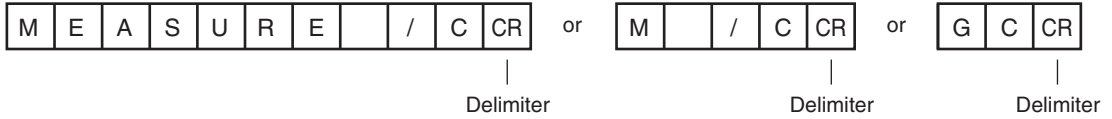

#### <Response Format>

When the Command Is Processed Normally

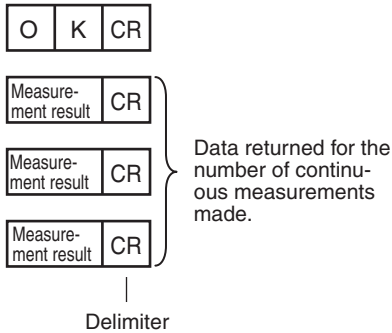

When the Command Is Not Processed Normally

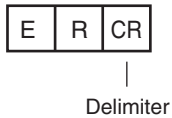

#### <Parameter Descriptions>

Measurement result	<p>The measurement results corresponding to the number of measurements made are output when Ethernet output is set.</p> <p>The measurement result is not output when Ethernet output is not set.</p> <p> Reference: <i>Setting the Data to Output via Ethernet</i> (p. 120)</p>
--------------------	--

## End Continuous Measurements

The command ends continuous measurements.

### <Command Format>

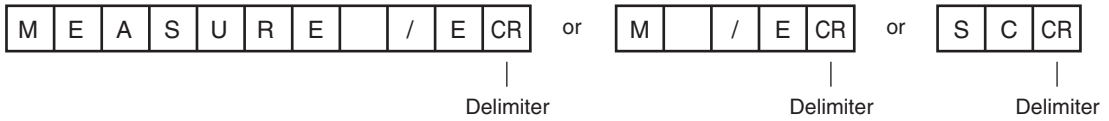

### <Response Format>

When the Command Is Processed Normally

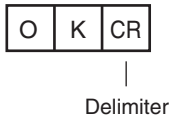

When the Command Is Not Processed Normally

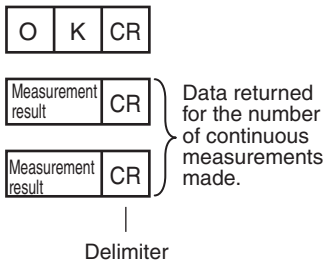

### Note

Set the Ethernet output to output measurement results.  
If Ethernet output is not set, only the command response is output.

 Reference: *Setting the Data to Output via Ethernet* (p. 120)

● TEACH

Execute Teaching

This command executes 2D code teaching.

<Command Format>

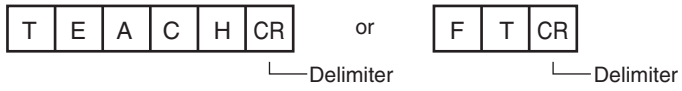

<Response Format>

When scanning is successful

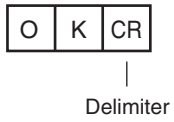

When scanning fails

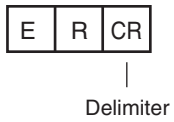

### Acquire Shutter Time

This command acquires the shutter time.

This command is only valid when the HDR function is OFF.

#### ● LASERTIME or LT

##### <Command Format>

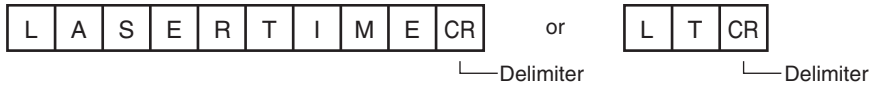

##### <Response Format>

When the command is processed normally

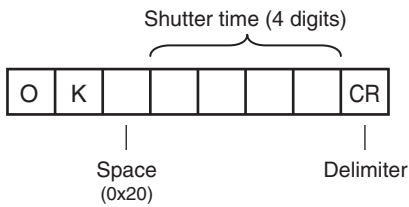

When the command is not processed normally

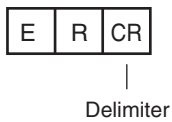

##### <Parameter Description>

Exposure time	The exposure time is output as a 4 digit value in units of 1/100 ms. Example: When the exposure time is 5.47 ms OK 0547
---------------	---

### Set Shutter Time

This command sets the shutter time.

This command is only valid when the HDR function is OFF.

#### ● LASERTIME or LT

<Command Format>

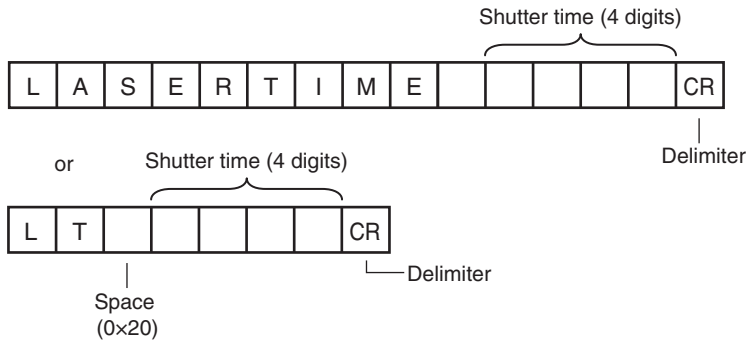

<Response Format>

When the command is processed normally

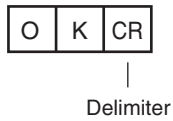

When the command is not processed normally

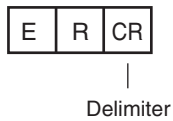

<Parameter Description>

Shutter time	Sets the exposure time in units of 0.01 ms. Enter a 4-digit value.
--------------	--



### Acquire gain

This command acquires the sensor gain.

This command is valid when the HDR function is OFF.

#### ● GAIN or GN

##### <Command Format>

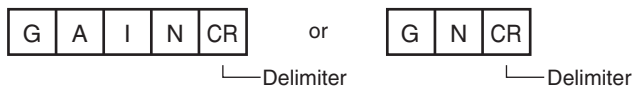

##### <Response Format>

When the command is processed normally

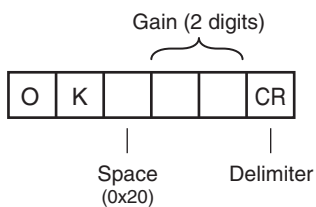

When the command is not processed normally

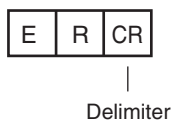

##### <Parameter Description>

Gain	The gain is output as a value from 16 to 64.
------	--

### Set Gain

Sets the sensor gain.

This command is only valid when the HDR function is OFF.

#### ● GAIN or GN

<Command Format>

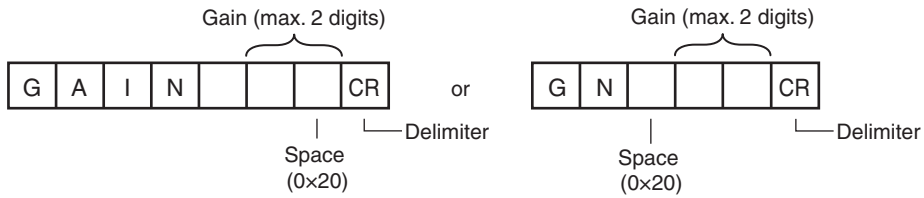

<Response Format>

When the command is processed normally

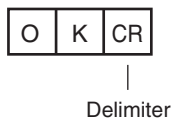

When the command is not processed normally

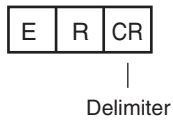

<Parameter Description>

Gain	Specifies the gain within the range 16 to 64.
------	---

### Acquire Brightness

This command acquires the sensor brightness.

This command is only valid when the HDR function is ON.

#### ● BRIGHTNESS or BN

##### <Command Format>

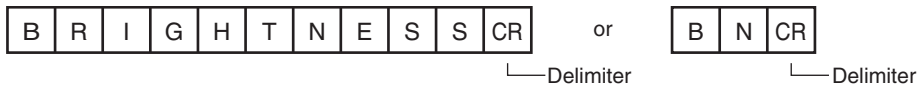

##### <Response Format>

When the command is processed normally

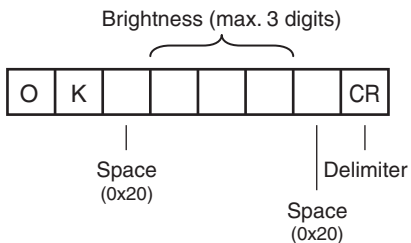

When the command is not processed normally

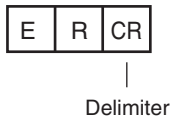

##### <Parameter Description>

Brightness	The brightness is output as a value from 1 to 100.
------------	--

### Set Brightness

This command sets the sensor brightness.

This command is only valid when the HDR function is ON.

#### ● BRIGHTNESS or BN

##### <Command Format>

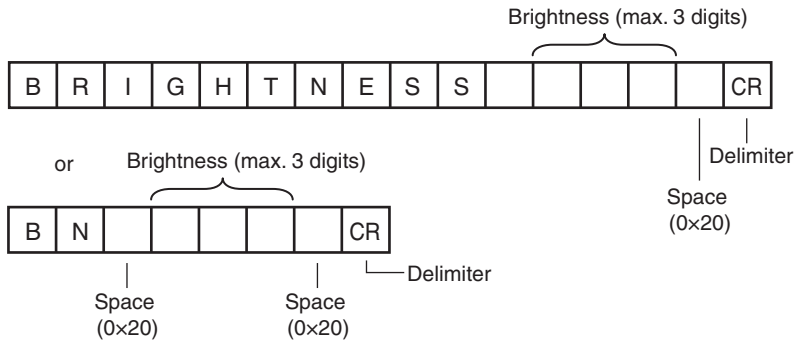

##### <Response Format>

When the command is processed normally

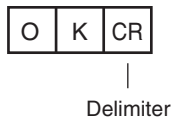

When the command is not processed normally

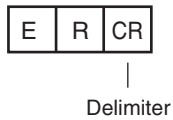

##### <Parameter Description>

Brightness	Sets the brightness as a value from 1 to 100.
------------	---

## Data Acquisition/Setting Commands

### ● FILTERDATA or FD

#### Acquire Filter Setting Information

This command acquires the filter type and filter size

#### <Command Format>

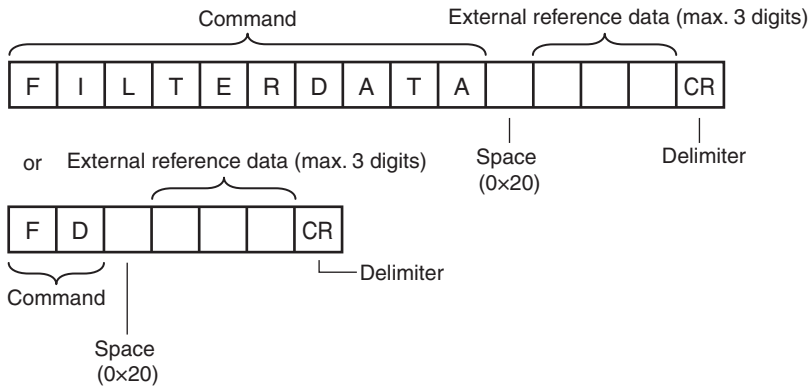

#### <Response Format>

When the Command Is Processed Normally

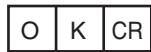
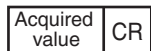

Delimiter

When the Command Is Not Processed Normally



Delimiter

#### <Parameter Descriptions>

External reference data	Specifies the external reference data number Refer to 10-2 External Reference Parameters (p. 168) for details.
Acquired value	Responds with specified filter setting. Refer to 10-2 External Reference Parameters (p. 168) for details.

## Set Filter Information

This command sets the filter type and filter size.

### <Command Format>

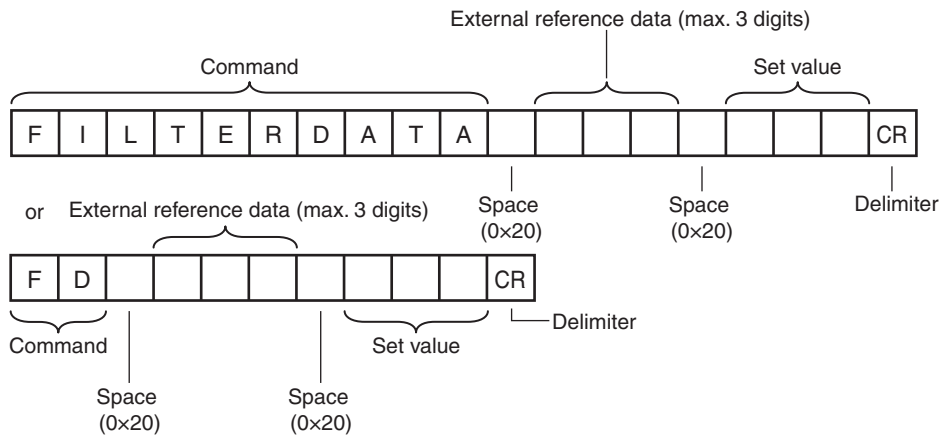

### <Response Format>

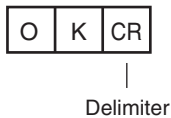

When the Command Is Processed Normally

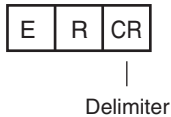

When the Command Is Not Processed Normally



### <Parameter Descriptions>

External reference data number	Specifies the external reference data number.  Refer to <i>10-2 External Reference Parameters</i> (p. 168) for details.
Setting	Specifies the set value.  Refer to <i>10-2 External Reference Parameters</i> (p. 168) for details.

● ITEM DATA or ID

Acquire Inspection Item Data

This command acquires the parameters and measurement values of the specified inspection item.

<Command Format>

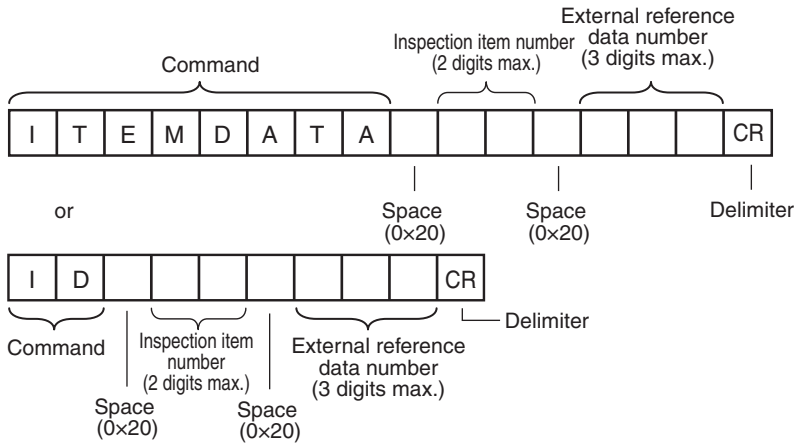

<Response Format>

When the Command Is Processed Normally

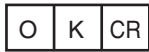



Delimiter

When the Command Is Not Processed Normally



Delimiter

<Parameter Descriptions>

Inspection item number	Specifies the inspection item number. (0 to 31)
External reference data number	Specifies the external reference data number. (0 to 999)  Refer to 10-2 External Reference Parameters (p. 168) for details.
Acquired value	Returns the data for the specified inspection item.  Refer to 10-2 External Reference Parameters (p. 168) for details.

## Set Inspection Item Data

This command sets the parameters and measurement values of the specified inspection item.

### <Command Format>

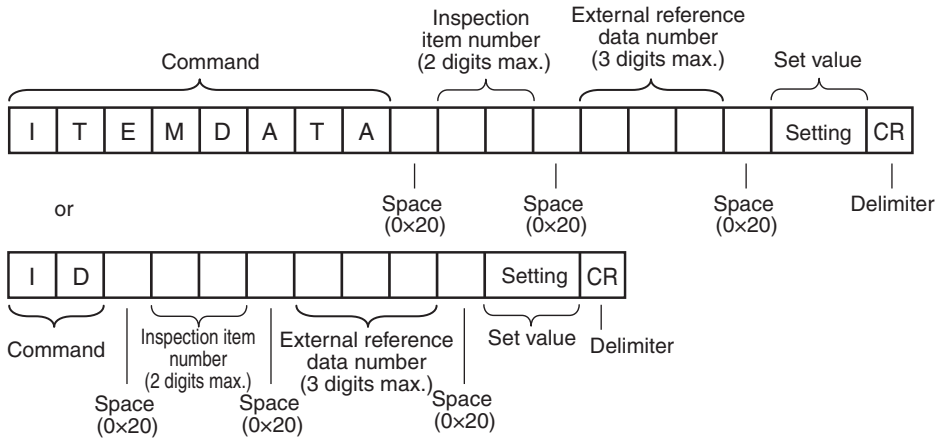

### <Response Format>

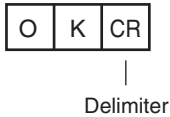

When the Command Is Processed Normally



When the Command Is Not Processed Normally



### <Parameter Descriptions>

Inspection item number	Specifies the inspection item number. (0 to 31)
External reference data number	Specifies the external reference data number. (0 to 999)  Refer to <i>10-2 External Reference Parameters</i> (p. 168) for details.
Acquired value	Returns the data for the specified inspection item.  Refer to <i>10-2 External Reference Parameters</i> (p. 168) for details.



● ITEMDATA2 Command or ID2

Acquire Inspection Item Text String Data

This command acquires the text string data of the specified Inspection Item.

<Command Format>

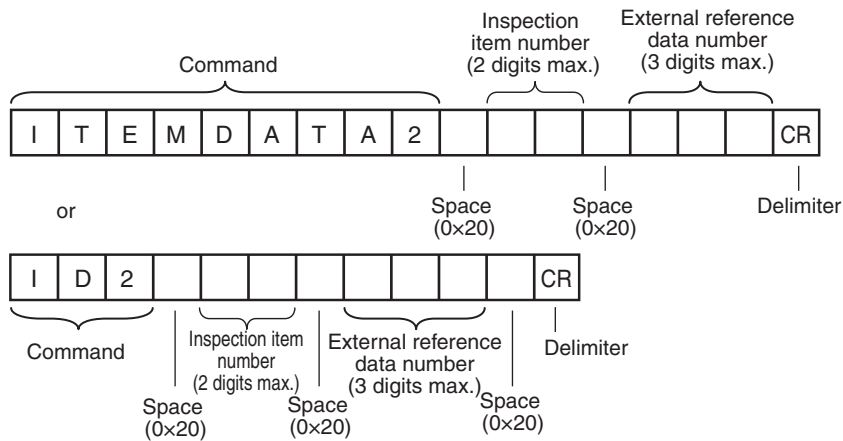

<Response Format>

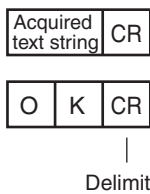

When the Command Is Processed Normally



When the Command Is Not Processed Normally



<Parameter Descriptions>

Inspection Item number	Specifies the Inspection Item number. (0 to 31)
External reference data number	Specifies the external reference data number. (0 to 999)  Refer to <i>10-2 External Reference Parameters</i> (p. 168) for details.
Acquired text string	Responds with the text string data of the specified Inspection Item.  Refer to <i>10-2 External Reference Parameters</i> (p. 168) for details.

## Setting Acquisition Commands

### ● VERGET

#### Acquire Software Version

This command acquires the version information of the Sensor software.

#### <Command Format>

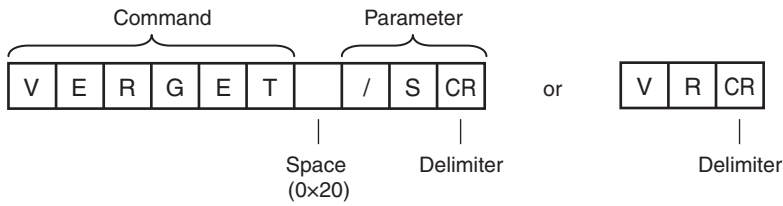

#### <Response Format>

When the Command Is Processed Normally

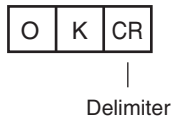
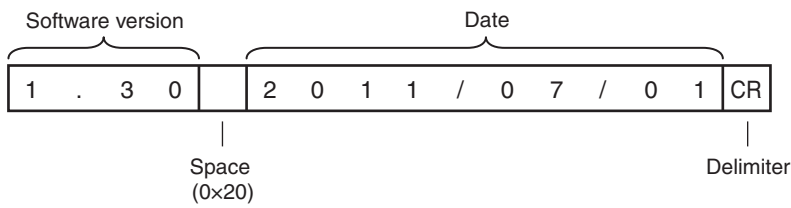

When the Command Is Not Processed Normally

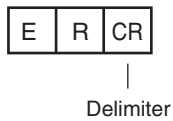

#### <Parameter Descriptions>

Software version	Returns the software version. Example: When the software version is 1.30, the response is 1.30.
Date	Returns the date. Example: When the date is 01 July 2011, the response is 2011/07/01.

### Acquire Sensor Model

This command acquires the Sensor model.

#### <Command Format>

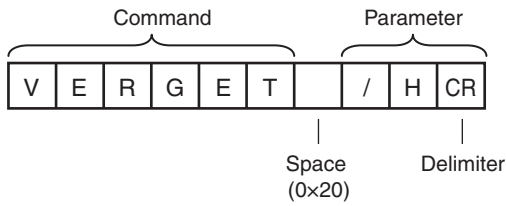

#### <Response Format>

When the Command Is Processed Normally

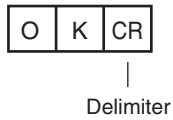
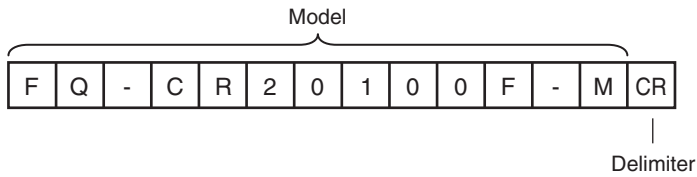

When the Command Is Not Processed Normally

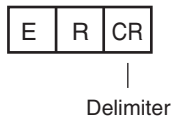

#### <Parameter Descriptions>

Model	Returns the model. Example: When the model is FQ-CR20100F-M, the response is FQ-CR20100F-M.
-------	--

● ERRGET

Acquire Error Information

This command acquires the latest error code from the Sensor.

<Command Format>

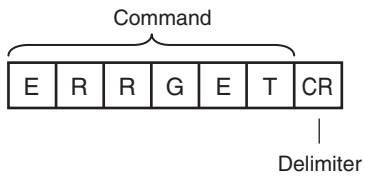

<Response Format>

When the Command Is Processed Normally

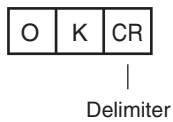
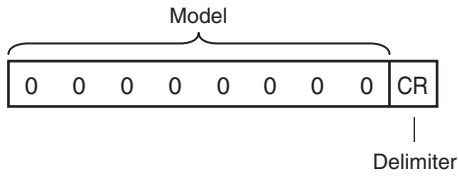

When the Command Is Not Processed Normally

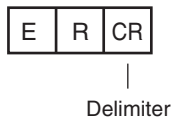

<Parameter Descriptions>

Error code	Returns the latest error code. If there is no error history, the response is 00000000.  Refer to 9-1 Error Table (p. 154) for details.
------------	--

### Save All Sensor Information

This command saves all sensor information, including scene data and system data in the flash memory inside the sensor.

#### ● SAVEALLDATA or SV

<Command Format>

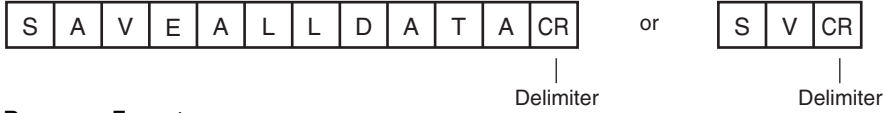

<Response Format>

When the Command Is Processed Normally

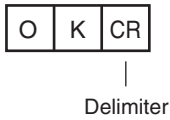

When the Command Is Not Processed Normally

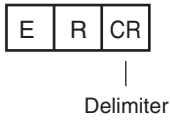

## Utility Commands

### ● CLRMEAS

#### Clear Measurement Values

This command clears the measurement values.

<Command Format>

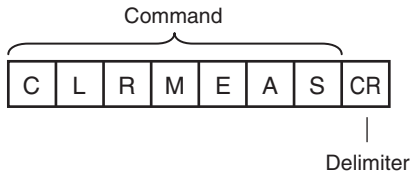

<Response Format>

When the Command Is Processed Normally

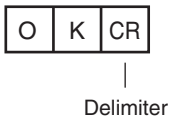

When the Command Is Not Processed Normally

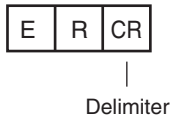

● CLRERR

Clear Errors

This command clears the error output status (error output and error indicator).

<Command Format>

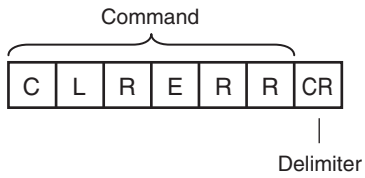

<Response Format>

When the Command Is Processed Normally

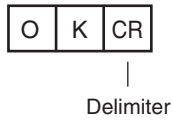

When the Command Is Not Processed Normally

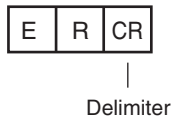

● RESET

Restarts the Sensor.

This command restarts the Sensor.

<Command Format>

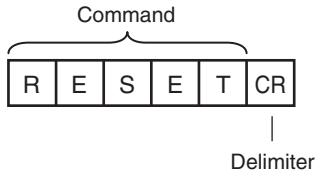

<Response Format>

When the Command Is Processed Normally

If process is completed normally, the Sensor is restarted. There is therefore no response.

When the Command Is Not Processed Normally

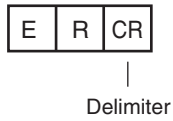



## Communications Example

An example of the communications log when a computer is connected and communications is performed with a no-protocol command from a terminal application is shown below.

Example 1: Changing Scenes (Scene number 1 is specified.)

```
S_1
  |
  +-----> [Space]
OK
```

Example 2: Acquiring inspection item data (Acquires the judgement result for a 2D-code registered to inspection item 10.)

```
ITEMDATA_10_0
  |
  +-----> [Space]
0
OK
```

Example 3: Measurement when Ethernet Output Is Not Set

```
M
OK
```

Example 4: Measurement when Ethernet Output Is Set

```
M
OK
    1.0000      0.0000      0.0000      306.0000
M
OK
    2.0000      0.0000      0.0000      0.0000
```



# Troubleshooting

---

9-1 Error Table.....	154
9-2 Basic Troubleshooting.....	156



# 9-1 Error Table

## Error History

Up to 10 errors will be stored in the error history in the Sensor or Touch Finder.

This section describes the causes of and measures for errors that are stored in the error history.

### Errors Stored in the Error History

Error in error history	Cause	Points to check	Measures to perform
TRIG input error  ERR (Error code: 01040302)	The TRIG signal was input while the BUSY signal was ON.	<ul style="list-style-type: none"> <li>• Check the program in the PLC or other host to see if an interlock or similar measure has been implemented.</li> <li>• If a relay or other device with contacts is being used as the input device, see if chattering has occurred.</li> </ul>	<ul style="list-style-type: none"> <li>• Program interlocks to control the TRIG and IN5 input signals so that they do not turn ON while the BUSY signal is ON.</li> <li>• Switch from a device with contacts (e.g., relay) to a device without contacts (e.g., SSR or PLC transistor output).</li> </ul>
IN input error  ERR (Error code: 11020900)	The IN5 signal was input while the BUSY signal was ON.		
Scene data error  ERR (Error code: 01030800)	The scene could not be switched for an input signal from an external device.	---	The scene data to be switched to is corrupted. Reset the scene data from the beginning.
Logging error (Error code: 02160702, 02160703)	All of the data was not saved when logging data to a file.	Check to see if the BUSY output parameter is set to <i>Measurement</i> .	Set the BUSY output parameter to <i>Data logging</i> or <i>Image logging</i> .
SD card output error (Error code: None)	A write to the SD card failed.	Check to see if the SD card is locked. Check to see if there is sufficient space available on the SD card.	Unlock the SD card. Delete unnecessary files from the SD card.

 ERR If an error that is indicated by this icon occurs, the ERROR operation indicator will light and the ERROR signal will turn ON.

## Checking the Error Histories

### • Checking the History of Errors That Have Occurred in the Sensor

- ▶  (Setup Mode) – [Sensor settings] – [Error history] – [View history]

Errors will be displayed in order with the most recent ones on top.

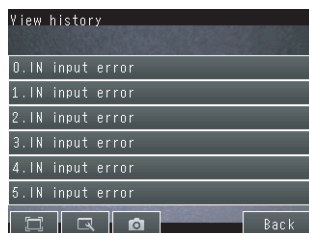

### • Checking the Log of Errors That Have Occurred in the Touch Finder

- ▶  (Setup Mode or Run Mode) – [TF settings] – [Error history] – [View history]

## Clearing the Error Histories

### • Deleting the History of Errors That Were Detected in the Sensor

- ▶  (Setup Mode) – [Sensor settings] – [Error history] – [Delete history]

### • Deleting the History of Errors That Were Detected in the Touch Finder

- ▶  (Setup Mode or Run Mode) – [TF settings] – [Error history] – [Delete history]

#### Note

Refer to the following information for the measures to take when errors occur.

 Errors Stored in the Error History: p. 154

## Checking the Latest Error Information (for No-protocol Connection to Ethernet)

The error code of the latest error can be acquired as a response using the error information acquisition command (ERRGET).

- Error Codes: p. 154
- Error Information Acquisition Command (ERRGET): p. 146

## Error Messages

If an error occurs while making settings on the Touch Finder, an error message will appear on the display. For these errors, the ERR indicator on the Sensor will not light, the ERROR signal will not be output, and the error will not be recorded in the error history. Follow the instructions that are given in the error message.

If the following messages appear, the hardware may be faulty. Contact your OMRON representative.

- System error.
- Application system error. Please reboot.
- Failed to startup.

# 9-2 Basic Troubleshooting

Problem	Measures to perform	Reference
The Sensor or Touch Finder will not start.	Check the power supply capacity to see if it is sufficient.	---
The Sensor cannot be detected.	Check the Ethernet cable to see if it is connected correctly.	---
	Check the Ethernet settings to see if they are correct between the devices.	p. 31
	Check if there are any Sensors that were not detected by the Sensor connection check.	p. 165
	Check the communications cable to see if it is disconnected.	---
	Check the switching hubs to see if any of them are faulty. (If switching hubs are used.)	---
The results display is not updated.	Check to see if the TRIG signal is being correctly input to the Sensor.	p. 75
	Check to see if the most recent NG result is being displayed.	p. 14
Updating the results display is slow.	If other devices are connected to the same network as the Sensor, disconnect the other devices from the network and check the update speed. If the update speed returns to normal, check the specifications of the disconnected devices and take suitable measures.	---
	If there are power lines running in parallel with the Ethernet cable or if there are inverters or other sources of noise near the communications cable, separate the communications cable from them and check the update speed. Noise may be adversely affecting the communications response.	---
Data is not logged properly.	Check to see if the logging setting in the Sensor are correct.	p. 76
	If logging to an SD card is not possible, check the available space on the SD card and check to see if the SD card is write-protected.	p. 84
The ERROR indicator lights.	Check the error history to see what error has occurred and take suitable measures.	p. 154
The image brightness does not stabilize.	Turn ON the brightness correction mode. When the Brightness Correction Mode is ON, the timing when images are taken changes. Check that the images of the measured objects taken when the Brightness Correction Mode is ON are appropriate.	p. 39

# Appendices

---

<b>10-1 Menu Tables .....</b>	<b>158</b>
<b>10-2 External Reference Parameters .....</b>	<b>168</b>
<b>10-3 Specifications and Dimensions .....</b>	<b>170</b>
<b>10-4 Updating the Software .....</b>	<b>180</b>

# 10-1 Menu Tables

## Image Tab Page

Menu command		Description	Setting range	Data	Reference		
Camera setup	Focus	The value shown here is used as a reference when adjusting the focus with the focus adjustment screw.	---	---	p. 35		
	HDR OFF	Shutter speed	Sets the shutter speed of the sensor.	1/10 to 1/32258, Default: 1/10	Scene	p. 36	
		Brightness correction	Use to stabilize the brightness.	ON, OFF (default)	Scene	p. 156	
		Gain		Sets the sensor gain.	16 to 64, Default: 16	Scene	p. 36
			Brightness correction	Use to stabilize the brightness.	ON, OFF (default)	Scene	p. 156
		HDR	Reduces reflected light and bright/dark contrast.	OFF (default), Level 1 to Level 4	Scene	p. 37	
		Partial input	Reduces the image scanning range.	752 × 8 to 752 × 480	Scene	p. 56	
	Lighting control	Turns sensor lighting on or off.	ON (default), OFF	Scene	p. 89		
	HDR ON	Brightness	Adjusts the brightness of the image.	AUTO, 1 to 100	Scene	p. 36	
		HDR	Reduces reflected light and bright/dark contrast.	OFF (default), Level 1 to Level 4	Scene	p. 37	
		Brightness correction	Use to stabilize the brightness.	ON, OFF (default)	Scene	p. 156	
		Partial input	Reduces the image scanning range.	752 × 8 to 752 × 480	Scene	p. 56	
		Lighting control	Turns sensor lighting on or off.	ON (default), OFF	Scene	p. 89	
	Trigger setup	Trigger delay	Adjusts the time until the Camera shutter opens after the trigger signal is received.	0 to 163 ms (default: 0)	System	p. 41	
Filter Setup		Sets the filter region and type.			p. 44		
	Filter region	Sets the filter region.	---	Scene			
	Select Filter	Sets the filter.	Filter 1 to Filter 3	Scene			
	Filter Type	Sets the filter type.	Smooth, Dilate, Erosion, Median, None (default)	Scene			
	Filter Size	Sets the filter size	3 × 3 (default), 5 × 5	Scene			



## Inspect Tab Page

Menu command		Description	Setting range	Data	Reference	
Inspection	Item selected	Add item	Used to add, modify, delete, copy, or change the name of an inspection item.	2D code	---	p. 47
		Modify		---	---	p. 48
		Delete		---	---	p. 48
		Copy		---		
		Rename		15 alphanumeric characters	---	
Settings	 Insp. region	Changes the inspection region.	---	Scene	p. 50	
Details	Code type	Selects the type of code that is scanned.	DataMatrix, QR Code, Auto (default)	Scene	p. 51	
	Auto length	Sets whether the code length is automatically acquired.	OFF, ON (default)	Scene	p. 51	
	Reverse	Sets Normal/Reverse.	Normal, Reverse, Auto (default)	Scene	p. 51	
	Code color	Sets the code color.	Black, White, Auto (default)	Scene	p. 51	
	Fast mode	Specifies whether fast mode is set. When fast mode is set, the scanning time is shorter.	OFF (default), ON	Scene	p. 51	
	Shape (Data Matrix)	Sets the code shape.	Square, Rectangle, Auto (default)	Scene	p. 51	
	QR Code Model (QR Code)	Sets the QR code model.	Model 1, Model 2, Auto (default)	Scene	p. 51	
	Error Correction Level (QR Code)	Sets the error correction level (ECC level).	L (7%), M (15%), Q (25%), H (30%), Auto (default)	Scene	p. 51	
Cell	Sets the number of cells of the code.	QR Code 21 × 21, 25 × 25, 29 × 29, 33 × 33, 37 × 37, 41 × 41, 45 × 45, 49 × 49, 53 × 53, 57 × 57, Auto DataMatrix (Square) 10 × 10, 12 × 12, 14 × 14, 16 × 16, 18 × 18, 20 × 20, 22 × 22, 24 × 24, 26 × 26, 32 × 32, 36 × 36, 40 × 40, 44 × 44, 48 × 48, 52 × 52, 64 × 64, Auto DataMatrix (Rectangle) 8 × 18, 8 × 32, 12 × 26, 12 × 36, 16 × 36, 16 × 48, Auto	Scene	p. 51		
Retry details	Max Count (Normal retry)	Sets the number of retries.	0 to 8, Default: 4	Scene	p. 92	
	Interval (Normal retry)	Sets the retry interval (msec).	0 to 8, Default: 100	Scene	p. 92	
	Brightness step (Exposure retry)	Sets the exposure time step (msec).	Brightness step: 1 to 20, Default 2 shutter speed step: 0.01 to 1.00 (Default: 1.00)	Scene	p. 93	
	Increment count (Exposure retry)	Sets the increment count for the brightness (shutter speed) step.	0 to 10, 2 (default)	Scene	p. 93	
	Decrement count (Exposure retry)	Sets the decrement count for the brightness (shutter speed) step.	0 to 10, 2 (default)	Scene	p. 93	

## In/Out Tab Page

Menu command		Description	Setting range	Data	Reference		
Log setting	Statistical data	Sets whether to record the number of measurements and the number of NG overall judgements.	ON (default) or OFF	System	p. 80		
	Image logging	Sets the parameter to log measurement image data.	All, Only NG, or None (default)	System	p. 76 p. 80		
	Data logging	Sets the parameter to log measurement data from inspection items.	All (default), Only NG, or None (default)	System			
	Delete Log	Resets the log data without turning OFF the power supply.	---	---	p. 80		
I/O setting	I/O terminals	Output	OUT0	Used to assign output signals to OUT0, OUT1, and OUT2. OR (Total judgement) (default) or OR0 (Item0 judgement) to OR31 (Item31 judgement)	System	p. 102	
			OUT1		BUSY (default) or OR0 (Item0 judgement) to OR31 (Item31 judgement)		System
			OUT2		ERROR (default) or OR0 (Item0 judgement) to OR31 (Item31 judgement)		System
		Output polarity	Sets the ON condition for the OR signal.	OK: ON or NG: ON (default)	System	p. 106	
		Output mode	Sets the output timing for the judgement result.	One-shot output or Level output (default)	System	p. 104	
		Output delay	When one-shot output mode is selected, this parameter sets the delay from when measurement processing is completed until when the OR signal turns ON.	0 to 1,000 ms (default: 0 ms)	System		
		Output time	When one-shot output mode is selected, this parameter sets the time that the OR signal is ON.	0 to 1,000 ms (default: 5 ms)	System		
		BUSY output	Specifies when to turn OFF the BUSY signal after starting measurement processing.	Measurement (default), Data logging, Image logging, or Result display	System	p. 78	
		BUSY polarity	Sets the ON condition for the BUSY signal output.	BUSY: ON (default), READY: ON	System	p. 106	
		Output trigger error	Sets whether an error is output if a trigger is received while BUSY.	ON (default), OFF	System	p. 107	
	Input	Input mode	Specifies whether to use functions other than scene switching for external parallel commands.	Standard mode (default) or Expanded mode	System	p. 107	

Menu command		Description	Setting range	Data	Reference	
I/O setting	Ethernet [MENU]	Output data set	---	Data 0 to data 31	Scene	p. 120
		Settings	Sets data to output to selected data number.	Text strings of the set inspection items.	Scene	
		Rename	Changes the name of the selected data number.	The name can be changed to a name with up to 15 alphanumeric characters.	---	
		Copy	Copies the contents registered in the selected data number to another data number.	---	---	
		Delete	Clears the content of the selected data number.	---	---	
	Output character set		---	Inspection Items 0 to 31	Scene	
	String output on/off		Selects whether the scanned string is output by Ethernet.	ON, OFF (default)	Scene	
	Partial output on/off		Selects whether an output range is specified.	ON, OFF (default)	Scene	
	Output string setup		Sets the starting and ending digits of output.	1 to 1024	Scene	
	NG String output on/off		Selects whether an NG scan result is output by Ethernet.	ON, OFF (default)	Scene	
	Output form		---	---	---	p. 122
	Output form		Selects the format of the data to be output.	ASCII (default) or Binary	Scene	
	When output format is ASCII	Digits of integer	Sets the digits of the integer part, including the sign. However, + is not output for positive numbers. Example: Setting 4-digit data: -5963 is output as -999.	1 to 10 (Default: 6)	Scene	
		Digits of decimal	Sets the output digits for the decimal part. If it is set to 0, the decimal part is rounded off before the data is output.	0 to 4 (default: 4)	Scene	
		Minus	Selects what to display as the sign when the number is negative.	- (Default) or 8	Scene	
0 suppress		Selects the method to adjust unused digits on the left in output data. ON: Zeros are inserted for unused digits. OFF: Spaces are inserted for unused digits. Example: The following examples are for when five integer digits and three decimal digits are set and the data is 100.000. ON: 00100.000 OFF: _100.000 (The underscore indicates a space.)	ON or OFF (default)	Scene		
Output form	When Output Format Is ASCII	Field separator	Selects the separator to use between output data.	None (default), comma, tab, space, CR, LF, or CR+LF	Scene	p. 130
	When output format is Binary	Record separator	Selects the separator to use between sets of output data.	None (default), comma, tab, space, CR, LF, or CR+LF	Scene	p. 122
		Decimal output form	Selects the numerical expression for binary output. Fixed-decimal-point data is multiplied by 1,000 and the result is output.	Floating-point decimal or fixed decimal (default)	Scene	p. 123
I/O monitor	I/O monitor	Used to check I/O connections.	---	---	p. 75	

## Test Tab Page

Menu command	Description	Setting range	Data	Reference
Continuous test	Used to check the individual judgement results for the inspection items and to adjust the judgement parameters.	---	---	p. 54
Graphic	Displays the input image.			
Graphics + Details	Displays the inspection item individual judgement results and measurement values.			
All results/Region	Displays the inspection item individual judgement results for all inspection items.			p. 57
Trend Monitor	Displays the individual judgement results saved in the Sensor in a trend monitor.			p. 54
Histogram	Displays the individual judgement results saved in the Sensor in a histogram.			
 Auto display (trend monitor and histogram only)	Same as the trend monitor and histogram for [Run] Mode.		---	p. 64 p. 65
Display range (trend monitor and histogram only)				
Number of data (trend monitor only)				p. 64
Number of data (histogram only)				p. 65
Save data	Saves scene data and system data.	---	---	p. 58

## Run Tab Page (from Setup Display)

Menu command	Description	Setting range	Data	Reference
Switch to Run mode	Switches to Run Mode.	---	---	p. 60



## Tool

### Setup Mode



Menu command	Description	Setting range	Data	Reference
Select scene		---	---	p. 70
Select	Switches to a registered scene.	---		
Rename	Used to delete, copy, or change the name of a scene.	15 alphanumeric characters		
Copy		---		
Clear				

Menu command		Description	Setting range	Data	Reference		
Save to file	Setting	Scene data	Saves scene data with an SCN file name extension.	---	---	p. 83	
		Scene group data	Saves all scene data with an SGP file name extension.				
		Sensor system data	Saves system data with an SYD file name extension.				
		All Sensor data	Saves all Sensor data with a BKD file name extension.				
		Touch Finder data	Saves Touch Finder data with an MSD file name extension.				
Logging	Statistical data	Saves statistical data with a CSV file name extension.	---	---	p. 76		
	Logging image	Saves image data with an IFZ file name extension.					
	Logging data	Saves measurement data with a CSV file name extension.					
Load from file	Scene data	Loads scene data.	---	---	p. 83		
	Scene group data	Loads scene group data.					
	Sensor system data	Loads system data.					
	All Sensor data	Loads all Sensor data.					
	Touch Finder data	Loads Touch Finder data.					
Sensor settings	Information		Used to check the Sensor information.	---	---	p. 90	
	Model		Used to check the model and software version of the connected Sensor.				System
	Version						
	Name		Displays the name of the connected Sensor.				
	MAC address		Used to check the MAC address of the connected Sensor.	---			
		Rename	Used to change the name of a connected Sensor.	15 alphanumeric characters max.	---	p. 90	
		Memory state	Used to check the status of Sensor memory.	---	---	p. 90	
Error history	View history	Displays a history of errors that have occurred in the Sensor.	---	System	p. 154		
	Delete history	Deletes the error history.		---	---	p. 155	

Menu command		Description	Setting range	Data	Reference	
Sensor settings	Startup settings	Startup mode	Sets whether the startup scene number is set manually.	ON or OFF (Scene number when settings were saved is startup scene number.)	System	p. 71
		Startup scene	Set the scene number to use at startup.	Standard models: 0 to 31, Single-function models: 0 to 7, Default: 0	System	
	Password settings	Password ON/OFF	Enables (ON) or disables (OFF) the password.	OFF (default) or ON	System	p. 86
		Enter password	Sets a password.	15 characters max.	System	
	Timeout		Sets the timeout time for inspection (msec).	100 to 9999	System	p. 90
	Retry details		Sets the inspection retry type.	Normal retry, Exposure retry, Scene retry, Trigger retry, None (default)	System	p. 91
Network settings	Ethernet					p. 31
	Auto		Selects whether to use the automatic IP address setting method.	ON (default) or OFF	System	
	IP address		Enter the IP address of the Sensor. (Enabled when automatic setting is OFF.)	a.b.c.d a: 1 to 223 b: 0 to 255 c: 0 to 255 d: 2 to 254 (Default: 10.5.5.100)	System	p. 31
	Subnet mask		Inputs the subnet mask. (Enabled when automatic setting is OFF.)	0.0.0.0 to 255.255.255.255 (Default: 255.255.255.0)	System	p. 31
Initialize		Initializes the Sensor settings and saved data.	---	---		p. 89
Restart		Restarts the Sensor	---	---		
Update		Updates the Sensor system to the most recent data.	---	---	p. 180	
TF settings	Information		Used to check the Touch Finder information.	---	System	p. 90
	Model		Used to check the Touch Finder model.	---	---	---
	Version		Used to check the software version of the Touch Finder.	---	---	p. 90
	MAC address		Used to check the MAC address of the Touch Finder.	---	---	
	Memory state		Used to check the Touch Finder memory state.	---	---	p. 90
	Error history	View history	Displays a history of errors that have occurred in the Touch Finder.	---	System	p. 154
		Delete history	Deletes the error history.	---	---	
	Battery level		Used to check the battery level.	---	---	p. 90
	File format		Used to set the output format for output log data to a file.	---	---	p. 77
	Field separator			None, Comma (default), Tab, Space, Colon, Semicolon, CR, or CR+LF	---	
Decimal symbol			None, Point (default), or Comma	---		
Record separator			None, Comma, Tab, Space, Colon, Semicolon, CR, or CR+LF (default)	---		







Menu command		Description	Setting range	Data	Reference	
TF settings	SD card	SD card information	Displays the capacity and remaining memory in the SD card.	---	---	p. 85
		Format	Formats an SD card.	---	---	p. 85
	Startup display	Display pattern	Sets the display to use in Run Mode.	Graphic, Graphics + Details, All results/Region, Statistical data, Trend monitor, Histogram	System	p. 62
		Display update mode	Sets the image to update in Run Mode.	Latest image, Last NG image		
	LCD backlight	Brightness	Sets the brightness.	0 to 5	System	p. 74
		ECO mode	Enables (ON) or disables (OFF) ECO Mode.	ON, OFF	System	p. 74
	Ethernet			---	System	p. 31
		IP address	Inputs the IP address of the Touch Finder.	a.b.c.d a:1 to 223 b: 0 to 255 c: 0 to 255 d: 0 to 255 (Default: 10.5.5.100)	System	p. 31
		Subnet mask	Inputs the subnet mask.	0.0.0.0 to 255.255.255.255 (Default: 255.255.255.0)		p. 31
		Search unreachable sensors	Displays the IP address if the same IP address is used for more than one Sensor or if there is Sensor that is not in the subnet. You can change this IP address and subnet mask. This setting is valid only when automatic setting of the Sensor's IP address is OFF.	---		---
	Language		Changes the language to display on the Touch Finder.	English, German, French, Italian, Spanish, Traditional Chinese, Simplified Chinese, Korean, or Japanese (The default language is selected at startup.)	System	p. 89
	Time settings		Used to set the current date and time.	Default: Selected at startup.	System	p. 89
	Touch screen calib		Used when there is an offset between the touch screen positions and pointers.	---	---	p. 90
	Initialize		Initializes the Touch Finder settings.	---	---	p. 89
Restart		Restarts the Touch Finder.	---	---	p. 89	
Update		Updates the Touch Finder system to the most recent data.	---	---	p. 180	

## Run Mode

Menu command		Description	Setting range	Data	Reference	
Select display	Graphic	Displays the input image.	---	---	p. 62	
	Graphics + Details	Displays the inspection item individual judgement results and measurement values.		---		
	Statistical data	Displays the total number of measurements and the total number of NG overall judgements and the NG ratio from when the power supply was turned ON.		---		
	All results/Region	Displays the inspection item individual judgement results for all inspection items.		---		
	Trend Monitor	Displays the individual judgement results saved in the Sensor in a trend monitor.		---		p. 64
	Histogram	Displays the individual judgement results saved in the Sensor in a histogram.		---		p. 65
	Auto display (trend monitor and histogram only)	Automatically sets the display range according to the measurement results.	OFF or ON (default)	---	p. 64, p. 65	
	Display range (trend monitor and histogram only)	Changes the display range of measurement values.	-999,999,999 to 999,999,999	---	p. 64, p. 65	
	Number of data (trend monitor only)	Changes the number of displayed measurement values.	200, 400, or 1,000 (default: 200)	---	p. 64	
	Number of data (histogram only)	Changes the number of displayed measurement values (i.e., the vertical display range of the histogram).	5 to 1,000	---	p. 65	
	Clear results (graphic or graphic + details list)	Clears the measurement results of the inspection items.	---	---	---	
	Delete status (total data)	Clears the total results of the inspection items.	---	---	---	
Logging	Image logging	Starts and stops logging in external memory.	ON: Start or OFF: Stop	---	p. 76	
	Data logging		ON: Start or OFF: Stop	---		
TF settings		The same as for Setup Mode. (This does not apply to the PC Tool.) The resolution of the measurement image can be set on the PC Tool.	---	---	p. 89	
Sensor setting		Switches to Setup Mode.	---	---	p. 60	
Sensor monitor	Multi sensor	Simultaneously displays the images for multiple connected Sensors.	---	---	p. 62	
	NG sensor	From multiple connected Sensors, displays the image of only the Sensors with NG results.	---	---		
Switch sensor	Select	Switches to the selected Sensor.	---	---	---	
	Connections			Displays the name of the Sensor detected by the Touch Finder and the connection status.		
		Auto connect		Automatically detects and connects the Sensors that are connected.		



## Common Menu Commands

Menu command	Description	Setting range	Data	Reference
 Only-image Button	Hides text and displays only the image.	---	---	p. 74
Display Button	 Zoom-in Button	Enlarges the image display.	---	p. 72
	 Zoom-out Button	Reduces the image display.		
	 FIT Button	Fits the image to the display size.		
	Display Button 	Changes the image display method.	Setup Mode: Camera (Live, Freeze) Log, or File Run Mode: Latest image or Last NG image	---
 Capture Button	Used to capture the current display and save it in external memory, e.g., an SD card.	---	---	p. 87

# 10-2 External Reference Parameters

## 2D Codes

External reference number	Data name	Set/acquired	Data range	Default	Text string assigned to Ethernet output setting	Logged
0	Judgment	Acquired only	-2: No judgment (not inspected) 0: Judgment result OK -1: Judgment result NG -13: Teaching not executed error -14: Figure not registered error -15: Outside region error -16: Inspection timeout error	-2	JG	---
5	Num. of char.	Acquired only	0 to 1024	0	N	---
6 <sup>1</sup>	Characters	Acquired only	Text string	---	---	---
8	Cell Recog. Rate	Acquired only	0 to 100	0	E	Logged
9	Contrast	Acquired only	0 to 100	0	C	---
10	Focus	Acquired only	0 to 100	0	F	---
120	Code type	Set/acquired	0: Auto 1: DataMatrix 2: QR Code	0	---	---
121	Code color	Set/acquired	0: Auto 1: Black 2: White	0	---	---
122	Cell (DataMatrix Square)	Set/acquired	0: Auto 1: 10 × 10 2: 12 × 12 ... 16: 64 × 64	0	---	---
123	Cell (DataMatrix Rectangle)	Set/acquired	0: Auto 1: 8 × 18 2: 8 × 32 ... 16: 16 × 64	0	---	---
124	Cell (QR Code)	Set/acquired	0: Auto 1: 21 × 21 2: 25 × 25 ... 10: 57 × 57	0	---	---
127	Size	Set/acquired	50 to 480	480	---	---
128	Reverse	Set/acquired	0: Auto 1: Normal 2: Reverse	0	---	---
129	QR Code Model	Set/acquired	0: Auto 1: Model 1 2: Model 2	0	---	---
130	Error Correction Level	Set/acquired	0: Auto 1: M (15%) 2: L (7%) 3: H (30%) 4: Q (25%)	0	---	---
132	Fast mode	Set/acquired	0: OFF 1: ON	0	---	---
133	String output on/off	Set/acquired	0: OFF 1: ON	0	---	---
134	Partial output on/off	Set/acquired	0: OFF 1: ON	0	---	---

External reference number	Data name	Set/acquired	Data range	Default	Text string assigned to Ethernet output setting	Logged
135	Output end digit	Set/acquired	1 to 1024	1024	---	---
136	Output starting digit	Set/acquired	1 to 1024	1	---	---
137	Auto length	Set/acquired	0: OFF 1:ON	1	---	---
138	NG String output on/off	Set/acquired	0: OFF 1: ON	0	---	---

\*1 To acquire the detected text string, use the ITEMDATA2 command.

## Filter

External reference number	Data name	Set/acquired	Data range	Default	Text string assigned to Ethernet output setting	Logged
0	Judgment	Acquired only	-2: No judgment (not inspected) 0: Judgment result OK -1: Judgment result NG -13: Teaching not executed error -14: Figure not registered error -15: Outside region error	-2	---	---
120	1st Filter Type	Set/acquired	0: None 1: Smooth 2: Dilate 3: Erosion 4: Median	0	---	---
121	1st Filter Size	Set/acquired	1: 3 × 3 2: 5 × 5	1	---	---
123	2nd Filter Type	Set/acquired	0: None 1: Smooth 2: Dilate 3: Erosion 4: Median	0	---	---
124	2nd Filter Size	Set/acquired	1: 3 × 3 2: 5 × 5	1	---	---
126	3rd Filter Type	Set/acquired	0: None 1: Smooth 2: Dilate 3: Erosion 4: Median	0	---	---
127	3rd Filter Size	Set/acquired	1: 3 × 3 2: 5 × 5	1	---	---

# 10-3 Specifications and Dimensions

## Sensor

### Specifications

Item		Fixed Mount 2D Code Reader
Model	NPN	FQ-CR2□□□□-M
	PNP	FQ-CR25□□□□-M
Field of view		Refer to Table 1.
Installation distance		Refer to Table 1.
Minimum resolution		FQ-CR2□010F-M: 0.040 mm FQ-CR2□050F-M: 0.070 mm FQ-CR2□100F-M: 0.282 mm FQ-CR2□100N-M: 0.155 mm
Main functions	Inspection items	2D codes (DataMatrix (EC200), QR codes)
	Number of simultaneous measurements	32
	Number of registered scenes	32
Image input	Image filter	High dynamic range (HDR), polarizing filter (attachment), Smooth, Dilate, Erosion, Median
	Image elements	1/3-inch monochromatic CMOS
	Shutter	1/250 to 1/32,258
	Processing resolution	752 × 480
Lighting	Lighting method	Pulse
	Lighting color	White
Data logging	Measurement data	In Sensor: 1,000 items (If a Touch Finder is used, results can be saved up to the capacity of an SD card.)
	Images	In Sensor: 20 images (If a Touch Finder is used, images can be saved up to the capacity of an SD card.)
Measurement trigger		External trigger (single or continuous)
I/O specifications	Input signals	7 signals • Single measurement input (TRIG) • Control command input (IN0 to IN5)
	Output signals	3 signals • Control output (BUSY) • Overall judgement output (OR) • Error output (ERROR) Note: The three output signals can be allocated for the judgements of individual inspection items.
	Ethernet specifications	100Base-TX/10Base-T Numerical outputs and control commands are supported with no-protocol communications.
	Input specifications	Refer to Table 2.
	Output specifications	
	Connection method	Special connector cables Power supply and I/O: 1 cable (FQ-WD□□□) Touch Finder and computer: 1 cable (FQ-WN□□□)

Item		Fixed Mount 2D Code Reader
Indications		Judgement results indicator (color: orange), ERROR indicator (color: red), and BUSY indicator (color: green)
Ratings	Power supply voltage	20.4 to 26.4 VDC (including ripple)
	Insulation resistance	Between all lead wires and case: 0.5 MΩ (at 250 V)
	Current consumption	2.4 A max.
Environmental immunity	Ambient temperature range	Operating: 0 to 50°C Storage: -25 to 65°C (with no icing or condensation)
	Ambient humidity range	Operating and storage: 35% to 85% (with no condensation)
	Ambient atmosphere	No corrosive gas
	Vibration resistance (destruction)	10 to 150 Hz, single amplitude: 0.35 mm, X/Y/Z directions 8 min each, 10 times
	Shock resistance (destruction)	150 m/s <sup>2</sup> 3 times each in 6 direction (up, down, right, left, forward, and backward)
	Degree of protection	IEC 60529 IP67 (Except when Polarizing Filter Attachment is mounted.)
Materials		Sensor: PBT, PC, SUS Mounting Bracket: PBT Polarizing Filter Attachment: PBT, PC Ethernet connector: Oil-resistance vinyl compound I/O connector: Lead-free heat-resistant PVC
Weight		Depends on field of view and installation distance. Refer to Table 1.
Accessories		Mounting Bracket (FQ-XL)(1) Polarizing Filter Attachment (FQ-XF1) (1) Instruction Manual Member Registration Sheet
LED class <sup>*2</sup>		Risk Group 2

Table 1

NPN	PNP	Field of view (H×V) *1	Installation distance	Number of LEDs	Weight
FQ-CR20010F-M	FQ-CR25010F-M	7.5 × 4.7 to 13 × 8.2 mm	38 to 57 mm	4	200 g max.
FQ-CR20050F-M	FQ-CR25050F-M	13 × 8.2 to 53 × 33 mm	56 to 215 mm	4	
FQ-CR20100F-M	FQ-CR25100F-M	53 × 33 to 240 × 153 mm	220 to 970 mm	8	
FQ-CR20100N-M	FQ-CR25100N-M	29 × 18 to 300 × 191 mm	32 to 380 mm	8	

\*1: Tolerance: ±10% max.

\*2: Applicable standards: IEC62471-2

Table 2

Item	NPN	PNP
Input specifications	ON: Shorted to 0 V, or 1.5 V max. OFF: Open (leakage current: 0.1 mA max.)	ON: Shorted to power supply voltage, or power supply voltage -1.5 V max. OFF: Open (leakage current: 0.1 mA max.)
Output specifications	NPN open collector 30 VDC, 50 mA max., residual voltage: 1.2 V max.	PNP open collector 30 VDC, 50 mA max., residual voltage: 1.2 V max.

## Dimensions

FQ-CR20010F-M/-CR20050F-M  
 FQ-CR25010F-M/-CR25050F-M

(Unit: mm)

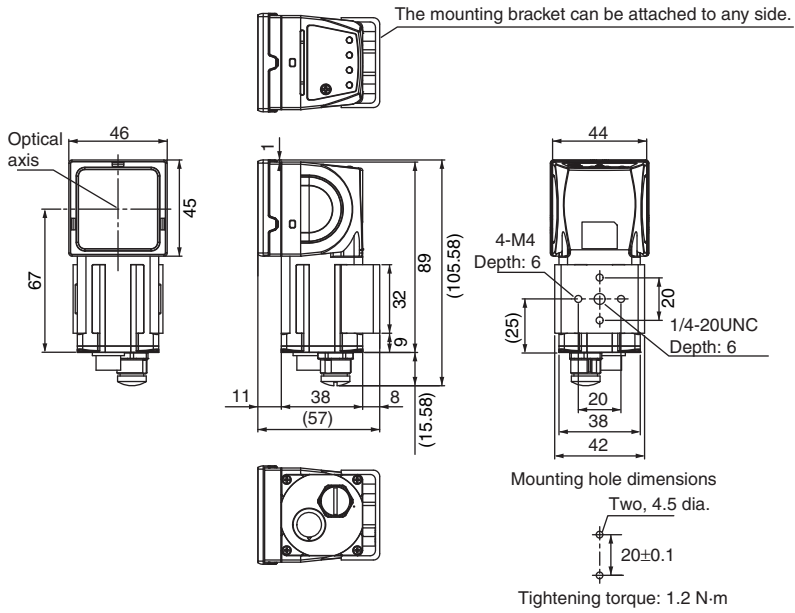

FQ-CR20100F-M/-CR20100N-M  
 FQ-CR25100F-M/-CR25100N-M

(Unit: mm)

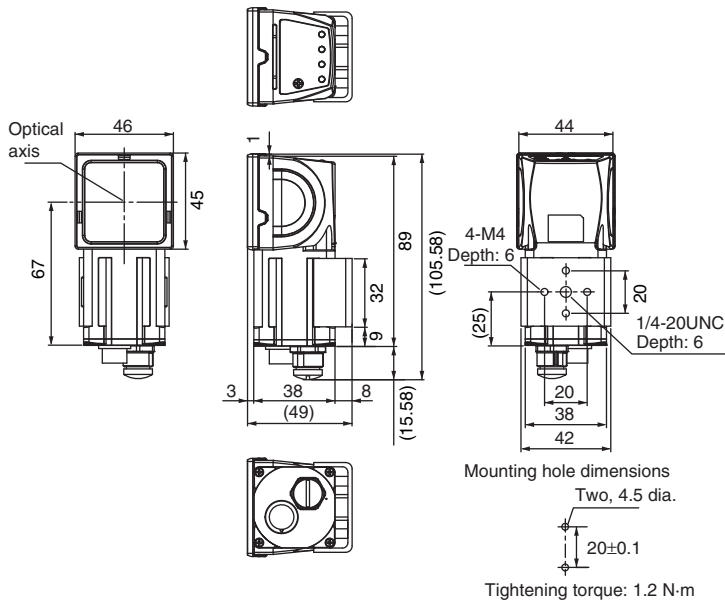

# Touch Finder

## Specifications

Item		Model with DC power supply		Model with AC/DC/battery power supply		
		FQ-D30		FQ-D31		
Number of connectable Sensors		8 max.				
Main functions	Types of measurement displays		Last result display, last NG display, trend monitor, histograms			
	Types of display images		Through, frozen, zoom-in, and zoom-out images			
	Data logging		Measurement results, measured images			
	Menu language		English, German, French, Italian, Spanish, Traditional Chinese, Simplified Chinese, Korean, or Japanese			
Indications	LCD	Display device	3.5-inch TFT color LCD			
		Pixels	320 × 240			
		Display colors	16,777,216			
	Backlight	Life expectancy <sup>1</sup>	50,000 hours at 25°C			
		Brightness adjustment	Provided			
		Screen saver	Provided (The time setting can be changed.)			
	Indicators		Power indicator (color: green): POWER Error indicator (color: red): ERROR SD card access indicator (color: yellow): SD ACCESS	Power indicator (color: green): POWER Error indicator (color: red): ERROR SD card access indicator (color: yellow): SD ACCESS Charge indicator (color: orange): CHARGE		
Operation interface	Touch screen	Method	Resistance film			
		Life expectancy <sup>2</sup>	1,000,000 operations			
External interface	Ethernet		100BASE-TX/10BASE-T			
	SD card		SDHC-compliant, Class 4 or higher recommended			
Ratings	Power supply voltage		DC power connection: 20.4 to 26.4 VDC (including ripple)	DC power connection: 20.4 to 26.4 VDC (including ripple) AC adapter (manufactured by Sino-American Japan Co., Ltd) connection: 100 to 240 VAC, 50/60 Hz Battery connection: FQ-BAT1 Battery (1 cell, 3.7 V)		
	Continuous operation on Battery <sup>3</sup>		---	1.5 h		
	Current consumption		DC power connection: 0.2 A	DC power connection: 0.2 A, Charging battery: 0.4 A		
	Insulation resistance		Between all lead wires and case: 0.5 MΩ (at 250 V)			

Item		Model with DC power supply	Model with AC/DC/battery power supply
		FQ-D30	FQ-D31
Environmental immunity	Ambient temperature range	Operating: 0 to 50°C Storage: -25 to 65°C (with no icing or condensation)	Operating: 0 to 50°C when mounted to DIN Track or panel 0 to 40°C when operated on a Battery Storage: -25 to 65°C (with no icing or condensation)
	Ambient humidity range	Operating and storage: 35% to 85% (with no condensation)	
	Ambient atmosphere	No corrosive gas	
	Vibration resistance (destruction)	10 to 150 Hz, single amplitude: 0.35 mm, X/Y/Z directions 8 min each, 10 times	
	Shock resistance (destruction)	150 m/s <sup>2</sup> 3 times each in 6 direction (up, down, right, left, forward, and backward)	
	Degree of protection	IEC 60529 IP20	
Weight		Approx. 270 g (without Battery and hand strap)	
Dimensions		95 × 85 × 32.5 mm	
Materials		Case: ABS	
Accessories		Touch Pen (FQ-XT), Instruction Manual	

- \*1 This is a guideline for the time required for the brightness to diminish to half the initial brightness at room temperature and humidity. No guarantee is implied. The life of the backlight is greatly affected by the ambient temperature and humidity. It will be shorter at lower or higher temperatures.
- \*2 This value is only a guideline. No guarantee is implied. The value will be affected by operating conditions.
- \*3 This value is only a guideline. No guarantee is implied. The value will be affected by the operating environment and operating conditions.

## • Battery Specifications

Item	FQ-BAT1
Battery type	Secondary lithium ion battery
Nominal capacity	1,800 mAh
Rated voltage	3.7 V
Dimensions	35.3 × 53.1 × 11.4 mm
Ambient temperature range	Operating: 0 to 40°C Storage: -25 to 65°C (with no icing or condensation)
Ambient humidity range	Operating and storage: 35% to 85% (with no condensation)
Charging method	Charged in Touch Finder (FQ-D31).
Charging time <sup>*1</sup>	2 h
Usage time <sup>*1</sup>	1.5 h
Battery backup life <sup>*2</sup>	300 charging cycles
Weight	50 g max.

- \*1 This value is only a guideline. No guarantee is implied. The value will be affected by operating conditions
- \*2 This is a guideline for the time required for the capacity of the Battery to be reduced to 60% of the initial capacity. No guarantee is implied. The value will be affected by the operating environment and operating conditions.



## Dimensions

- FQ-D30/-D31

(Unit: mm)

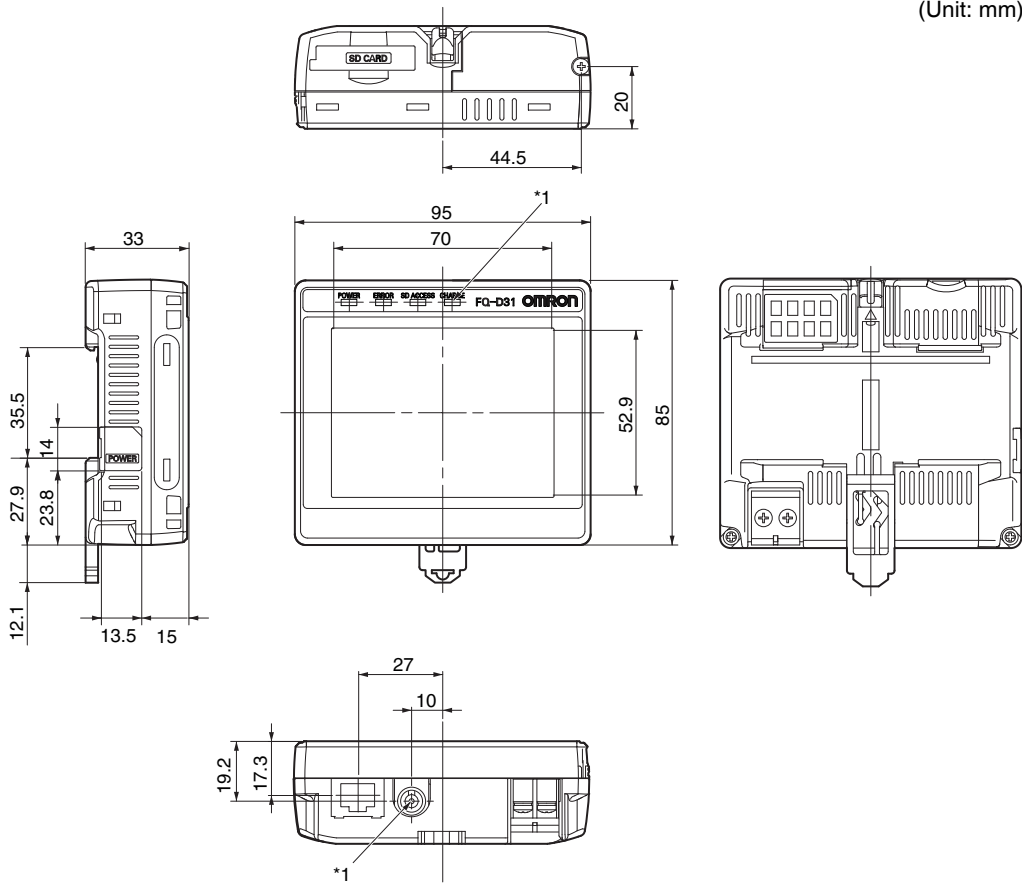

\*1: Provided on the FQ-D31 only.

- Panel Mounting Adapter (FQ-XPM)

(Unit: mm)

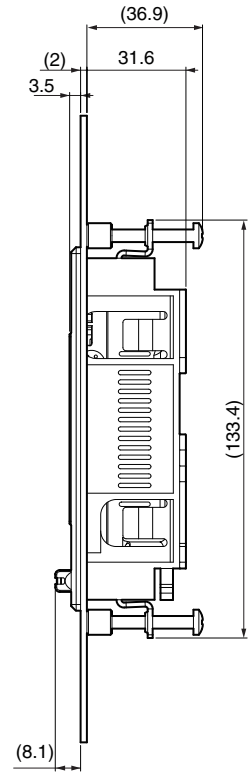
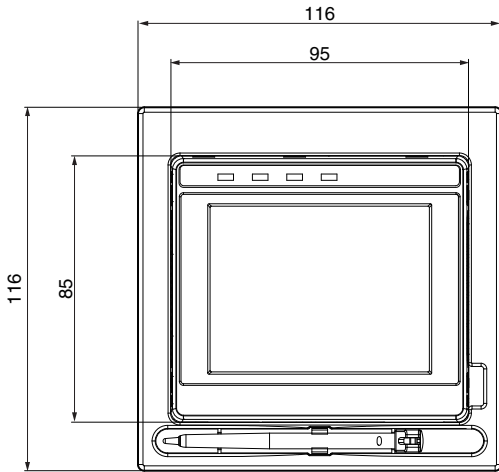

- Panel cutout dimensions

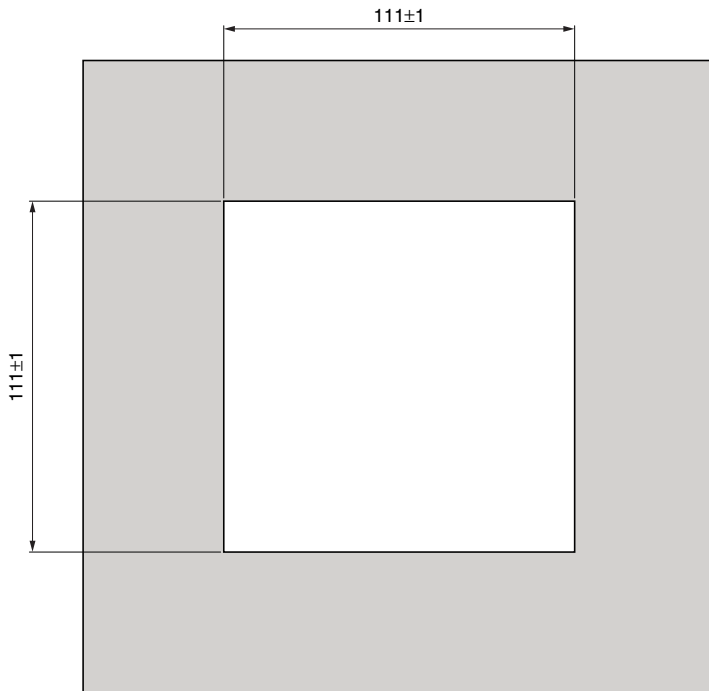

## System Requirements for PC Tool for FQ

The system requirements for the PC Tool are given in the following table.

Item	Requirement
OS	<ul style="list-style-type: none"> <li>Microsoft Windows XP Home Edition/Professional SP2 or higher<sup>*1</sup></li> <li>Microsoft Windows 7 Home Premium or higher<sup>*1</sup></li> </ul>
Hardware	<ul style="list-style-type: none"> <li>CPU: Core 2 Duo 1.06 GHz or the equivalent or higher</li> <li>RAM: 1 GB min.</li> <li>HDD: 500 MB min. available space<sup>*2</sup></li> <li>Monitor: 1,024 x 768 dots min.</li> </ul>

\*1. The Japanese and English versions support only 32-bit OS versions.

\*2. Available space is also required separately for data logging.

## Options

### Specifications

#### • I/O Cables

Item	Model	FQ-WD002	FQ-WD010	FQ-WD020
Cable length		2 m	10 m	20 m
Cable type		Robot cable		
Wire gauge	Power line	AWG24	AWG24 to AWG20	
	Other lines	AWG28		
Cable diameter		6.4	6.4 to 6.7	
Minimum bending radius		41.4 mm		
Weight		100 g	500 g	1500 g

#### • FQ Ethernet Cable

Item	Model	FQ-WN002	FQ-WN010	FQ-WN020
Cable length		2 m	10 m	20 m
Cable type		Robot cable		
Minimum bending radius		40 mm		
Weight		125 g	620 g	1780 g

## • AC Adapter

Item	Model	FQ-AC1	FQ-AC2	FQ-AC3	FQ-AC4	FQ-AC5	FQ-AC6
Plug type		A	A	A	C	BF	O
Certified standards		PSE	UL/CSA	CCC mark	---	---	---
Input voltage		100 to 240 VAC (90 to 264 VAC)					
Input current		0.4 A max., 100 VAC, 50 Hz when connected to maximum load					
Input frequency		47 to 63 Hz					
Output voltage		15 VDC±5%					
Output current		1 A max.					
Ambient temperature range		Operating: 0 to 40°C Storage: -20 to 65°C (with no icing or condensation)					
Ambient humidity range		Operating and storage: 35% to 80% (with no condensation)					
Material		Case: PPE					
Cable length		1.5 m					
Dimensions		78 × 50 × 30 mm (without power cable)					
Weight		Approx. 270 g					
Contents of label on AC Adapter							

## Dimensions

### • I/O Cables

#### FQ-WD002

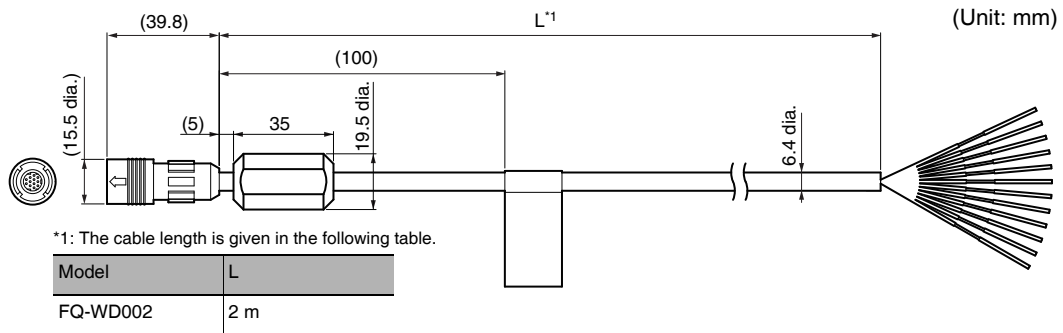

FQ-WD010/WD020

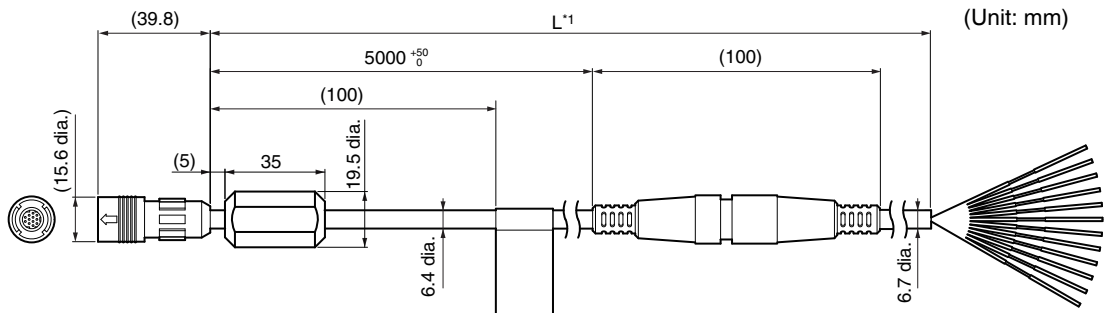

\*1: The cable length is given in the following table.

Model	L
FQ-WD010	10 m
FQ-WD020	20 m

• FQ Ethernet Cable

FQ-WN002/WN010/WN020

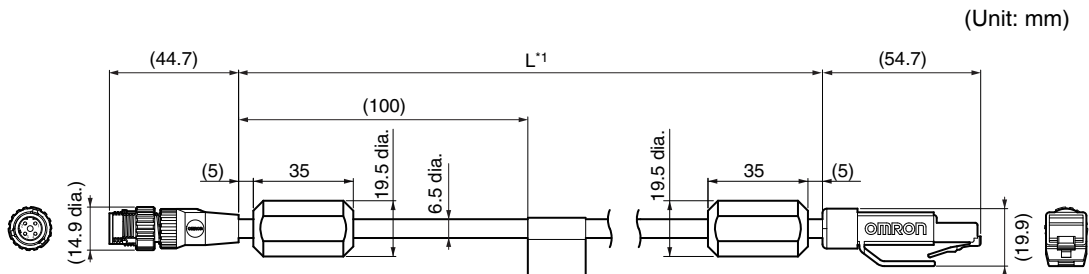

\*1: The cable lengths are given in the following table.

Model	L
FQ-WN002	2 m
FQ-WN010	10 m
FQ-WN020	20 m

• AC Adapter

FQ-AC□

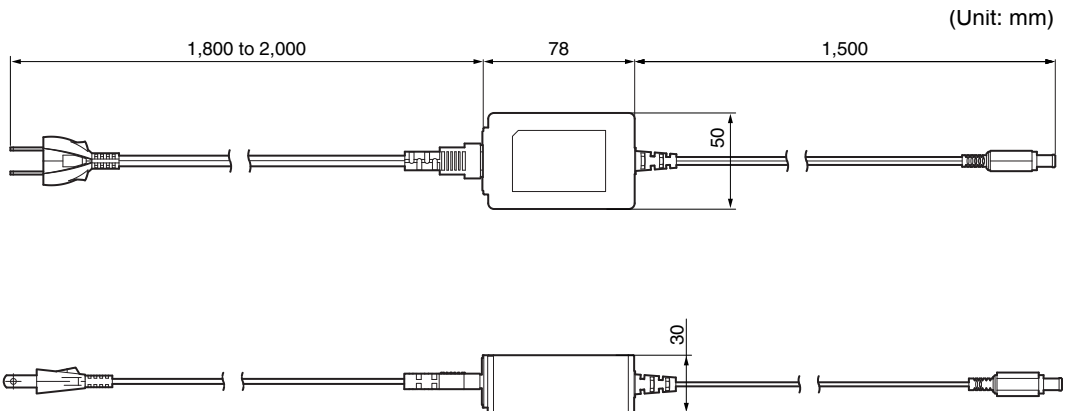

# 10-4 Updating the Software

The most recent version of the software and PC Tool can be downloaded from the following website for OMRON members. Refer to the *Member Registration Sheet* that is enclosed with the Sensor.



[http://www.omron-cxone.com/vision\\_sys](http://www.omron-cxone.com/vision_sys)

After you download the software, use the following procedure to update.

- Updating from the PC Tool

- 1** Store the update file you obtained in the following directory.  
\\...\My Documents\OMRON FQ\SDCard\UPDATE\SENSOR
- 2** To update the software in the Sensor, press  (Setup Mode) - [Sensor settings] - [Update].

- Updating from the Touch Finder

- 1** Place the update file that you obtained directly in the root folder of the SD card.
- 2** Insert an SD card into the Touch Finder.
- 3** To update the software in the Sensor, press  (Setup Mode) - [Sensor settings] - [Update].
- 4** To update the software in the Touch Finder, press  (Setup Mode) - [TF settings] - [Update].

The software will be updated automatically.

### Important

Do not turn OFF the power supply until updating the software has been completed.  
The Sensor or Touch Finder may not start normally if power is turned OFF during the update.

MEMO

# Index

<hr/>	
Numerics	
2D Codes	49
<hr/>	
A	
AC Adapter	178
AC power supply connector	
Touch Finder	20
auto connect	14
Auto length	51
<hr/>	
B	
backing up data	83
backlight	74
Battery	29
specifications	174
battery level	90
brightness	74
Brightness step	93
BUSY output	78
BUSY polarity	106
BUSY: ON	106
READY: ON	106
BUSY signal	96
<hr/>	
C	
camera input	63
camera setup	35
capturing	87
Cell	51
Cell Recog. Rate	168
changing line process	
using scenes	70
Characters	168
Code color	51
Code type	51
configuration	47
connection	
automatic	14
Contrast	168
CSV	78
<hr/>	
D	
data	
backup	83
saving	58, 83
saving to file	83
DC power supply connector	
Touch Finder	20
decimal symbol	78
Decrement count	93
deleting log	80
Dilate	44
display elements	15
display language	89
display patterns	63
<hr/>	
display types	
Graphics	62
Graphics + Details	62
Statistical data	62
displaying image data	88
<hr/>	
E	
ECO mode	74
Erosion	44
Error Correction Level	51
error history	154, 155
deleting	155
viewing	155
ERROR signal	110
errors	
clearing	107
messages	155
Ethernet	31
Ethernet cable	177
connector	19
Ethernet port	
Touch Finder	20
exposure retry	92
external trigger	97
<hr/>	
F	
Fast mode	51
field separator	78
file format	78
files	
logging	76
Filter Type	44
Focus	168
focus	35
adjustment screw	35
formatting SD cards	85
FQ Ethernet Cable	177
frozen images	72
<hr/>	
G	
GUI	
language	89
<hr/>	
H	
hiding menus	74
histograms	65
auto display	65
display range	
class	65
number of data	65
<hr/>	
I	
I/O Cable	26
connector	19
I/O Cables	177
I/O monitor	75
If Scanning Fails	67



image data			
logging	76	takt time	56
image input		Median	44
increasing speed	56	Memory State	90
partial input	56	menus	
images		hiding	74
displaying last NG image	73	mounting	
displaying saved images	73	control panel	23
frozen	72	DIN Track	23
live	72	Mounting Bracket	19
updating	73	mutual interference	
zooming in	72	preventing	43
zooming out	72		
zooming to fit display	72	N	
Increment count	93	NG String output	121
individual judgements	102	normal retry	92
initialize	89	NPN	27
initializing		Num. of char.	168
Sensor and Touch Finder	89		
input mode	160	O	
inputs		one-shot output	105
IN0 to IN5	26	operation	59
TRIG	26	operation indicators	
inspection items		BUSY	19
copying	48	CHARGE	20
deleting	48	ERROR	19, 20
renaming	48	ETN	19
integrated Sensor lighting	89	OR	19
Interval	92	POWER	20
IP address	32	SD ACCESS	20
		Sensor	19
J		Touch Finder	20
judgements		optical charts	21
all results/region	57	OR signal	96
individual	102	output delay	105
overall	101	Output end digit	169
		output mode	105
L		output polarity	106
language	89	NG: ON	106
LCD backlight	74	OK: ON	106
level output	105	Output starting digit	169
lighting	89	output time	105
control	89	outputs	
live images	72	BUSY	26
loading data from files	83	ERROR	26
logging	76, 77	OR	26
deleting log	80	OUT0	26
recent results	79	OUT1	26
selecting data to be logged	76	OUT2	26
settings	76	Outputting the Scan Result	121
starting and stopping	77	overall judgements	101
M		P	
MAC address	163, 164	Panel Mounting Adapter	23, 176
Max count	92	Partial output	121
measurement data		password	86
logging	76	PC Tool	18, 177
measurement time	56	PNP	27
measurements		Polarizing Filter	
continuous	99, 107	using	40

power supply switch		36
Touch Finder	20	
Preventing Mutual Interference of Multiple Sensors	43	
<hr/>		
Q		
QR Code Model	51	
<hr/>		
R		
record separator	78	
remaining Sensor	90	
re-measuring	54	
restart	89	
restarting		
Sensor and Touch Finder	89	
Retry Function	91	
Reverse	51	
Run Mode	15, 60	
<hr/>		
S		
saved images		
displaying	73	
saving data	58, 83	
saving data to files	83	
saving image data	88	
scene data		
saving	83	
scene group data		
saving	83	
scene retry	93	
scenes		
changing	70	
changing names	71	
copying	71	
deleting	71	
switching	107	
SD card		
available space	85	
formatting	85	
information	85	
operations	84	
slot	20	
Sensor data		
saving all Sensor data	83	
Sensor information	90	
Sensor monitor	62	
Sensor system data		
saving	83	
Sensors		
renaming	90	
specifications	170	
switching	34	
Setting 2D Code Inspection Conditions	49	
Setting How the Image is Processed After Scanning	44	
Setting the Inspection Timeout Time	90	
Setting the Retry Function	91	
Setup Mode	15	
returning to Setup Mode	61	
Shape	51	
<hr/>		
Shutter speed		36
Size		168
Smooth		44
startup display		63
startup mode		71
startup scene		71
startup settings		71
statistical data		
logging		80
straps		24
String output		121
subnet mask		32
Switch Sensor		34
Switching Hub		18
system configuration		18
<hr/>		
T		
test measurements		
continuous test		54
performing		54
Test Tab Page		54
time		
Touch Finder		89
Touch Finder		173
information		90
model with AC/DC/battery power supply		173
model with DC power supply		173
time settings		89
Touch Finder data		
saving		83
trend monitor		64
Auto display		64
Display range		64
Number of data		64
TRIG signal		96
trigger delay		41, 43
trigger retry		94
<hr/>		
U		
updating		
software version		180
<hr/>		
V		
versions		90
<hr/>		
W		
wiring		26
Sensor		26
Touch Finder		28
<hr/>		
Z		
zooming		72



# Revision History

A manual revision code appears as a suffix to the catalog number at the bottom of the front and back covers of this manual.

Cat. No. Z316-E1-02

↑  
Revision code

Revision code	Date	Revised contents
01	July 2011	Original production
02	August 2015	Additions corresponding to change of EN standard.



**OMRON Corporation Industrial Automation Company**  
Kyoto, JAPAN

**Contact: [www.ia.omron.com](http://www.ia.omron.com)**

**Regional Headquarters**

**OMRON EUROPE B.V.**

**Sensor Business Unit**

Carl-Benz-Str. 4, D-71154 Nufringen, Germany  
Tel: (49) 7032-811-0/Fax: (49) 7032-811-199

**OMRON ASIA PACIFIC PTE. LTD.**

No. 438A Alexandra Road # 05-05/08 (Lobby 2),  
Alexandra Technopark,  
Singapore 119967  
Tel: (65) 6835-3011/Fax: (65) 6835-2711

**OMRON ELECTRONICS LLC**

2895 Greenspoint Parkway, Suite 200  
Hoffman Estates, IL 60169 U.S.A.  
Tel: (1) 847-843-7900/Fax: (1) 847-843-7787

**OMRON (CHINA) CO., LTD.**

Room 2211, Bank of China Tower,  
200 Yin Cheng Zhong Road,  
PuDong New Area, Shanghai, 200120, China  
Tel: (86) 21-5037-2222/Fax: (86) 21-5037-2200

**Authorized Distributor:**

© OMRON Corporation 2011 All Rights Reserved.  
In the interest of product improvement,  
specifications are subject to change without notice.

**Cat. No. Z316-E1-02**

0815