

Vision Sensor

FJ Series (Camera & Software Vision Package)

PC Vision System

Camera Setup Guide

FJ-S□□G/FJ-SC□□G

FJ-S□□G2/FJ-SC□□G2

FJ-S□□G-S/FJ-SC□□G-S

FJ-S□□G2-S/FJ-SC□□G2-S

NOTE

- All rights reserved.
- No part of this publication may be reproduced, stored in a retrieval system, or transmitted, in any form, or by any means, mechanical, electronic, photocopying, recording, or otherwise, without the prior written permission of OMRON.
- No patent liability is assumed with respect to the use of the information contained herein. Moreover, because OMRON is constantly striving to improve its high-quality products, the information contained in this manual is subject to change without notice. Every precaution has been taken in the preparation of this manual. Nevertheless, OMRON assumes no responsibility for errors or omissions.

Neither is any liability assumed for damages resulting from the use of the information contained in this publication.

Trademarks

- This software is based in part on the work of the Independent JPEG Group.
- Microsoft, Windows, Windows Vista, Excel, and Visual Basic are either registered trademarks or trademarks of Microsoft Corporation in the United States and other countries.
- Intel, Core and Pentium are trademarks of Intel Corporation in the U.S. and/or other countries.
- EtherCAT® is registered trademark and patented technology, licensed by Beckhoff Automation GmbH, Germany.
- ODVA, CIP, CompoNet, DeviceNet, and EtherNet/IP are trademarks of ODVA.

Other company names and product names in this document are the trademarks or registered trademarks of their respective companies.

Copyrights

Microsoft product screen shots reprinted with permission from Microsoft.

Introduction

Thank you for purchasing the FJ Series.

This manual contains information that is necessary to use the FJ Series.

Please read this manual and make sure you understand the functionality and performance of the FJ Series before you attempt to use it in a control system.

Keep this manual in a safe place where it will be available for reference during operation.

Intended Audience

This manual is intended for the following personnel, who must also have knowledge of electrical systems (an electrical engineer or the equivalent).

- Personnel in charge of introducing FA systems.
- Personnel in charge of designing FA systems.
- Personnel in charge of installing and maintaining FA systems.
- Personnel in charge of managing FA systems and facilities.

Applicable Products

This manual covers the following products.

- FJ-SG/FJ-SCG/FJ-S2MG/FJ-SC2MG/FJ-S5MG/FJ-SC5MG
- FJ-SG2/FJ-SCG2/FJ-S2MG2/FJ-SC2MG2/FJ-S5MG2/FJ-SC5MG2
- FJ-SG-S/FJ-SCG-S/FJ-S2MG-S/FJ-SC2MG-S/FJ-S5MG-S/FJ-SC5MG-S
- FJ-SG2-S/FJ-SCG2-S/FJ-S2MG2-S/FJ-SC2MG2-S/FJ-S5MG2-S/FJ-SC5MG2-S

Part of the specifications and restrictions are given in other manuals. Refer to the Instruction Manuals and the Data Sheet.

Manual Structure

Page Structure

The following page structure is used in this manual.

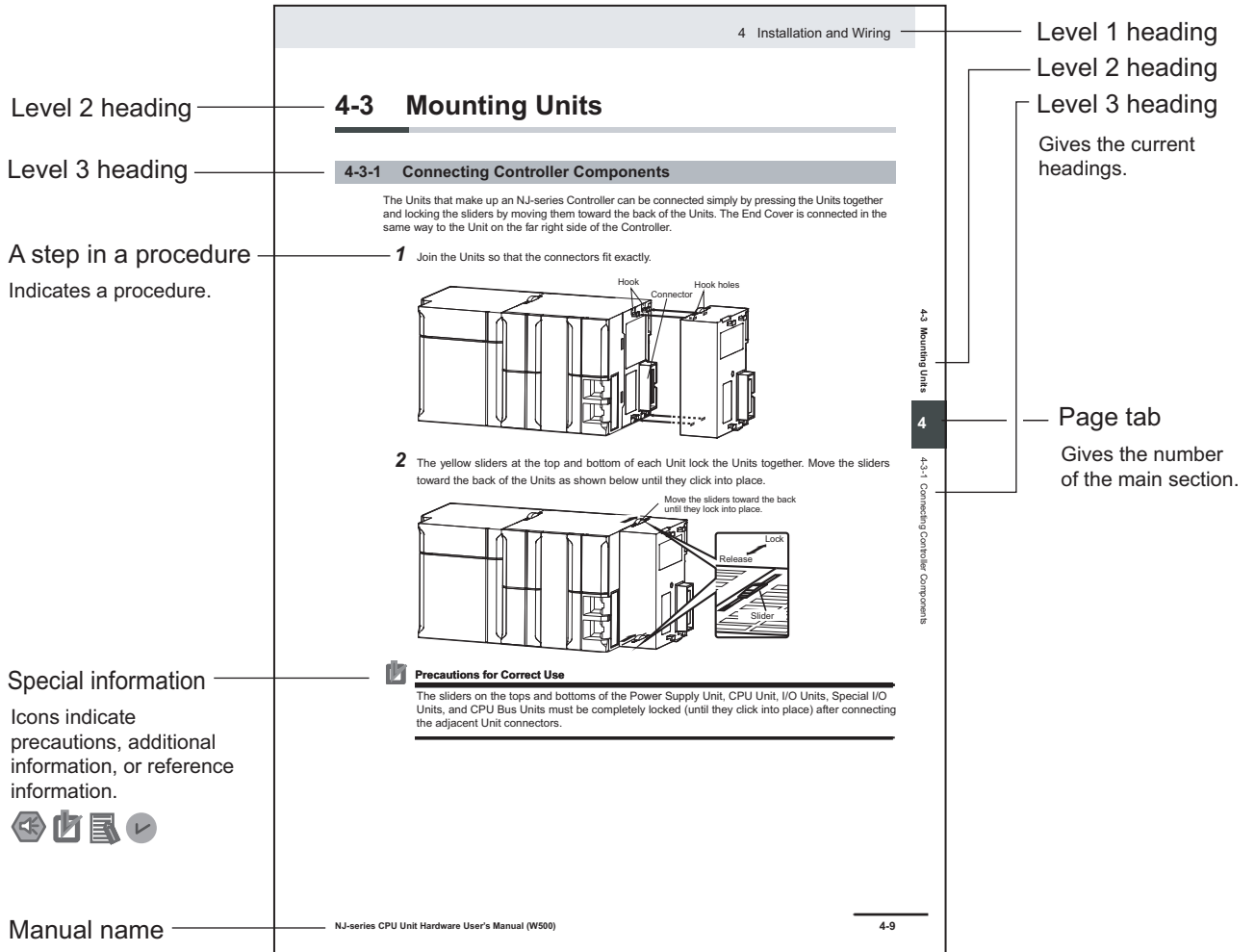

Note This illustration is provided only as a sample. It may not literally appear in this manual.

Special Information

Special information in this manual is classified as follows:



Precautions for Safe Use

Precautions on what to do and what not to do to ensure safe usage of the product.



Precautions for Correct Use

Precautions on what to do and what not to do to ensure proper operation and performance.



Additional Information

Additional information to read as required.

This information is provided to increase understanding or make operation easier.

Sections in This Manual

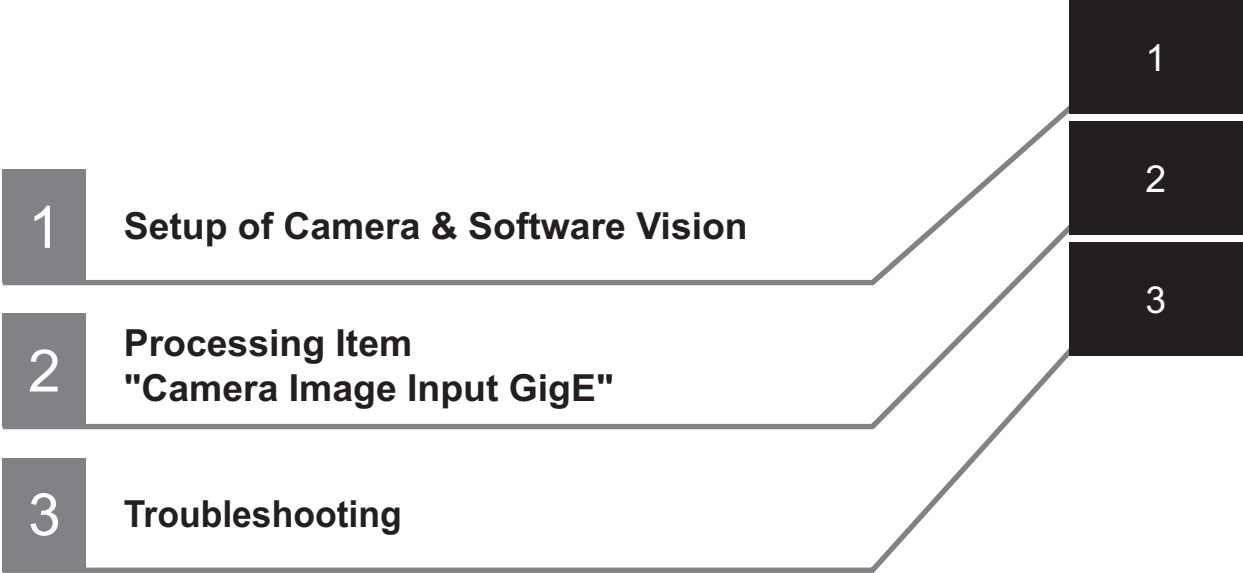

CONTENTS

Introduction	1
Intended Audience	1
Applicable Products	1
Manual Structure.....	2
Page Structure	2
Special Information	3
Sections in This Manual	5
Safety Precautions.....	8
Symbols and the Meanings for Safety Precautions Described in This Manual	8
Meanings of Alert Symbols	8
Warning.....	8
Precautions for Safe Use	10
Power Supply and Wiring	10
Mounting the Camera	10
Grounding	10
Others	11
Precautions for Correct Use	12
Installation Site	12
Connecting Cable	12
Optical axis of the Camera	12
Maintenance	13
Image sensor	13
Others	13
Revision History.....	14

Section 1 Setup of Camera & Software Vision

1-1 Overview	1-2
1-2 Setup of Camera & Software Vision (FJ-S□□□□ Series)	1-3
1-2-1 Prepare hardware	1-3
1-2-2 Install Gigabit ethernet adapter	1-5
1-2-3 Install GigE camera device driver	1-5
1-2-4 Configure Gigabit Ethernet adapter	1-7
1-2-5 Setup of camera connection	1-10
1-2-6 Setup of Software.....	1-11
1-2-7 Settings when connecting multiple GigE Cameras (over 9 units)	1-16
1-3 Setup of Camera & Software Vision (FJ-S□□□□2 Series)	1-18
1-3-1 Prepare hardware	1-18
1-3-2 Install Gigabit ethernet adapter	1-20
1-3-3 Install GigE camera device driver	1-20
1-3-4 Configure Gigabit Ethernet adapter	1-21
1-3-5 Changing the PC Power Settings.....	1-23
1-3-6 Setup of camera connection	1-23
1-3-7 Setup of Software.....	1-26
1-3-8 Settings when connecting multiple GigE Cameras (over 9 units)	1-31

Section 2 Processing Item "Camera Image Input GigE"

2-1	Overview	2-2
2-2	Settings	2-3
2-3	Detailed result display	2-5
2-4	Camera Image Input GigE Timing Chart	2-6

Section 3 Troubleshooting

3-1	Troubleshooting	3-2
-----	-----------------------	-----

Apply the latest security updates on your computer's OS to avoid security risks caused by a vulnerability in the OS.



Always use the highest version of this software to add new features, increase operability, and enhance security.



Manage usernames and passwords for this software carefully to protect them from unauthorized uses.



Set up a firewall (E.g., disabling unused communication ports, limiting communication hosts, etc.) on a network for a control system and devices to separate them from other IT networks. Make sure to connect to the control system inside the firewall.



Caution

Danger of burns. Do not touch the case while the sensor is running or just after power is turned OFF, since it remains extremely hot.



Revision History

A manual revision code appears as a suffix to the catalog number on the front and back covers of the manual.

Cat. No.	Z428-E1-03
-----------------	-------------------

↑
Revision code

Rev. Code	Rev. Date	Revision Contents
01	Jan. 2020	Original product
02	Sep. 2022	Revisions for adding safety precautions regarding security
03	Jun. 2025	Added Windows 11 to the supported OS. Corrected mistakes

1

Setup of Camera & Software Vision

1-1	Overview	1-2
1-2	Setup of Camera & Software Vision (FJ-S□□□□ Series)	1-3
1-2-1	Prepare hardware	1-3
1-2-2	Install Gigabit ethernet adapter	1-5
1-2-3	Install GigE camera device driver	1-5
1-2-4	Configure Gigabit Ethernet adapter	1-7
1-2-5	Setup of camera connection	1-10
1-2-6	Setup of Software	1-11
1-2-7	Settings when connecting multiple GigE Cameras (over 9 units)	1-16
1-3	Setup of Camera & Software Vision (FJ-S□□□□2 Series)	1-18
1-3-1	Prepare hardware	1-18
1-3-2	Install Gigabit ethernet adapter	1-20
1-3-3	Install GigE camera device driver	1-20
1-3-4	Configure Gigabit Ethernet adapter	1-21
1-3-5	Changing the PC Power Settings	1-23
1-3-6	Setup of camera connection	1-23
1-3-7	Setup of Software	1-26
1-3-8	Settings when connecting multiple GigE Cameras (over 9 units)	1-31

1-1 Overview

System composed by controller and GigE camera provided from OMRON and PC provided from Customer.



Precautions for Correct Use

Our GigE camera can only work with FJ series.
And, system other than Camera & Software Vision System can not work with our GigE camera.
Camera & Software Vision can not work with GigE camera made by another company.



Precautions for Correct Use

When using the GigE cameras, the following operation modes of the image sensor software cannot be used.

- Double Speed Multi input mode
- Non-stop adjustent mode



Precautions for Correct Use

Development environment Application Producer (FH-AP1) supports Windows 10, but GigE camera does not support Windows 10.

Please use Camera & Software Vision software created with FH-AP1 in an environment supporting GigE camera.

Model	FJ-S□□□□ Series	FJ-S□□□□2 Series
	FJ-SG/FJ-SCG/ FJ-S2MG/FJ-SC2MG/ FJ-S5MG/FJ-SC5MG FJ-SG-S/FJ-SCG-S/ FJ-S2MG-S/FJ-SC2MG-S/ FJ-S5MG-S/FJ-SC5MG-S	FJ-SG2/FJ-SCG2/ FJ-S2MG2/FJ-SC2MG2/ FJ-S5MG2/FJ-SC5MG2 FJ-SG2-S/FJ-SCG2-S/ FJ-S2MG2-S/FJ-SC2MG2-S/ FJ-S5MG2-S/FJ-SC5MG2-S
OS	Windows 7 (32bit/64bit) Windows 8 (32bit/64bit) Windows 8.1 (32bit/64bit)	Windows 7 (32bit/64bit) Windows 10 (32bit/64bit) Windows 11 (64bit)

1-2 Setup of Camera & Software Vision (FJ-S□□□□ Series)

1-2-1 Prepare hardware

System configuration:

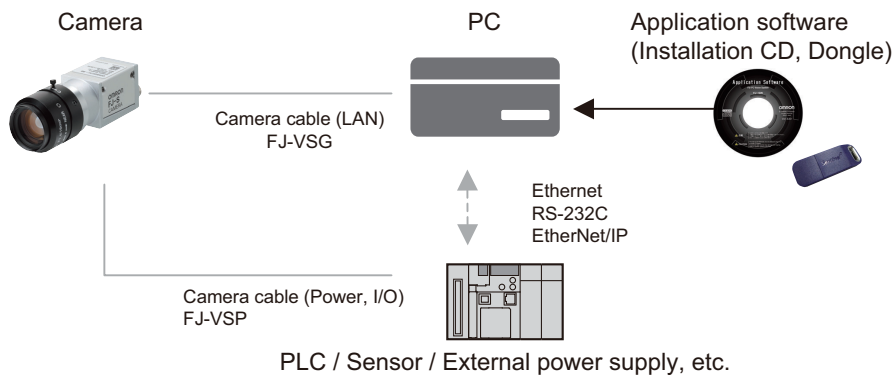

First prepare hardware components to construct the system.

- Required: PC
- Required: GigE Camera (in the quantity required)
- Required: Application software (Installation CD and Dongle)
- Required: Gigabit Ethernet adapter (PoE type is recommended)
- Required: Camera cable (LAN)
- As needed: Camera cable (Power, I/O)
- As needed: External power supply unit for cameras (In case PoE is not used)
- As needed: PoE Injector
- As needed: Switching HUB (In case multiple cameras are used)
- As needed: LAN cable

Shown below are the combinations of quantity of cameras, and type of power supply.

Index	Quantity of cameras	Power supply
1	1 unit	PoE Gigabit Ethernet adapter
2	1 unit	External power source
3	1 unit	PoE Injector
4	Multiple units	External Power supply unit (for each cameras)
5	Multiple units	PoE Switching HUB
6	Multiple units	PoE Injector

1 Setup of Camera & Software Vision

Pattern No.1

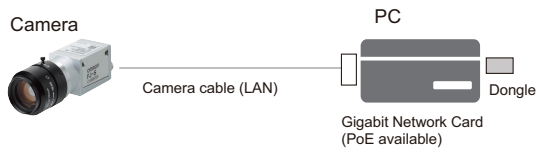

Pattern No.2

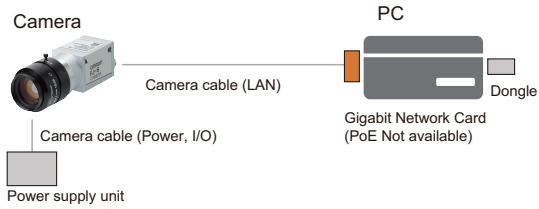

Pattern No.3

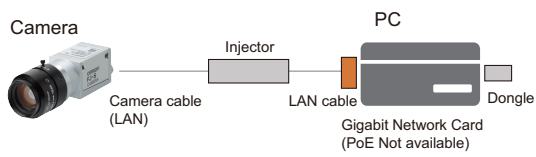

Pattern No.4

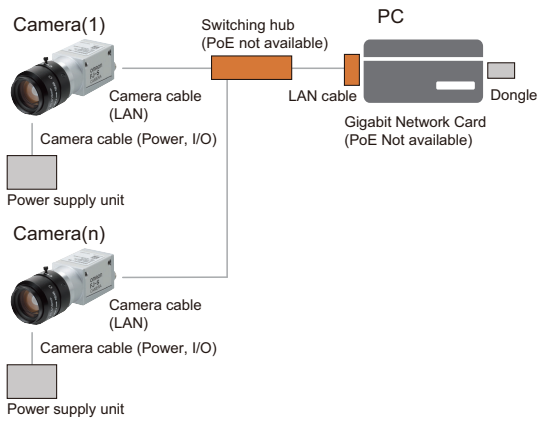

Pattern No.5

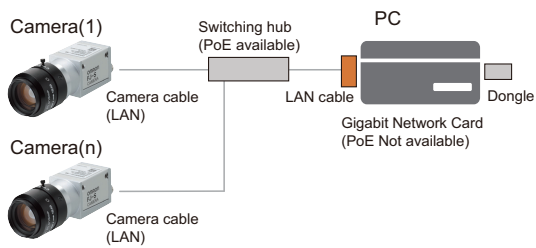

Pattern No.6

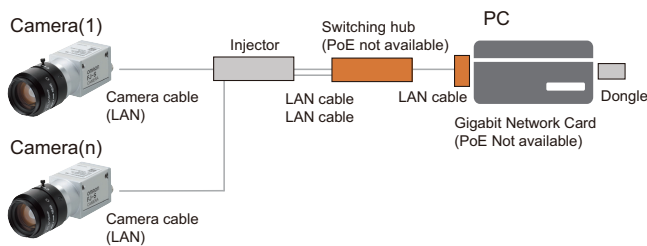



Precautions for Correct Use

The LAN network you use for communication with cameras should be used only for communication with the cameras.
Do not use it for communication with other devices.



Additional Information

PoE(Power over Ethernet) is a technology for delivering electrical power via standard Ethernet cabling.

When PoE camera is connected to PoE power sourcing equipments, such as PoE switching hub or PoE injector, camera can be powered via network cable.

For FJ Series, the following cameras are PoE cameras.

- FJ-SG/FJ-SCG/FJ-S2MG/FJ-SC2MG
- FJ-SG2/FJ-SCG2/FJ-S2MG2/FJ-SC2MG2/FJ-S5MG2/FJ-SC5MG2

1-2-2 Install Gigabit ethernet adapter

Following manufacturer's instructions, install Gigabit ethernet adapter hardware and device driver software.

1-2-3 Install GigE camera device driver

Following the steps shown below, install device drivers of camera and dongle from installation CD. Installation of device driver must be done by Administrator authority.

Displayed messages can have slight difference, depends on the version, or operating system on PC.

- 1 Insert installation CD into PC. Then setup program starts automatically.

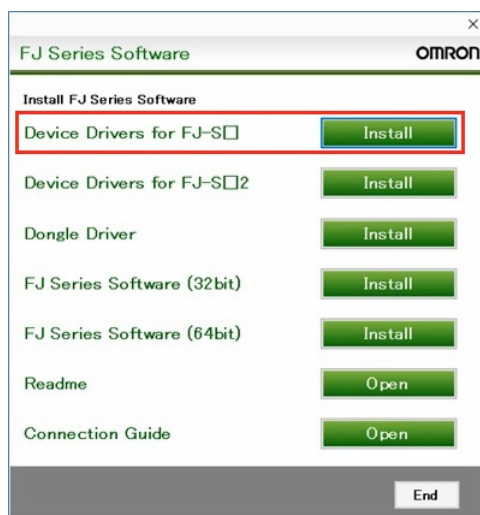

- 2 Click **Install** button for device driver. Then setup for camera device driver starts. Please install it with default option, if there is no special reason to change.

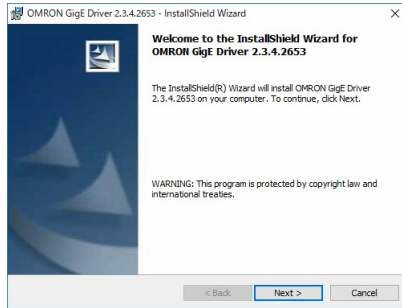

- 3** After installation of camera device driver, then setup for dongle device driver starts. Please install it with default option, if there is no special reason to change.

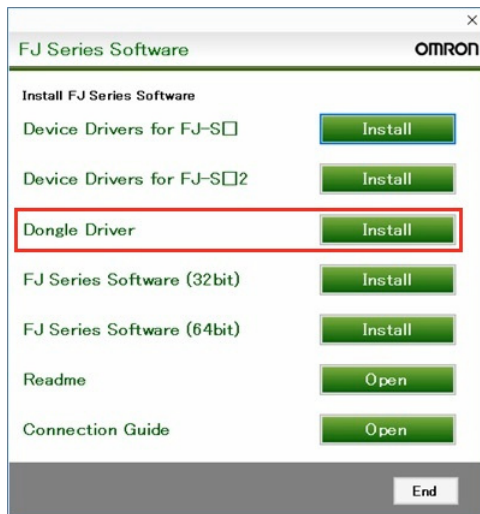

- 4** After installation of dongle device driver, return to setup program (step 1.). Click **End** button and restart PC.



Precautions for Correct Use

- Both FJ-S□□□□ and FJ-S□□□□2 cameras cannot be used at the same time from the PC.
- Please install either **Device Driver for FJ-S□** or **Device Driver for FJ-S□2**.

1-2-4 Configure Gigabit Ethernet adapter

To be able to connect the camera to the Ethernet card, you must configure Gigabit Ethernet adapter. The description in this section assume connecting one camera per one ethernet adapter. In case you need to connect multiple cameras, please refer to *Connecting multiple cameras* on page 1-11 described later.

Network configuration (Protocol)

Configure network following the steps below.
for Windows 7, 8

- 1 Open **Properties** from Network Connections -> Local Area Connection.

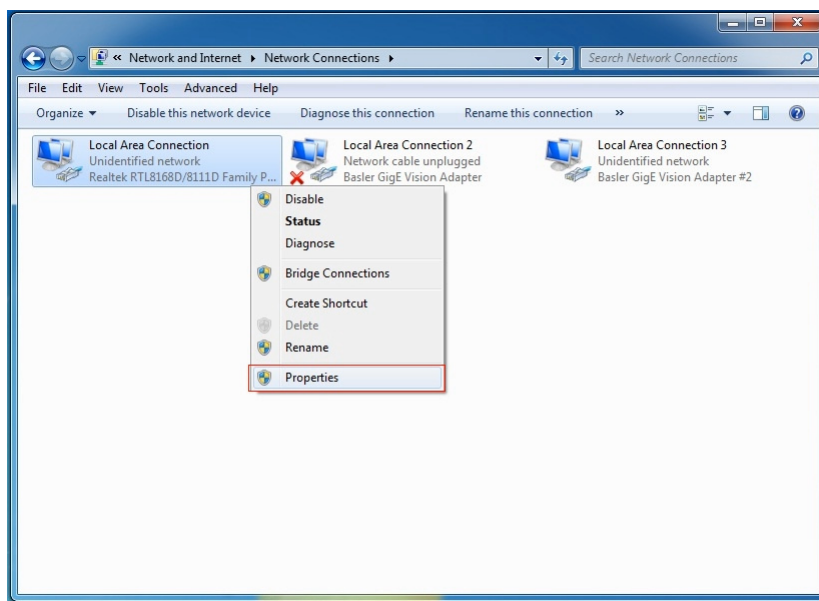

- 2 Uncheck all the items except *Pylon GigE Vision Streaming Filter* and *Internet Protocol Version 4(TCP/IPv4)*.

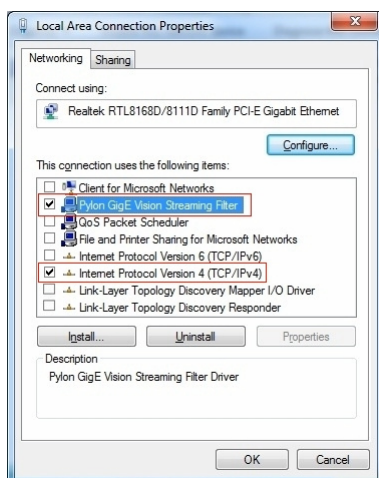

- 3 Select *Internet Protocol Version 4(TCP/IPv4)*, and click **Properties**.

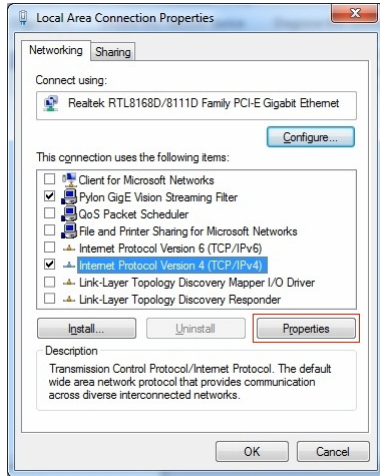

- 4** Select *Use the following IP address*, set the following addresses. After that, click **OK** button and close all the dialog.

Item	Value
IP address	192.168.1.1
Subnet mask	255.255.255.0

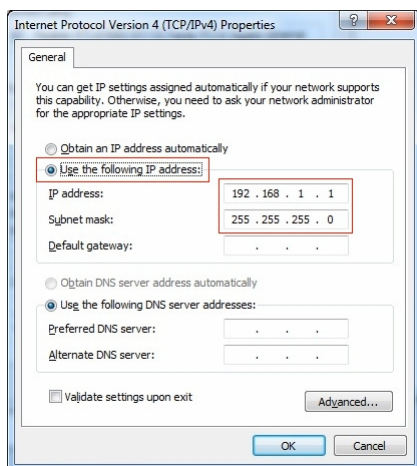

Network configuration (Detail)

Configure detailed network parameters following the steps below.

For Windows 7, 8

- 1** Open **Configure** from Network Connections -> Local Area Connection.

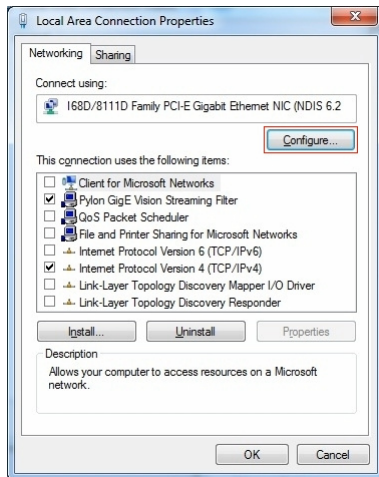

2 Select **Advanced** tab, and set the following parameters.

Your network adapter may show the parameters in different name, or some of the parameters are not supported.

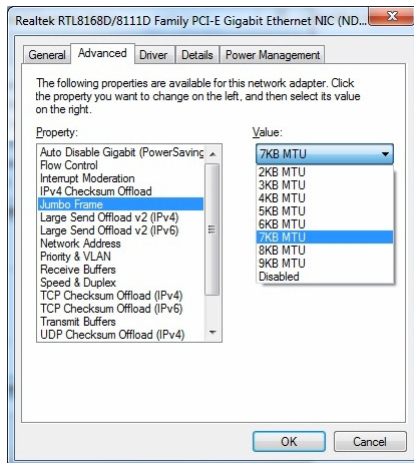

Item	Value	Description
Jumbo Frame	Maximum value supported by network adapter	Size of data for one cycle of communication. Setting bigger value makes the data transmission more efficient.
Receive Descriptor	Maximum value supported by network adapter	The parameter related to the capacity of a receive buffer. Setting bigger value makes the data receive more efficient.
Interrupt Moderation rate	Minimum value	The quantity of interrupt to CPU for each received packet. Lower value so the driver is more responsive to incoming and outgoing packets.
Speed and Duplex Mode	Automatic	Speed and communication mode



Additional Information

If you cannot find some of the parameters shown above, it is not necessary to set it.

Firewall settings

Disable the security settings for the Ethernet port to which the camera is connected.

1-2-5 Setup of camera connection

Setup the camera connection following the steps below.

- 1** Connect the camera cable (Power, I/O) to DC 12V power source.



Additional Information

For wiring, refer to the instruction manuals.

- 2** Connect the camera cable (LAN) and camera cable (Power, I/O) to FJ camera, and turn on the power.

- 3** Launch **IP Configuration Tool** by double-clicking the shortcut.



- 4** Make sure the FJ camera is listed on *Model Name*. In case no camera is listed, click **Refresh** button, and check that camera appears on the list. (In some cases, it takes approximately 30 seconds for detecting camera connection. If no camera is listed, click **Refresh** button after waiting for a while.)

- 5** Check *Persistent IP* on **IP Configuration Protocol**, and set the value below to **Persistent IP Address**. Click **Save** button and close the program.

Item	Value
IP Address	192.168.1.2
Subnet Mask	255.255.255.0
Default Gateway	0.0.0.0

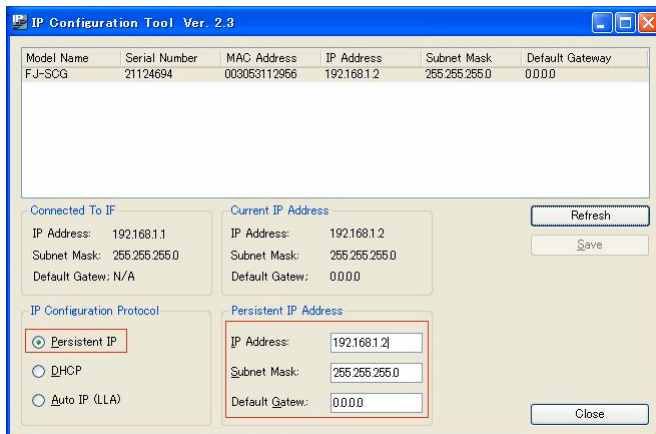



Additional Information

If a DHCP server is running on the network, it is possible to set its IP address by DHCP. Check **DHCP** on **IP Configuration Protocol**. However, this is limited to when you only wish to connect one camera.

Connecting multiple cameras

There are following ways for connecting multiple cameras.

- Install multiple network adapters.
- Use network adapter with multiple ports.
- Use switching HUB.

Refer to *1-2-5 Setup of camera connection* on page 1-10 for connection settings.



Additional Information

For both cases, set persistent IP address for each cameras which is not duplicated with other devices.

In the case of using the PC with multiple Ethernet ports, each adapter must have IP address which network address is different from other Ethernet ports.

The network address can be calculated from the logical product (AND) between the IP address and network mask.

1-2-6 Setup of Software

Installation

Setup standard FJ software from installation CD, following the steps below.

- 1** Insert installation CD into PC. Then setup program starts automatically.

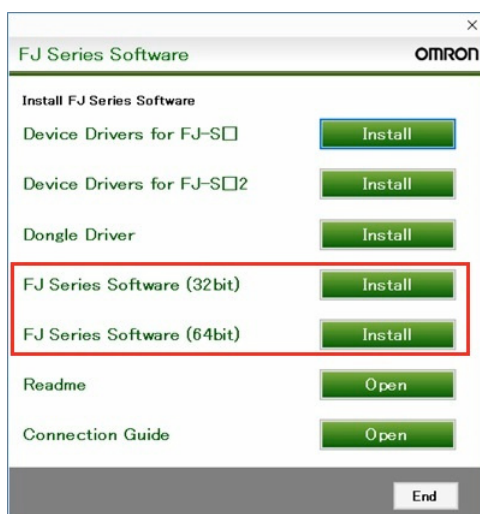

- 2** Click **Install** button for FJ Series Software. Then setup for camera device driver starts.



Precautions for Correct Use

- Install and use either 32-bit or 64-bit software according to your environment.

Assign a camera number

Following the steps below, assign a camera number for each camera connected.

- 1 Launch the tool from Start menu - **OMRON - Camera Configuration Tool**.
- 2 Select camera from the list to each camera number (CameraNo).
When select CameraID cell, the connected camera list will be displayed.

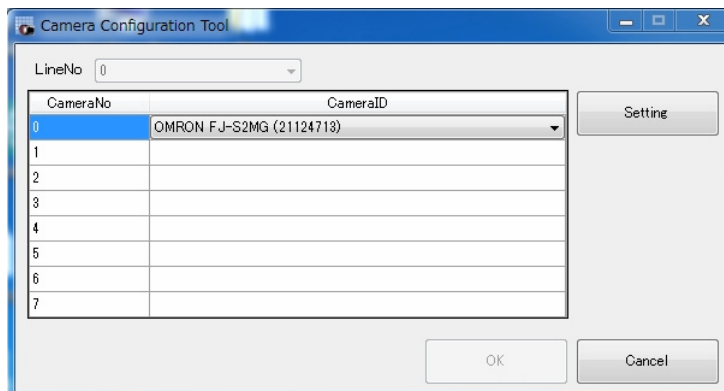

- 3 Click **OK**.

Detailed setting for cameras

- 1 Click **Setting** button on **Camera Configuration Tool**, then detailed setting dialog for selected camera will appear.
- 2 The parameters can be changed on the detailed setting dialog.
These are the parameters.

Category	Item	Value	Description
External trigger	Line invert	<ul style="list-style-type: none"> • Enable • Disable 	Invert trigger polarity. <ul style="list-style-type: none"> • Enable: Invert (Photo coupler OFF) • Disable: Not invert (Photo coupler ON)
	Trigger delay time(μs)	0 to 1000000	Set the time from recognizing trigger to releasing the shutter of a camera.
	Trigger sensing pulse-width time(μs)	0 to 20000	Set the pulse-width time for recognizing trigger of a camera.

Category	Item	Value	Description
Output port setting	Signal select	<ul style="list-style-type: none"> • Trigger ready • Strobe trigger 	<ul style="list-style-type: none"> • Trigger ready: The signal which is ON while trigger signal can be input. • Strobe trigger: The signal for strobe trigger.
	Line invert	<ul style="list-style-type: none"> • Enable • Disable 	Invert signal select polarity. <ul style="list-style-type: none"> • Enable: Invert (Photo coupler OFF) • Disable: Not invert (Photo coupler ON)
Strobe trigger setting	Signal delay time(μs)	0 to 4095	This setting is valid when Signal select is <i>Strobe trigger</i> . Set the delay time.
	Signal pulse-width time(μs)	0 to 4095	This setting is valid when Signal select is <i>Strobe trigger</i> . Set the pulse-width time.
I/O monitor	TRG port	<ul style="list-style-type: none"> • ON • OFF 	Indicate the input state of TRG port.
	Output port	<ul style="list-style-type: none"> • ON • OFF 	Indicate the output state of Output port.
Ethernet	Packet size	220 to 16404	Set the packet size for transmitting from a camera.
	Inter-Packet delay	FJ-SCG: 0 to 42864 FJ-SG: 0 to 86251 FJ-SC2MG: 0 to 16430 FJ-S2MG: 0 to 35579 FJ-SC5MG: 0 to 439 FJ-S5MG: 0 to 3736 FJ-SC5MGR: 0 to 12487 FJ-S5MGR: 0 to 12487 (Unit: Tick, FJ-S□□□ Camera: 1 [Tick] = 8 [ns])	Set the delay time of packets between. Set for preventing packet-loss because of connecting multiple cameras in one LAN. Set with Packet transmission delay.
	Packet transmission delay	0 to 5000000 (Unit: Tick, FJ-S□□□ Camera: 1 [Tick] = 8 [ns])	Set the delay time to transmit packets. Set for preventing packet-loss because of connecting multiple cameras in one LAN. Set with Inter-Packet delay.

3 Click **OK** button and the changes are enabled.

● Initializing camera settings

1 Clicking **Restore the default setting** on **Camera Configuration Tool** restores default setting.

Start the application software

- 1 Connect the dongle of application software to the PC.
The LED of the connected dongle lights up.
- 2 Launch the application software from the Start Menu - **OMRON - FJ-SW**.



Precautions for Correct Use

- Install and use either 32-bit or 64-bit software according to your environment.

Configuration of Processing Item "Camera Image Input GigE"

Refer to *Section 2 Processing Item "Camera Image Input GigE"* on page 2-1.

Making measurement flow

You must allocate "Camera Image Input GigE" unit for each GigE cameras connected to the system. In each unit, you need to select camera to handle. (Example 1)

One camera can be handled by multiple Camera Image Input GigE units. In this case, each unit receives camera image with modified camera parameters following the measurement flow. (Example 2)

- Example 1: Add four Camera Image Input GigE units to use four cameras.

FZ-Flow	
	0.Camera Image Input GigE For Camera0
	1.Search
	2.Camera Image Input GigE For Camera1
	3.Flexible Search
	4.Camera Image Input GigE For Camera2
	5.ECM Search
	6.Camera Image Input GigE For Camera3
	7.Ec Circle Search

- Example 2: Input multiple images with different camera parameters from one camera, by adding multiple Camera Image Input GigE units.

FZ-Flow	
	0.Camera Image Input GigE Camera0 : Shutter Speed = 10000 μs
	1.Search
	2.Camera Image Input GigE Camera0 : Shutter Speed = 5000 μs
	3.Flexible Search

1-2-7 Settings when connecting multiple GigE Cameras (over 9 units)

In its initial state, the maximum number of cameras is 8. Therefore the following change is required to connect 9 or more cameras. Maximum of 16 GigE cameras can be connected for use.



Precautions for Correct Use

The maximum number of cameras that can be connected will depend on factors such as the specifications of the PC andit System environment settings.

When you wish to connect and use multiple cameras, first check to make sure of the maximum number the system will support.

Setting for multiple camera units

● Editing FZ-Option.ini

Editing "FZ-Option.ini" for setting.

Refer to *Others* on page 1-15 about FZ-Option.ini.

Open "FZ-Option.ini" in text editor, add "maxCameraCount=NN" (NN = 9 to 16) in "CameraImageGigE" section as follows.

```

[[Logging]
imageLoggingEnabled=1

[SerialNormal]
enabled=1
portName=COM1:

[UdpNormal]
enabled=1

[TcpNormal]
enabled=1

[EtherNet IP]
enabled=1
; localMacAddress=00-00-00-00-00-00

[CameraImageGigE]
maxCameraCount=16
```



Precautions for Correct Use

A negative value is not allowed at "maxCameraCount", set positive integer.

● Settings for cameras with Camera Configuration Tool

Settings for cameras with "Camera Configuration Tool".

- 1 Launch the tool from Start menu - **OMRON** - **Camera Configuration Tool**.
- 2 Select camera from the list to each camera number (CameraNo).
When select CameraID cell, the connected camera list will be displayed.

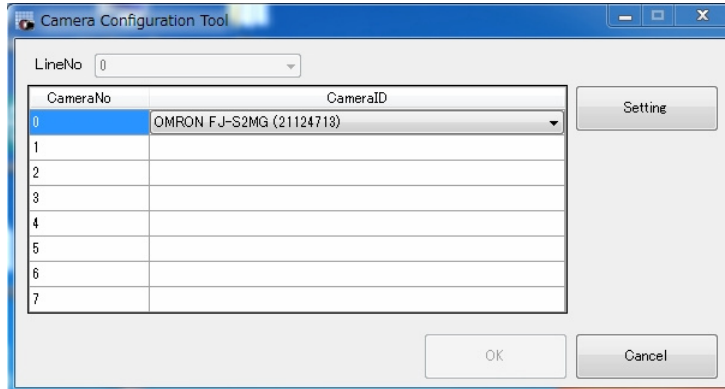

3 Click **OK**.

● Verify connected cameras

Open "System Settings", and verify that all the added cameras are displayed.

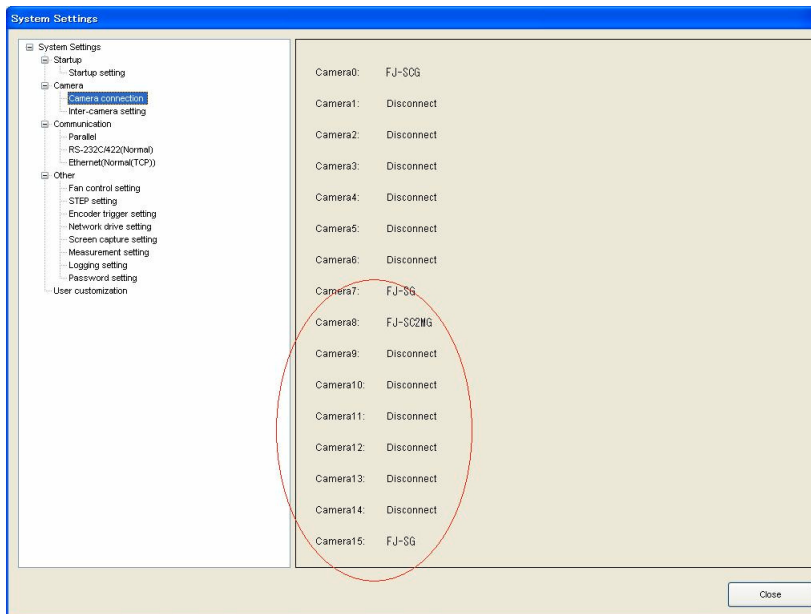

1-3 Setup of Camera & Software Vision (FJ-S□□□□2 Series)

1-3-1 Prepare hardware

System configuration:

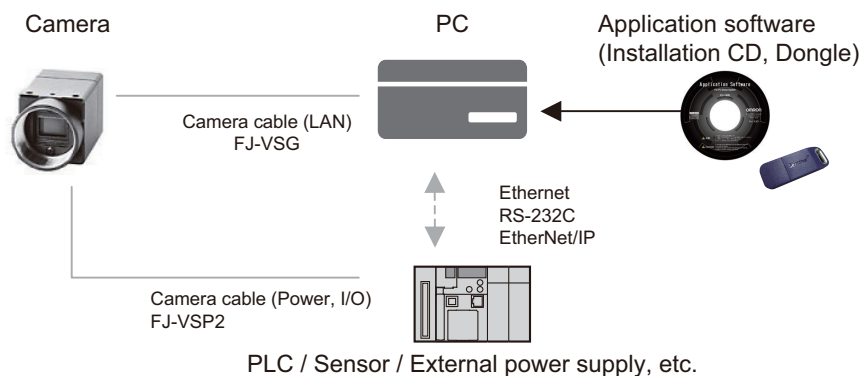

First prepare hardware components to construct the system.

- Required: PC
- Required: GigE Camera (in the quantity required)
- Required: Application software (Installation CD and Dongle)
- Required: Gigabit Ethernet adapter (PoE type is recommended)
- Required: Camera cable (LAN)
- As needed: Camera cable (Power, I/O)
- As needed: External power supply unit for cameras (In case PoE is not used)
- As needed: PoE Injector
- As needed: Switching HUB (In case multiple cameras are used)
- As needed: LAN cable

Shown below are the combinations of quantity of cameras, and type of power supply.

Index	Quantity of cameras	Power supply
1	1 unit	PoE Gigabit Ethernet adapter
2	1 unit	External power source
3	1 unit	PoE Injector
4	Multiple units	External Power supply unit (for each cameras)
5	Multiple units	PoE Switching HUB
6	Multiple units	PoE Injector

Pattern No.1

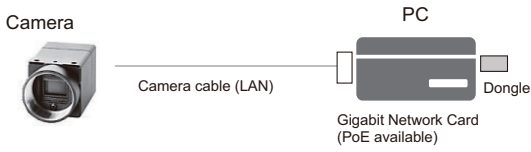

Pattern No.2

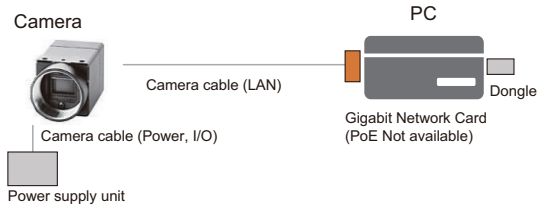

Pattern No.3

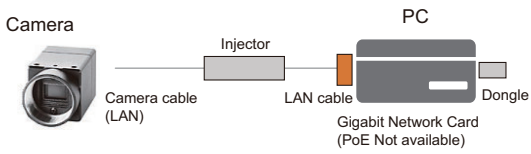

Pattern No.4

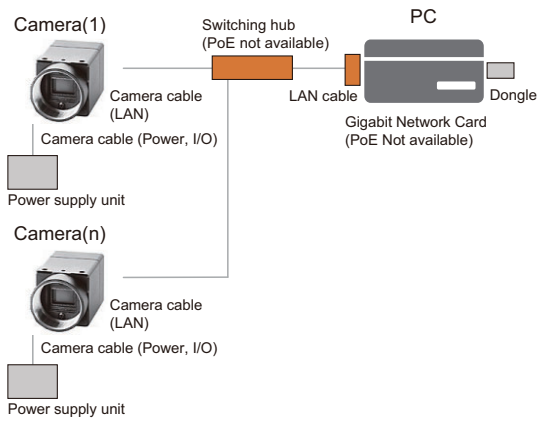

Pattern No.5

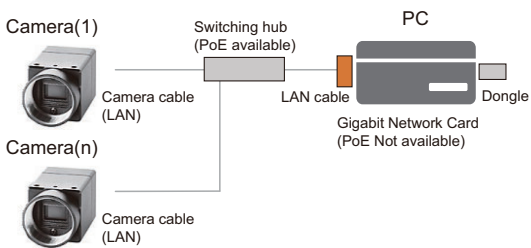

Pattern No.6

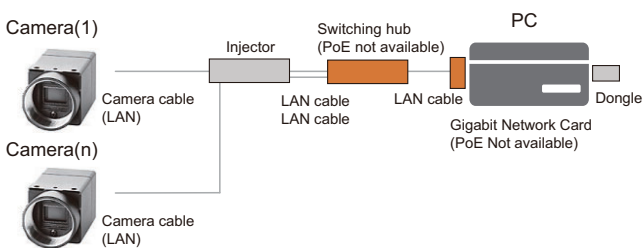



Precautions for Correct Use

The LAN network you use for communication with cameras should be used only for communication with the cameras.
Do not use it for communication with other devices.
Use only the cable designed specifically for the camera (FJ-VSP2) as the camera cable (Power, I/O). Do not use the FJ-VSP.



Additional Information

PoE(Power over Ethernet) is a technology for delivering electrical power via standard Ethernet cabling.

When PoE camera is connected to PoE power sourcing equipments, such as PoE switching hub or PoE injector, camera can be powered via network cable.

For FJ Series, the following cameras are PoE cameras.

- FJ-SG/FJ-SCG/FJ-S2MG/FJ-SC2MG
- FJ-SG2/FJ-SCG2/FJ-S2MG2/FJ-SC2MG2/FJ-S5MG2/FJ-SC5MG2

1-3-2 Install Gigabit ethernet adapter

Following manufacturer's instructions, install Gigabit ethernet adapter hardware and device driver software.

1-3-3 Install GigE camera device driver

Following the steps shown below, install device drivers of camera and dongle from installation CD.

Installation of device driver must be done by Administrator authority.

Displayed messages can have slight difference, depends on the version, or operating system on PC.

- 1 Insert installation CD into PC. Then setup program starts automatically.

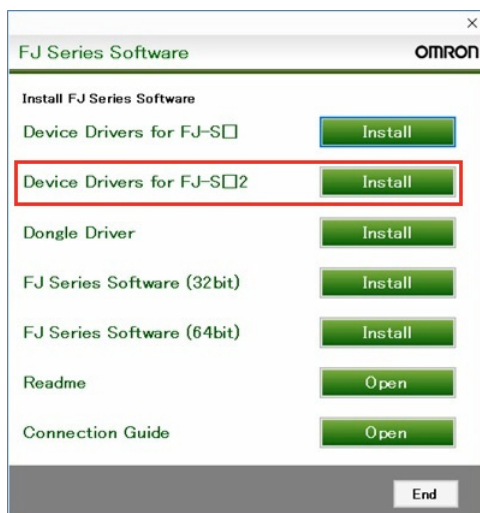

- 2 Click **Install** button for device driver. Then setup for camera device driver starts. Please install it with default option, if there is no special reason to change.

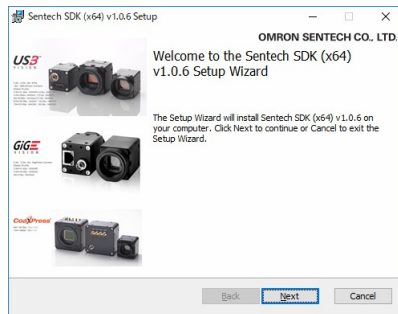

- 3** After installation of camera device driver, then setup for dongle device driver starts. Please install it with default option, if there is no special reason to change.

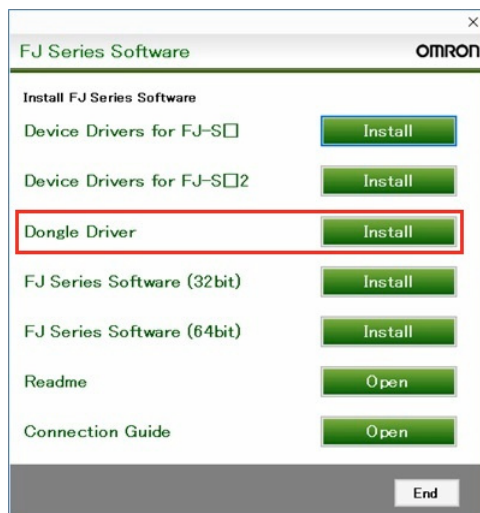

- 4** After installation of dongle device driver, return to setup program (step 1.). Click **End** button and restart PC.



Precautions for Correct Use

- Both FJ-S□□□□ and FJ-S□□□□2 cameras cannot be used at the same time from the PC.
- Please install either **Device Driver for FJ-S□** or **Device Driver for FJ-S□2**.

1-3-4 Configure Gigabit Ethernet adapter

To be able to connect the camera to the Ethernet card, you must configure Gigabit Ethernet adapter. The description in this section assume connecting one camera per one ethernet adapter. In case you need to connect multiple cameras, please refer to *Connecting multiple cameras* on page 1-25 described later.

Network settings

Configure network following the steps below.

- 1 Launch the tool from Start menu - **SentechSDK - StNICConfig**.

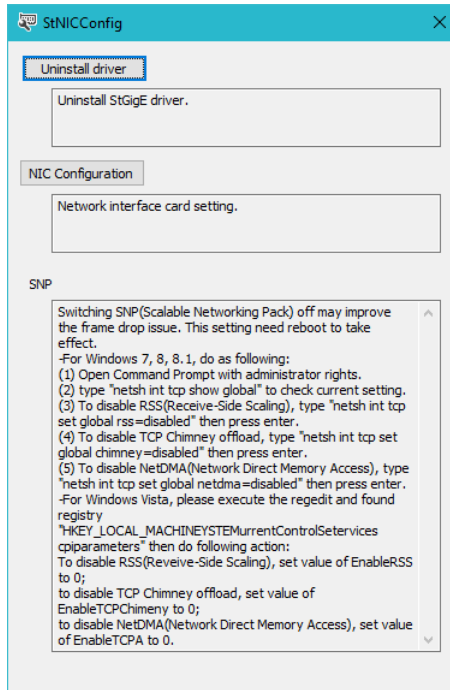

- 2 Click **NIC Configuration**.

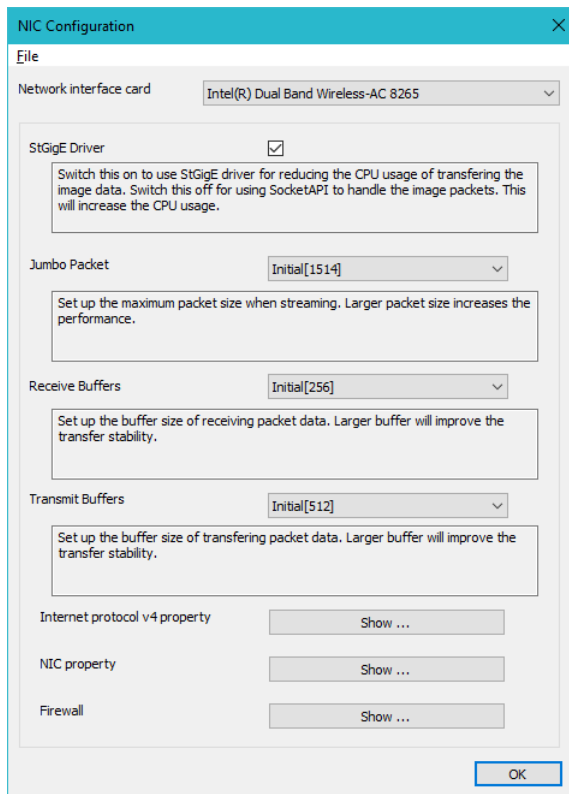

- 3 Set the Ethernet card to connect the GigE camera to **Network interface card**.

- 4 Set **Jumbo Packet (Jumbo Frame)**, **Receive Buffers**, and **Transmit Buffers** respectively. Your network adapter may show the parameters in different name, or some of the parameters are not supported.

Firewall settings

Disable the security settings for the Ethernet port to which the camera is connected.

1

1-3-5 Changing the PC Power Settings

1-3-5 Changing the PC Power Settings

- 1 Launch the tool from the Start Menu - **SentechSDK - StPowerCtrl**.
- 2 On the *StPowerCtrl* screen, uncheck all the items. (Disables the power saving setting.)

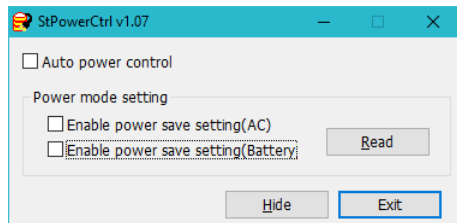

- 3 Click the **Read** button.
- 4 Click the **Exit** button.

1-3-6 Setup of camera connection

Setup the camera connection following the steps below.

- 1 Connect the camera cable (Power, I/O) to DC 12V power source.



Additional Information

For wiring, refer to the instruction manuals.

- 2 Connect the camera cable (LAN) and camera cable (Power, I/O) to FJ camera, and turn on the power.
- 3 Launch the tool from Start menu - **SentechSDK - GigECameraIPConfig**.
- 4 From the *Device Selection* screen, select the camera to use.

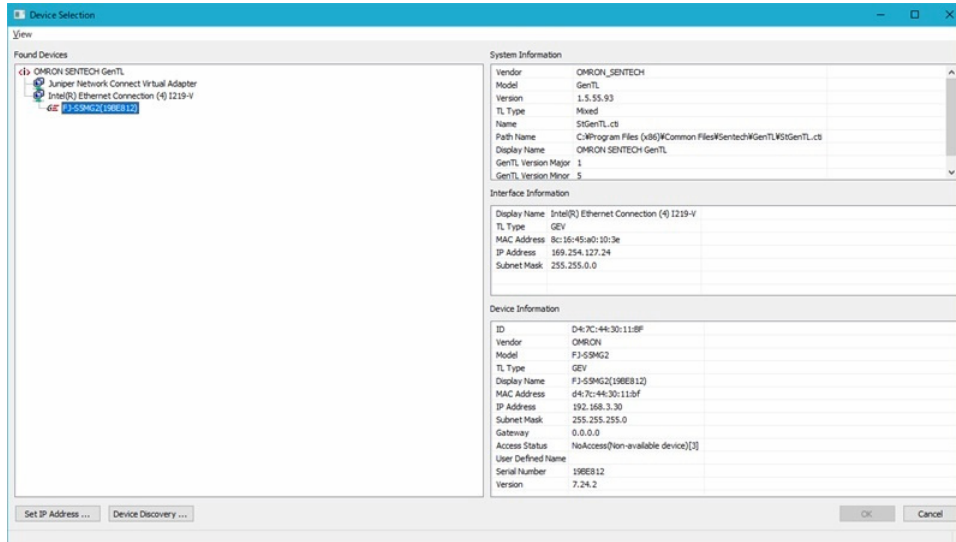

5 Select **Set IP Address**.

6 From the *Set IP Address* screen, set the IP address.

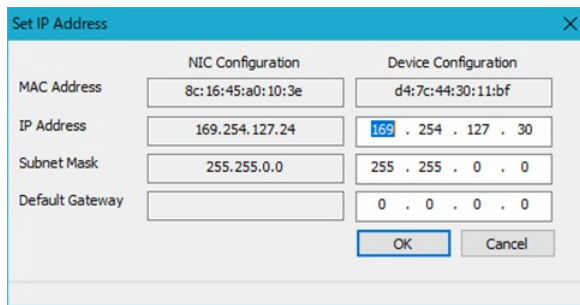

Additional Information

Since this setting is just a temporary buffer for the current value, the IP address will not be reflected if the power is turned off while in this state.

7 Click **OK**.

8 On the *Device Selection* screen, double click the camera you wish to use.

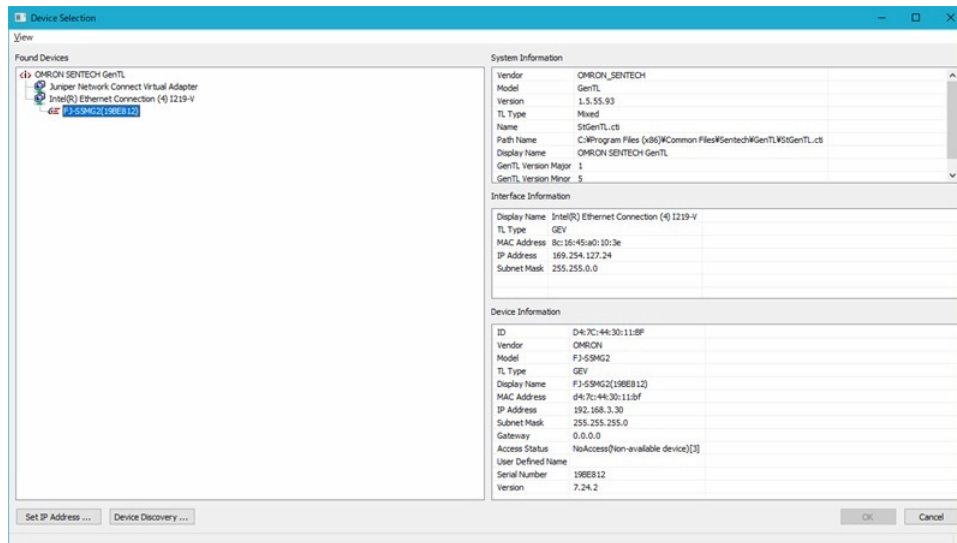

- 9 On the *GigE Camera IP Config* screen, uncheck *DHCP* and put a check in the box for *Persistent IP*.

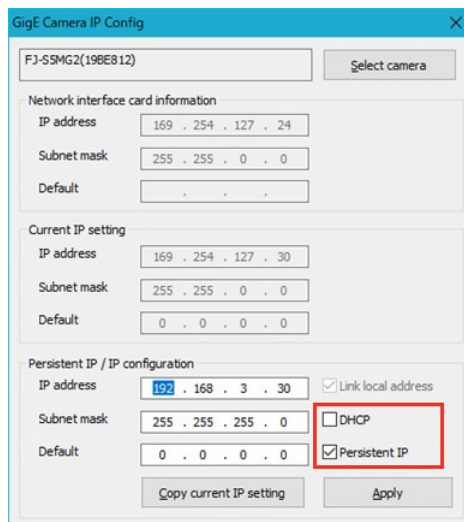

- 10 Enter the address and click **Apply**.



Additional Information

If it is different from the IP address set in Step 6, this setting will be reflected when the camera is restarted.

Connecting multiple cameras

There are following ways for connecting multiple cameras.

- Install multiple network adapters.
- Use network adapter with multiple ports.
- Use switching HUB.

Refer to *1-3-6 Setup of camera connection* on page 1-23 for connection settings.



Additional Information

For both cases, set persistent IP address for each cameras which is not duplicated with other devices.

In the case of using the PC with multiple Ethernet ports, each adapter must have IP address which network address is different from other Ethernet ports.

The network address can be calculated from the logical product (AND) between the IP address and network mask.

1-3-7 Setup of Software

Installation

Setup standard FJ software from installation CD, following the steps below.

- 1 Insert installation CD into PC. Then setup program starts automatically.

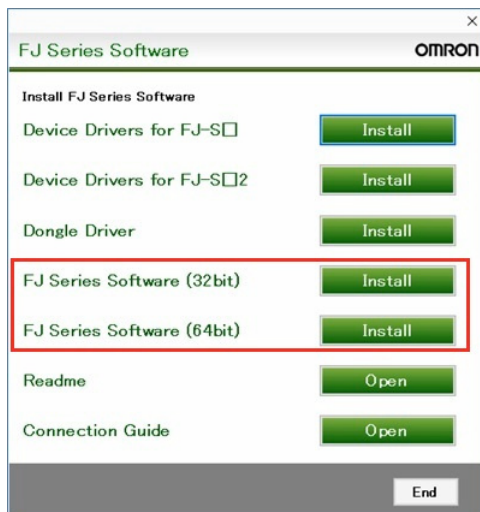

- 2 Click **Install** button for FJ Series Software. Then setup for camera device driver starts.



Precautions for Correct Use

- Install and use either 32-bit or 64-bit software according to your environment.

Assign a camera number

Following the steps below, assign a camera number for each camera connected.

- 1 Launch the tool from Start menu - **OMRON - Camera Configuration Tool**.
- 2 Select camera from the list to each camera number (CameraNo).
When select CameraID cell, the connected camera list will be displayed.

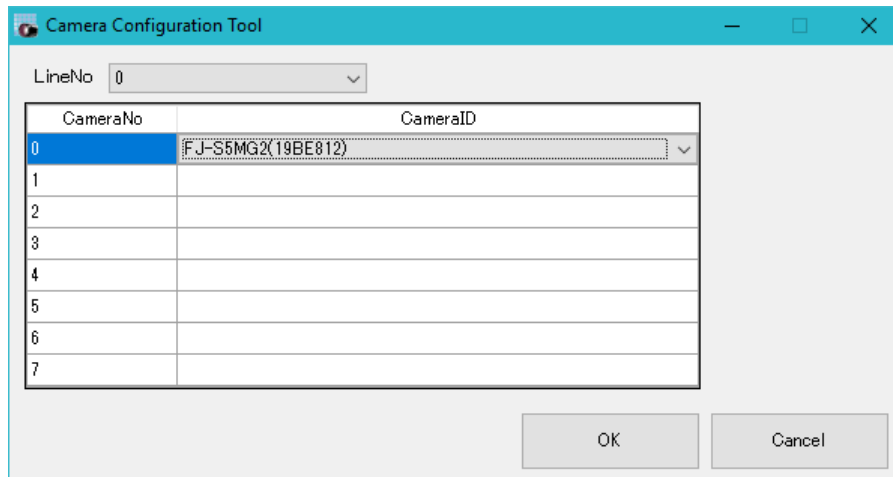

3 Click **OK**.

Detailed setting for cameras

- 1** Close the currently displayed **Camera Configuration Tool**.
- 2** Launch the tool from Start menu - **SentechSDK - StViewer**.
- 3** On the **Device Selection** screen, select the camera for detailed settings. Click the **OK** button to close the **Device Selection**.
- 4** In *StViewer*, select **Remote Device - User Set Control - User Set Selector** and select **User Set 0**.

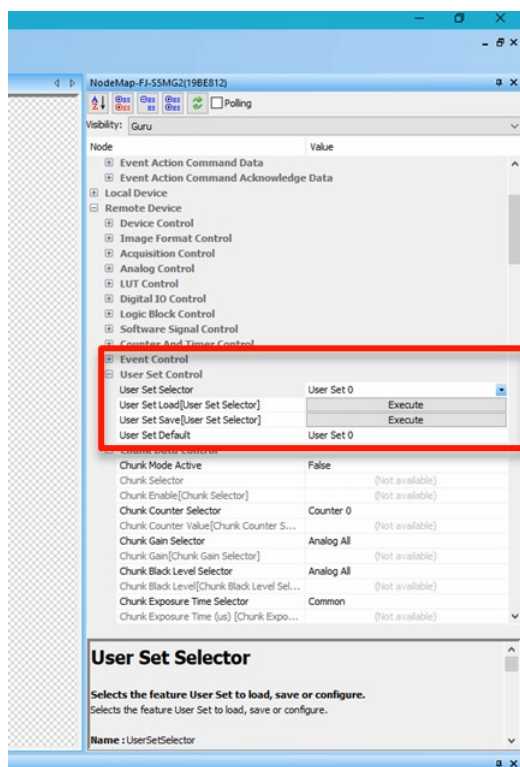

5 Set the parameters.

These are the parameters.

Remote Device

Item		Value [Default]	Description
Acquisition Control	Trigger Delay (μ s)	0 to 20000000 [0]	Set the time from recognizing trigger to releasing the shutter of a camera.
Digital IO Control	Line Inverter [Line Selector]	<ul style="list-style-type: none"> • [True] • False 	Invert polarity of the signal. <ul style="list-style-type: none"> • True: Positive • False: Negative When <i>Line0</i> is selected in <i>Line Selector</i> , the polarity of the trigger signal can be reversed. When <i>Line1</i> is selected, the polarity of the Output signal can be reversed.
	Line Debounce Time (μ s) [Line Selector]	0 to 10000 [1]	Set the pulse-width time for recognizing trigger of a camera. Set it after selecting <i>Line0</i> with <i>Line Selector</i> .
	Line Source [Line Selector]	<ul style="list-style-type: none"> • [FrameTriggerwait] • Timer 0 Active 	Set the type of signal to be output. <ul style="list-style-type: none"> • FrameTriggerwait: The signal which is ON while trigger signal can be input. • Timer 0 Active: The signal for strobe trigger. Set it after selecting <i>Line1</i> with <i>Line Selector</i> .
	Line Status [Line Selector]	<ul style="list-style-type: none"> • True • False 	If you check <i>Polling</i> at the top of the setting screen, you can monitor the signal status. <ul style="list-style-type: none"> • True: ON • False: OFF When <i>Line0</i> is selected in <i>Line Selector</i> , the Trigger Signal Status can be monitored. When <i>Line1</i> is selected, the Output Signal Status can be monitored.
Counter And Timer Control	Timer Delay (μ s) [Timer Selector]	0 to 16777215 [0]	This setting is valid when <i>Timer 0 Active</i> is selected for the Output Signal (Line Source [Line Selector]). Set the delay time.
	Timer Duration (μ s) [Timer Selector]	0 to 16777215 [1]	This setting is valid when <i>Timer 0 Active</i> is selected for the Output Signal (Line Source [Line Selector]). Set the pulse-width time.

Item		Value [Default]	Description
Transport Layer Control - GigEVision	GEV SCPD	0 to 4294967295 [6000] (Unit: Tick, FJ-S□□□□2 Camera: 1 [Tick] = 1 [ns])	Set the delay time of packets between. Set for preventing packet-loss because of connecting multiple cameras in one LAN. Set with GEV SCFTD.
	GEV SCFTD	0 to 4294967295 [0] (Unit: Tick, FJ-S□□□□2 Camera: 1 [Tick] = 1 [ns])	Set the delay time to transmit packets. Set for preventing packet-loss because of connecting multiple cameras in one LAN. Set with GEV SCPD.
Timer Trigger Source		-	Set to <i>Line0</i> when using a strobe trigger.



Precautions for Correct Use

Do not change any parameters other than those above.



Additional Information

In the FJ-S□□□□2 series, the packet size is automatically adjusted to an appropriate size according to the Ethernet card settings.

- 6** In *Remote Device - User Set Control - User Set Save*, click **Execute**.
- 7** Close the Tool.

● Initializing camera settings

- 1** Launch the tool from Start menu - **SentechSDK - StViewer**.
- 2** On the **Device Selection** screen, select the camera for initializing. Click the **OK** button to close the **Device Selection**.
- 3** In *Remote Device - Device Control - Device Reset*, click **Execute**. This will reset the setting to the factory default.
- 4** Close the Tool.

Start the application software

- 1** Connect the dongle of application software to the PC.
The LED of the connected dongle lights up.
- 2** Launch the application software from the Start Menu - **OMRON - FJ-SW**.



Precautions for Correct Use

- Install and use either 32-bit or 64-bit software according to your environment.

Configuration of Processing Item "Camera Image Input GigE"

Refer to *Section 2 Processing Item "Camera Image Input GigE"* on page 2-1.

Making measurement flow

You must allocate "Camera Image Input GigE" unit for each GigE cameras connected to the system. In each unit, you need to select camera to handle. (Example 1)

One camera can be handled by multiple Camera Image Input GigE units. In this case, each unit receives camera image with modified camera parameters following the measurement flow. (Example 2)

- Example 1: Add four Camera Image Input GigE units to use four cameras.



- Example 2: Input multiple images with different camera parameters from one camera, by adding multiple Camera Image Input GigE units.

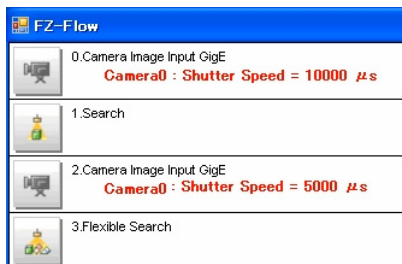

Additional Information

The image input time for the second and subsequent GigE cameras in the flow is approximately 50ms longer than that of the first one.

Others

Make the following settings as required depending on the system configuration.

- Set the External I/F Port No.
- Edit the FJ series setting file "FZ-Option.ini" and set the port number of the External I/F. The folder path depends on the installation method. (Example: "C:\Program Files\OMRON\FJ Software(x64)\Release_x64\FZ-Option.ini")

"FZ-Option.ini" defines the setting of FJ movement.

Main Identifications are below.

Section	Identification	Explanation
Logging	imageLoggingEnabled	Image logging Enable/Disable <ul style="list-style-type: none"> • 0: Disable • 1: Enable
SerialNormal	enabled	Serial communication Enable/Disable <ul style="list-style-type: none"> • 0: Disable • 1: Enable
	portName	Set the port No. to use. When port No. is lower than 10(X): COMX When port No. is higher than 10(YY): \\.\COMYY
UdpNormal	enabled	UDP communication Enable/Disable <ul style="list-style-type: none"> • 0: Disable • 1: Enable
TcpNormal	enabled	TCP communication Enable/Disable <ul style="list-style-type: none"> • 0: Disable • 1: Enable
EtherNetIP	enabled	EtherNetIP communication Enable/Disable <ul style="list-style-type: none"> • 0: Disable • 1: Enable
	localMacAddress	Describe MAC address in use by the format below. XX-XX-XX-XX-XX-XX



Precautions for Correct Use

- If the connected camera is changed, reset the parameters used in Camera Image Input GigE.
- If a scene data created with another camera and sensor controller is imported, there may be cases where the setting may be incompatible with the current camera. In that case, please go in to the Processing item Setting UI in the TDM Editor and change the setting to an appropriate value in that menu.
- The FJ software, Camera Configuration Tool and IP Configuration Tool will not function properly if they are all open and running at the same time.
When using any of these, always check that none of the others are currently open and in use.
- There may be settings in the Camera & Software Vision package that cannot be used due to related settings in the Operating System Settings - Communication - Address Setting.
When use Camera & Software Vision, It is necessary to connect with PC network at "Address setting".

1-3-8 Settings when connecting multiple GigE Cameras (over 9 units)

In its initial state, the maximum number of cameras is 8. Therefore the following change is required to connect 9 or more cameras. Maximum of 16 GigE cameras can be connected for use.

**Precautions for Correct Use**

The maximum number of cameras that can be connected will depend on factors such as the specifications of the PC and its System environment settings.

When you wish to connect and use multiple cameras, first check to make sure of the maximum number the system will support.

Setting for multiple camera units**● Editing FZ-Option.ini**

Editing "FZ-Option.ini" for setting.

Refer to *Others* on page 1-15 about FZ-Option.ini.

Open "FZ-Option.ini" in text editor, add "maxCameraCount=NN" (NN = 9 to 16) in "CameraImageGigE" section as follows.

```
[Logging]
imageLoggingEnabled=1

[SerialNormal]
enabled=1
portName=COM1:

[UdpNormal]
enabled=1

[TcpNormal]
enabled=1

[EtherNet IP]
enabled=1
; localMacAddress=00-00-00-00-00-00

[CameraImageGigE]
maxCameraCount=16
```

**Precautions for Correct Use**

A negative value is not allowed at "maxCameraCount", set positive integer.

● Settings for cameras with Camera Configuration Tool

Settings for cameras with "Camera Configuration Tool".

- 1** Launch the tool from Start menu - **OMRON - Camera Configuration Tool**.
- 2** Select camera from the list to each camera number (CameraNo).
When select CameraID cell, the connected camera list will be displayed.

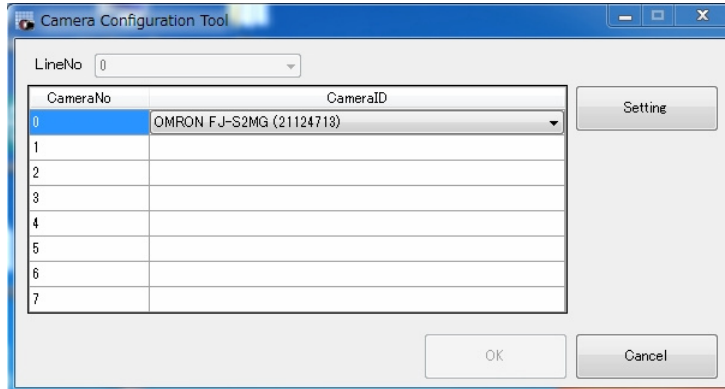

3 Click **OK**.

● **Verify connected cameras**

Open "System Settings", and verify that all the added cameras are displayed.

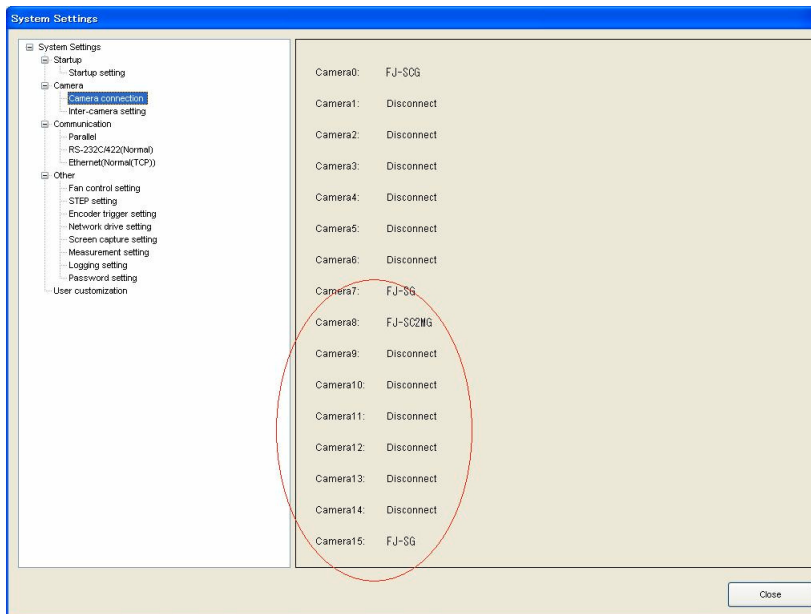

2

Processing Item "Camera Image Input GigE"

2

2-1	Overview	2-2
2-2	Settings	2-3
2-3	Detailed result display	2-5
2-4	Camera Image Input GigE Timing Chart	2-6

2-1 Overview

Description of **Camera Image Input GigE** processing item.

This section primarily describes those settings that differ from the standard **Camera Image Input** processing items.

2-2 Settings

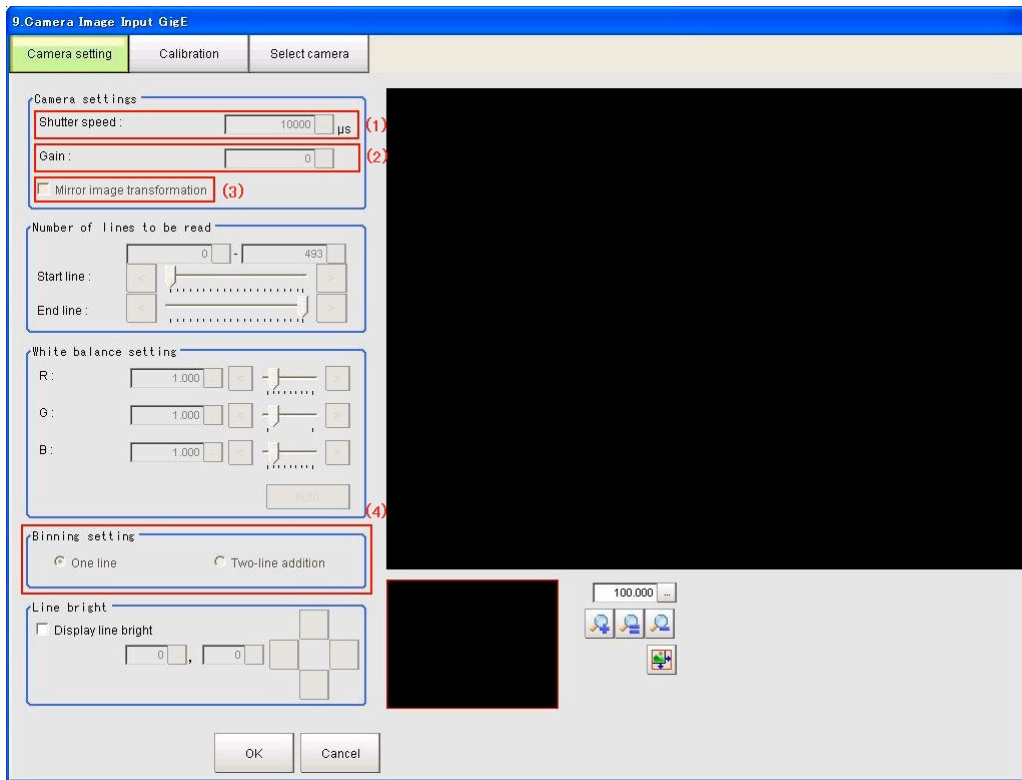

No.	Setting Item	Description	Range
(1)	Shutter speed	Select a shutter speed appropriate for the speed of the measurement object. If the moving speed of the measurement object is fast and the image is blurred, decrease the shutter speed.	*1
(2)	Gain	Increase this when the image cannot be brightened by the shutter speed, lens aperture, or illumination. Normally, the factory default settings can be used.	*1
(3)	Mirror image transformation	When this function is enabled, you can create a mirror image with the left and right sides reversed.	ON/OFF
(4)	Binning setting	Note that the Binning setting is for Monochrome cameras only. When Two line is selected, data is transferred two lines at a time. The effect of this is as follows. <ul style="list-style-type: none"> The size of the data becomes smaller so the Image Acquisition Time becomes shorter. Dark images can be made brighter. However resolution does become lower.	1 to 2

*1.

Camera	Shutter speed [μs]			Gain		
	Min	Max	Factory default	Min	Max	Factory default
FJ-SG	17	1000000	10000	210	920	210
FJ-SCG	17	1000000	10000	210	920	210
FJ-S2MG	25	1000000	10000	260	760	260
FJ-SC2MG	25	1000000	10000	260	760	260
FJ-S5MG	29	10000000	10000	0	400	0
FJ-SC5MG	29	10000000	10000	0	400	0

Camera	Shutter speed [μ s]			Gain		
	Min	Max	Factory default	Min	Max	Factory default
FJ-SG2/FJ-SCG2/ FJ-S2MG2/FJ-SC2MG2/ FJ-S5MG2/FJ-SC5MG2	1	16777215	10000	0	208	0

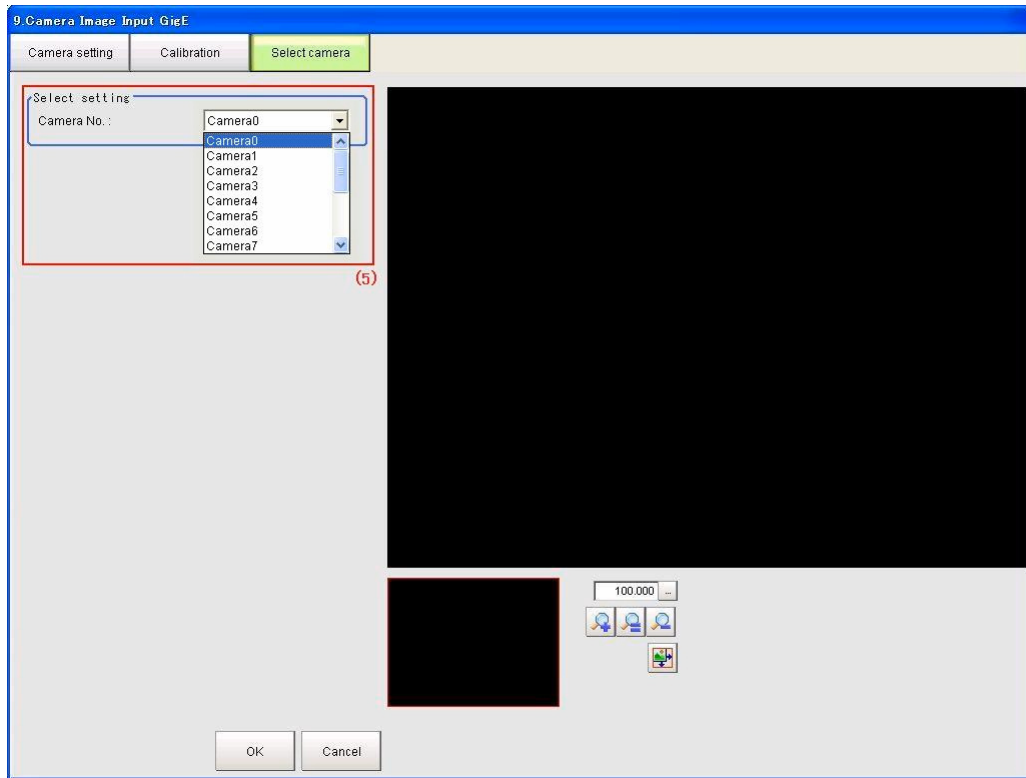

No.	Setting Item	Description	Range
(5)	Camera No.	Select the Camera No. from which to acquire an image.	0 to 15 *1

- *1. In the area where the Camera No. is selected, by default only up to 8 cameras can be set. When connecting 9 or more cameras, please refer to 1-2-7 *Settings when connecting multiple GigE Cameras (over 9 units)* on page 1-16.

2-3 Detailed result display

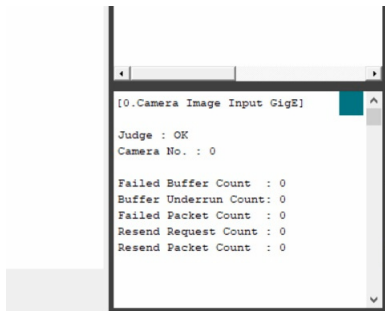

In the detailed result display window at the lower right of the main screen (when using the default layout), the following text is displayed.

Displayed item	Explanation
Judge	Judgement result
Camera No.	The Camera No. from which to acquire an image
Failed Buffer Count	Number of images that failed to be acquired
Buffer Underrun Count	This count (number) will increase if the trigger is input at a timing when the application cannot receive the image, such as when the driver's receive buffer is full and data is not discarded before the next trigger is received.
Failed Packet Count	The number of lost packets
Resend Request Count	The number of re-send requests
Resend Packet Count	Number of packets finally re-sent in response to a re-send request

2-4 Camera Image Input GigE Timing Chart

This section includes the timing chart for measurement executed with the TRG input of the camera.



Precautions for Correct Use

As shown in the figure below, the Measurement time displayed on the main screen does not include the Exposure time and Transfer time. On the other hand, when measurement is executed by the internal Measurement command, the Measurement time displayed does include those times, so it will be significantly different.

Number of cameras: One, Number of Image Input: Once

Image Conversion process is executed after the Image Transfer from the camera is completed.

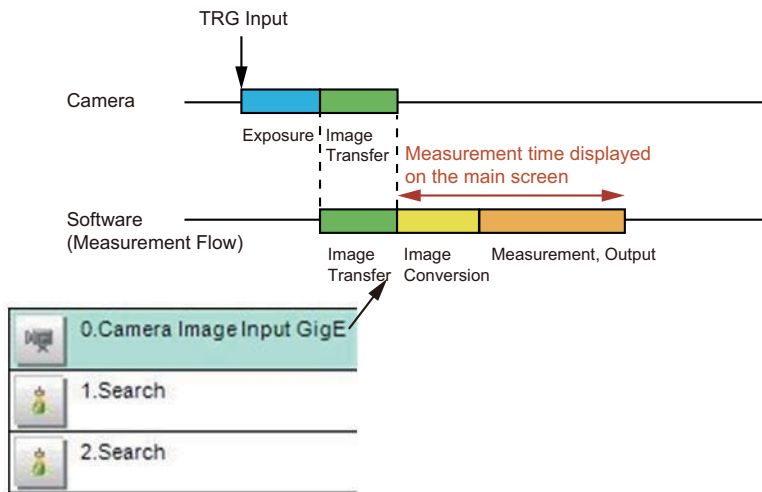

Number of cameras: One, Number of Image Input: Multiple

TRG Input is required for each Camera Image Input. The 2nd and subsequent TRG Input must be input within 3 seconds after the end of the previous measurement process. If TRG is not input within 3 seconds, a timeout error will occur.

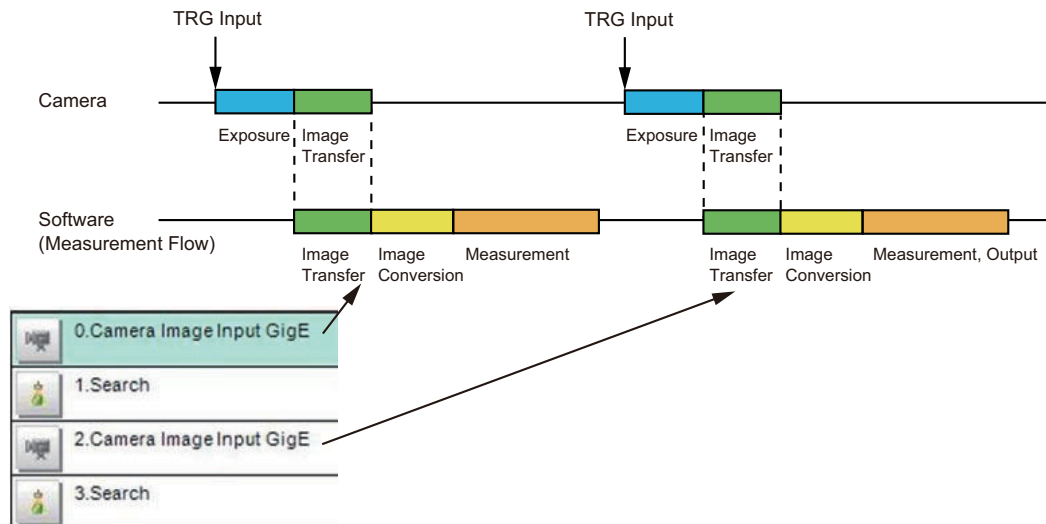

Number of cameras: Multiple, TRG Input: Common for all cameras

If TRG of Camera 0 and Camera 1 are input at the same time, Exposure of Camera 0 and Camera 1 will be executed at the same time. Processing done after Camera 1 Image Transfer will start after Camera 0 Measurement processing is completed.

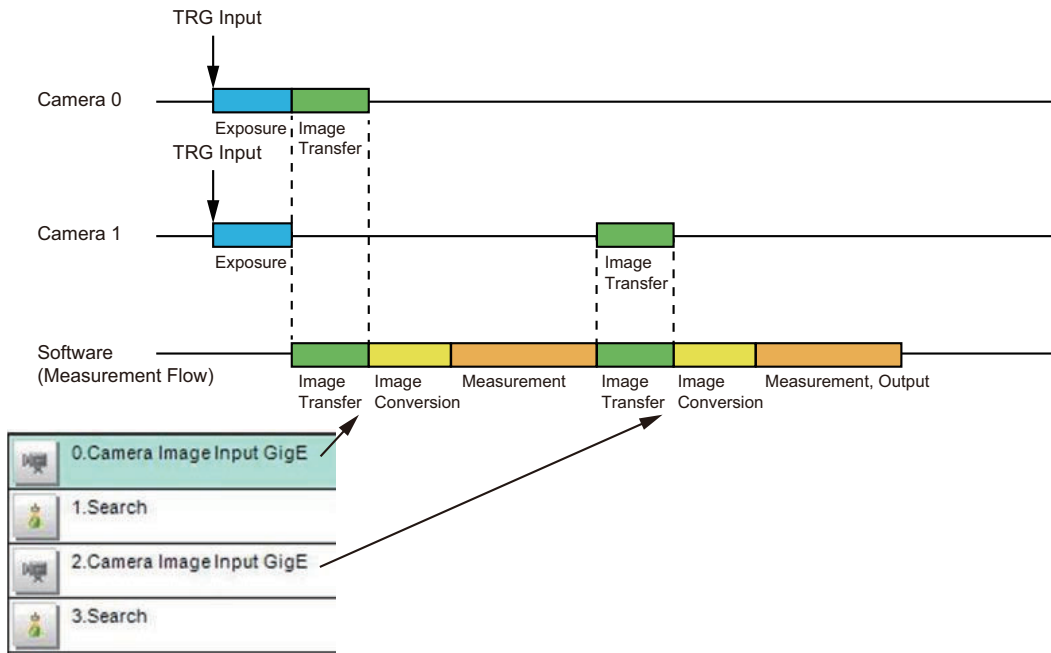

Number of cameras: Multiple, TRG Input: Different for each camera

The TRG input for Camera 1 must be input within 3 seconds after the Measurement process of Camera 0 is completed. If TRG is not input within 3 seconds, a timeout error will occur.

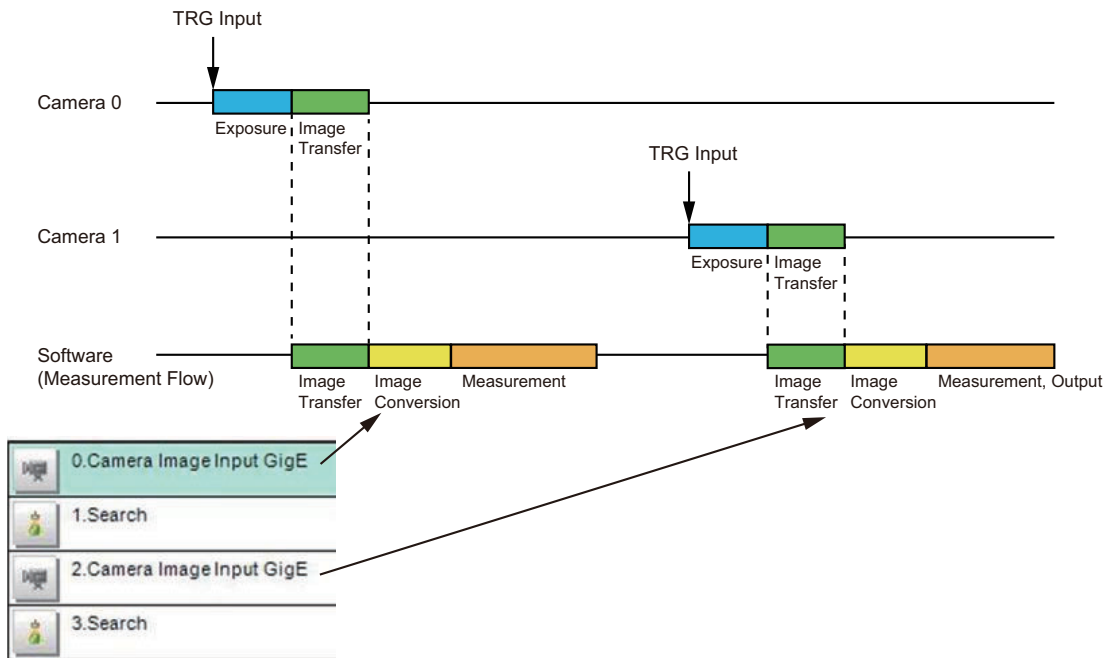

3

Troubleshooting

3-1	Troubleshooting	3-2
-----	-----------------------	-----

3-1 Troubleshooting

Symptom	Correction
When execute IP Configuration Tool in environment SysmacStudio is installed, multiple IP Addresses of each camera are displayed.	Execute the procedure below, disable "direct Ethernet connection function" of SysmacStudio. Select Start - OMRON - Communications Middleware Utilities - DirectEthernetUtility , and check <i>Disable the direct Ethernet connection function</i> , and click OK . When execute the procedure above, auto connection between PLC and other machines is disabled. In this case, refer to the manual of PLC.
Error message "CameraSetting error" appears.	When system detects disconnection with connecting GigE camera, system shows this error message. Please check these points: - If GigE cameras are not connected to power source correctly - If Network cable or other network devices are not correctly connected or stopped working - If System go to stand-by mode during FJ software is working
When launching the Camera Configuration Tool, "Failed to detect camera. Please check camera connection" is displayed and the camera cannot be assigned.	- The driver required for the camera type is not installed - A driver that does not match the camera type is installed - The camera IP address setting is wrong
When launching the application software, the dialog, "A camera connection status has been detected."	- The driver required for the camera type is not installed - A driver that does not match the camera type is installed - The camera IP address setting is wrong
Error message appears when IP Configuration Tool starts soon after installed.	Environment variable may be not reflected. Restart PC and retry, please.
Error message appears when suspend or hibernate PC.	In Camera & Software Vision, suspending or hibernating PC when processing is not supported. Use this system under setting of suspending and hibernating disabled.

OMRON Corporation Industrial Automation Company

Kyoto, JAPAN

Contact : www.ia.omron.com

Regional Headquarters

OMRON EUROPE B.V.

Wegalaan 67-69, 2132 JD Hoofddorp
The Netherlands
Tel: (31) 2356-81-300 Fax: (31) 2356-81-388

OMRON ASIA PACIFIC PTE. LTD.

438B Alexandra Road, #08-01/02 Alexandra
Technopark, Singapore 119968
Tel: (65) 6835-3011 Fax: (65) 6835-3011

OMRON ELECTRONICS LLC

2895 Greenspoint Parkway, Suite 200
Hoffman Estates, IL 60169 U.S.A.
Tel: (1) 847-843-7900 Fax: (1) 847-843-7787

OMRON (CHINA) CO., LTD.

Room 2211, Bank of China Tower,
200 Yin Cheng Zhong Road,
PuDong New Area, Shanghai, 200120, China
Tel: (86) 21-6023-0333 Fax: (86) 21-5037-2388

Authorized Distributor:

©OMRON Corporation 2020-2025 All Rights Reserved.
In the interest of product improvement,
specifications are subject to change without notice.

Cat. No. Z428-E1-03 0625